



DIGITAL WORKSTATION

Tyros5

Tyros5-76 Tyros5-61

Reference Manual

This Reference Manual explains advanced features of the Tyros5 that are not explained in the Owner's Manual. Please read the Owner's Manual first, before reading this Reference Manual.



Contents

* Each chapter in this Reference Manual corresponds to the relevant chapters in the Owner's Manual.

1	Voices – Playing the Keyboard –	4
	Voice Types (Characteristics)	4
	Selecting GM, XG and Other Voices	6
	Touch Response and Effect-Related Settings	7
	Pitch-Related Settings	10
	Editing Voices (Voice Set)	12
	Editing Organ Voices (Organ World)	17
	Editing Ensemble Voices (Ensemble Voice Edit).....	19
2	Styles – Playing Rhythm and Accompaniment –	25
	Selecting the Chord Fingering Type	26
	Style Playback Related Settings.....	28
	Memorizing Original Settings to a One Touch Setting	30
	Creating/Editing Styles (Style Creator)	31
3	Multi Pads – Adding Musical Phrases to Your Performance –	46
	Multi Pad Creating (Multi Pad Creator)	46
	Multi Pad Editing.....	48
4	Songs – Recording Your Performances as MIDI Songs –	50
	Editing Music Notation Settings	51
	Editing Lyrics/Text Display Settings.....	53
	Using the Auto Accompaniment Features with Song Playback.....	54
	Song Playback Related Parameters (Repeat Settings, Channel Settings, Guide Function)	55
	Creating/Editing Songs (Song Creator)	59
5	Audio Recorder/Player – Recording and Playback Audio Files –	76
	Recording Your Performance	76
	Converting a file.....	80
	Editing the Recorded Data (Multi Track Recording File).....	82
	Re-recording the Multi Track Recording File	84
	Setting the Start/End Points of the Audio (Multi Track Recording File)	87
	Playlist Mode.....	88
6	Music Finder – Calling Up Ideal Panel Settings for Your Performance –	91
	Creating a Set of Favorite Records.....	91
	Editing Records.....	92
	Saving the Records as a Single File (Music Finder File)	93
7	Registration Memory – Saving and Recalling Custom Panel Setups –	95
	Editing a Registration Memory	95
	Disabling Recall of Specific Items (Freeze)	96
	Calling Up Registration Memory Numbers in Order (Registration Sequence).....	97
8	Microphone – Adding Harmony Vocals and Synth Vocoder to Your Singing –	100
	Vocal Harmony and Talk Setting	100
	Making and Saving the Microphone Settings (Vocal/Talk)	101
	Setting and Editing Vocal Harmony Types	104
	Editing the Synth Vocoder Types.....	111

9	Mixing Console – Editing the Volume and Tonal Balance –	115
	Editing VOL/VOICE Parameters	115
	Editing FILTER Parameters	116
	Editing TUNE Parameters.....	117
	Editing EFFECT Parameters	118
	Editing EQ Parameters	122
	Editing Master Compressor Settings	123
	Line Out Settings	124
	Block Diagram.....	125
10	Utility – Making Global Settings –	126
	CONFIG 1	126
	CONFIG 2	128
	MEDIA.....	129
	OWNER	130
	SYSTEM RESET	131
11	Connections – Using Your Instrument with Other Devices –	133
	Footswitch/Foot Controller Settings.....	133
	MIDI Settings	136
	MFC10 Settings	142
	Connecting to a Network (Bundled USB Wireless LAN Adaptor)	144
	Appendix	148
	Expansion Pack Related Operations	148
	Index	150

Using the PDF manual

- To quickly jump to items and topics of interest, click on the desired items in the “Bookmarks” index to the left of the main display window. (Click the “Bookmarks” tab to open the index if it is not displayed.)
- Click the page numbers that appear in this manual to go directly to the corresponding page.
- Select “Find” or “Search” from the Adobe Reader “Edit” menu and enter a keyword to locate related information in the document.

NOTE

The names and positions of menu items may vary according to the version of Adobe Reader being used.

- The illustrations and LCD screens as shown in this manual are for instructional purposes only, and may appear somewhat different from those on your instrument. Note that all display examples shown in this manual are in English.
- The company names and product names in this manual are the trademarks or registered trademarks of their respective companies.

Contents

Voice Types (Characteristics)	4
Selecting GM, XG and Other Voices	6
Touch Response and Effect-Related Settings	7
• Setting the Touch Response of the Keyboard.....	7
• Using Keyboard Harmony/Echo	8
Pitch-Related Settings	10
• Fine-tuning the Pitch of the Entire Instrument.....	10
• Scale Tuning.....	10
• Changing the Part Assignment of the TRANSPOSE Buttons	11
Editing Voices (Voice Set)	12
• Editable Parameters in the VOICE SET Displays.....	13
• Disabling Automatic Selection of Voice Sets (Effects, etc.)	16
Editing Organ Voices (Organ World)	17
Editing Ensemble Voices (Ensemble Voice Edit)	19

Voice Types (Characteristics)

The particular type of Voice is indicated at the upper left of the Voice name in the Voice Selection display. The defining characteristics of these Voices and their performance advantages are described below.



<p>S.Art! (Super Articulation)</p>	<p>These Voices provide many benefits with great playability and expressive control in real time. For example, with the Saxophone Voice, if you play a C and then a D in a very legato way, you will hear the note change seamlessly, as though a saxophone player played it in a single breath. Similarly with the Concert Guitar Voice and play the D note strongly, the D note would sound as a “hammer on,” without the string being plucked again. Depending on how you play, other effects such as “shaking” or breath noises (for the Trumpet Voice), or finger noises (for the Guitar Voice) are produced.</p> <p>For details on how to best play each S.Art! Voice, call up the information window (pressing the [6 ▼] (INFO) button in the Voice Selection display).</p>
<p>S.Art2! (Super Articulation2)</p>	<p>For wind instrument Voices and Violin Voices, a special technology called AEM (see below) has been used, which features detailed samples of special expressive techniques used on those specific instruments—to bend or slide into notes, to “join” different notes together, or to add expressive nuances at the end of a note, etc. You can add these articulations by playing legato or non-legato, or by jumping in pitch by around an octave. For example, using the Clarinet Voice, if you hold a C note and play the Bb above, you’ll hear a glissando up to the Bb. Some “note off” effects are also produced automatically when you hold a note for over a certain time. Each S.Art2! Voice has its own default vibrato setting, so that when you select a S.Art2! Voice, the appropriate vibrato is applied regardless of the Modulation wheel position. You can adjust the vibrato by moving the Modulation wheel.</p> <p>For details on how to best play each S.Art2! Voice, call up the information window (pressing the [6 ▼] (INFO) button in the Voice Selection display).</p>
<p>Live!</p>	<p>These acoustic instrument sounds were sampled in stereo, to produce a truly authentic, rich sound—full of atmosphere and ambience.</p>

Cool!	These Voices use sophisticated programming to capture the dynamic textures and subtle nuances of electric instruments.
Sweet!	These acoustic instrument sounds also benefit from Yamaha’s sophisticated technology—and feature a finely detailed and natural sound.
Drums	Various drum and percussion sounds are assigned to individual keys, letting you play the sounds from the keyboard.
SFX	Various special effect sounds and percussion sounds are assigned to individual keys, letting you play the sounds from the keyboard.
Live! Drums	These are high-quality drum sounds that take full advantage of Stereo Sampling and Dynamic Sampling.
Live! SFX	These are various high-quality special effect sounds and percussion sounds that take full advantage of Stereo Sampling and Dynamic sampling.
Organ Flutes!	These authentic organ Voices let you adjust the various footages and craft your own original organ sounds. See page 17 for details.
MegaVoice	These Voices make special use of velocity switching. Each velocity range (the measure of your playing strength) has a completely different sound. For example, a guitar MegaVoice includes the sounds of various performance techniques. In conventional instruments, different Voices having those sounds would be called up via MIDI and played in combination to achieve the desired effect. However, now with MegaVoices, a convincing guitar part can be played with just a single Voice, using specific velocity values to play the desired sounds. Because of the complex nature of these Voices and the precise velocities need to play the sounds, they’re not intended for playing from the keyboard. They are, however, very useful and convenient when creating MIDI data—especially when you want to avoid using several different Voices just for a single instrument part.

 **NOTE**

S.Art!, S.Art2! and Mega Voices are not compatible with other instrument models. For this reason, any Song or Style you’ve created on this instrument using these Voices will not sound properly when played back on the instruments which do not have these types of Voices.

 **NOTE**

S.Art!, S.Art2! and Mega Voices sound differently depending on keyboard range, velocity, touch, etc. Hence, if you apply a HARMONY/ECHO effect, change the transpose setting or change the Voice Set parameters, unexpected or undesired sounds may result.

 **NOTE**

The characteristics of S.Art2! Voices (default vibrato setting and articulation effects applied by the [ART] buttons) are effective for real-time performance; however, these effects may not be completely reproduced when you play back a MIDI Song which has been recorded using S.Art2! Voices.

For a list of preset Voices of this instrument, refer to the “Voice List” in the Data List, available at the online Yamaha Library.

Converting the Voices of a MIDI Song to MegaVoices (MEGAEnhancer)

MEGAEnhancer is a software program that converts XG/GM song data (Standard MIDI File) to song data specially enhanced to be played back using an instrument or tone generator containing MegaVoices. With the use of the sophisticated MegaVoices, MEGAEnhancer automatically makes conventional song files with guitar, bass, and other parts sound much more realistic and authentic. MEGAEnhancer can be downloaded from the Yamaha website.

<http://download.yamaha.com/>

AEM Technology

When you play the piano, pressing a “C” key produces a definite and relatively fixed C note. When you play a wind instrument, however, a single fingering may produce several different sounds depending on the breath strength, the note length, the adding of trills or bend effects, and other performance techniques. Also, when playing two notes continuously—for example “C” and “D”—these two notes will be smoothly joined, and not sound independent as they would on a piano.

AEM (Articulation Element Modeling) is the technology for simulating this characteristic of instruments. During performance, the most appropriate sound samples are selected in sequence in real time, from huge quantities of sampled data. They are smoothly joined and sounded—as would naturally occur on an actual acoustic instrument.

This technology to smoothly join different samples enables the application of realistic vibrato. Conventionally on electronic musical instruments, vibrato is applied by moving the pitch periodically. AEM technology goes much further by analyzing and disaggregating the sampled vibrato waves, and smoothly joins the disaggregated data in real time during your performance. If you move the Modulation wheel when you play the S.Art2! Voice (using AEM technology), you can also control the depth of the vibrato, and still maintain remarkable realism.

Selecting GM, XG and Other Voices

This instrument features Voices provided specially for Style playback and XG/GM compatibility. These Voices cannot be called up directly from the VOICE category selection buttons. However, they can be called up as described below.

- 1** Press the **PART SELECT** button corresponding to the Part you want to use.
- 2** Press one of the **VOICE** category selection buttons (other than the **[ORGAN WORLD]**, **[ENSEMBLE]** and **[EXPANSION/USER]** buttons) to call up the Voice Selection display.
- 3** Press the **[8 ▲]** (UP) button to call up the Voice categories.

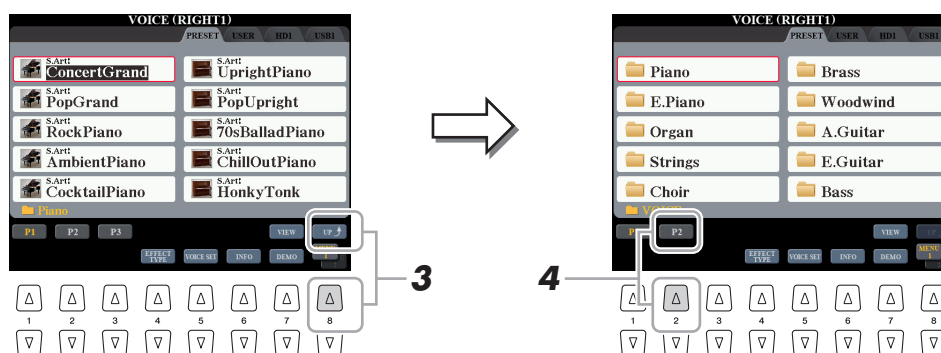

- 4** Press the **[2 ▲]** (P2) button to display Page 2.
- 5** Press the desired **[A]–[J]** button to call up the Voice Selection display of GM&XG Voices, GM2 Voices, etc.
- 6** Select the desired Voice.

NOTE

You can also find the “Legacy” folder in this display. This folder contains previous Yamaha keyboards’ Voices (such as Tyros, Tyros2, Tyros3, Tyros4, etc.) for data compatibility with other models.

Touch Response and Effect-Related Settings

Setting the Touch Response of the Keyboard

Touch Response determines how the sound responds to your playing strength. The touch response type becomes the common setting for all Voices.

NOTE

Some Voices are purposely designed without touch response, in order to emulate the true characteristics of the actual instrument (for example, conventional organs, which have no touch response).

1 Call up the operation display.

[FUNCTION] → [D] CONTROLLER → TAB [◀][▶] KEYBOARD/PANEL

2 Use the [A]/[B] buttons to select the desired parameter: “1 INITIAL TOUCH” or “2 AFTER TOUCH.”

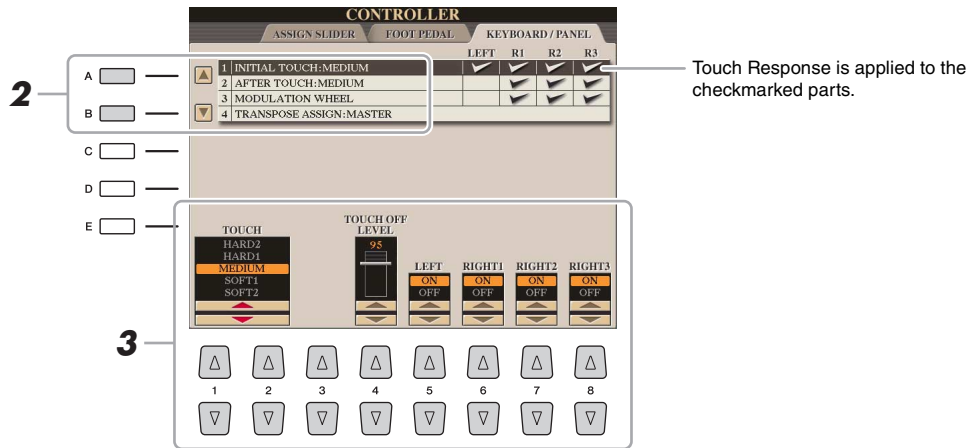

3 Use the [1 ▲▼]–[8 ▲▼] buttons to set the touch response.

1 INITIAL TOUCH

[1 ▲▼]/ [2 ▲▼]	TOUCH	Determines the Initial Touch Response type. HARD 2: Requires strong playing to produce high volume. Best for players with a heavy touch. HARD 1: Requires moderately strong playing for higher volume. MEDIUM: Standard Touch Response. SOFT 1: Produces high volume with moderate playing strength. SOFT 2: Produces relatively high volume even with light playing strength. Best for players with a light touch.
[4 ▲▼]	TOUCH OFF LEVEL	Determines the fixed volume level when Touch is set to “OFF.”
[5 ▲▼]– [8 ▲▼]	LEFT–RIGHT3	Turns Initial Touch on or off for each keyboard part.

2 AFTER TOUCH

[1 ▲▼]/ [2 ▲▼]	TOUCH	Determines the After Touch response type. HARD: Relatively strong After Touch pressure is needed to produce changes. MEDIUM: Produces a fairly standard After Touch response. SOFT: Allows you to produce relatively large changes with very light After Touch pressure.
[5 ▲▼]– [8 ▲▼]	LEFT–RIGHT3	Turns After Touch on or off for each keyboard part.

Using Keyboard Harmony/Echo

You can select the desired Harmony/Echo effect from a variety of types.

- 1** Turn the [HARMONY/ECHO] button on.
- 2** Call up the operation display.
[FUNCTION] → [F] HARMONY/ECHO
- 3** Use the [1 ▲▼]–[3 ▲▼] buttons to select the Harmony/Echo type.

The Harmony/Echo types are divided into three groups (Harmony Types, Multi Assign Type, and Echo types), depending on the particular effect applied.

- 4** Use the [4 ▲▼]–[8 ▲▼] buttons to select various Harmony/Echo settings.

The available settings differ depending on the Harmony/Echo type.

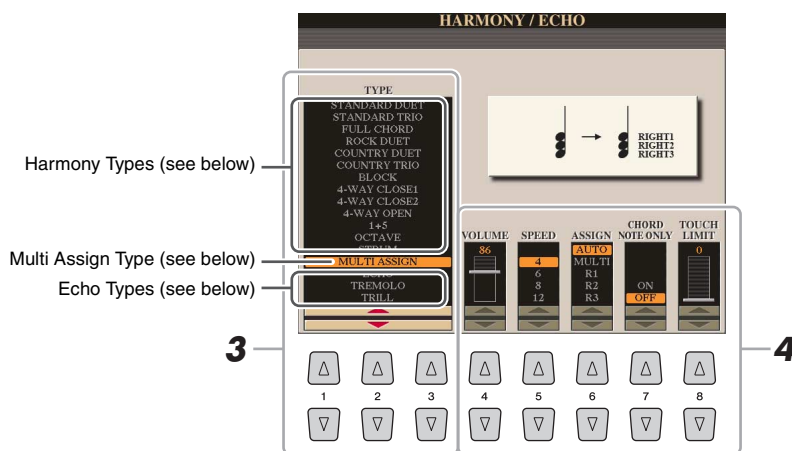

NOTE

When the [MONO] button is turned to on or you use the S.Art1/S.Art2! Voices, the Harmony/Echo effect may not work properly.

NOTE

The available Harmony/Echo types differ when an Ensemble Voice is selected.

[4 ▲▼]	VOLUME	This parameter is available for all types with the exception of “Multi Assign.” It determines the volume level of the Harmony/Echo notes generated by the Harmony/Echo effect.
[5 ▲▼]	SPEED	This parameter is only available when Echo, Tremolo, or Trill is selected in Type above. It determines the speed of the Echo, Tremolo, and Trill effects.
[6 ▲▼]	ASSIGN	Determines the keyboard Part that the effect is assigned. AUTO: Applies the effect to the part for which PART ON/OFF is on. When more than one parts are on, the RIGHT 1 part is given priority over the RIGHT 2/3 part. In a similar way the RIGHT 2 part is given priority over the RIGHT 3 part. MULTI: When more than one parts are on, the note played on the keyboard is sounded by the RIGHT 1 part and the harmonies (effect) are divided to the RIGHT 1, RIGHT 2 and RIGHT 3 parts. When only one part is on, the note played on the keyboard and effect are sounded by that part. R1–R3: Applies the effect to the selected part (RIGHT 1, RIGHT 2 or RIGHT 3). NOTE This parameter is not available for the Multi Assign type.
[7 ▲▼]	CHORD NOTE ONLY	This parameter is available when one of the Harmony Types is selected. When this is set to “ON,” the Harmony effect is applied only to the notes (played in the right-hand section of the keyboard) that belongs to a chord played in the chord section of the keyboard.
[8 ▲▼]	TOUCH LIMIT	This parameter is available for all types with the exception of “Multi Assign.” It determines the lowest velocity value at which the harmony note will sound. This allows you to selectively apply the harmony by your playing strength, letting you create harmony accents in the melody. The harmony effect is applied when you play the key strongly (above the set value).

■ Harmony Types

The harmony effect is applied to the note played in the right-hand section of the keyboard according to the chord specified in the chord or left-hand section shown below.

You can make these different Split Point settings according to your performance preferences.

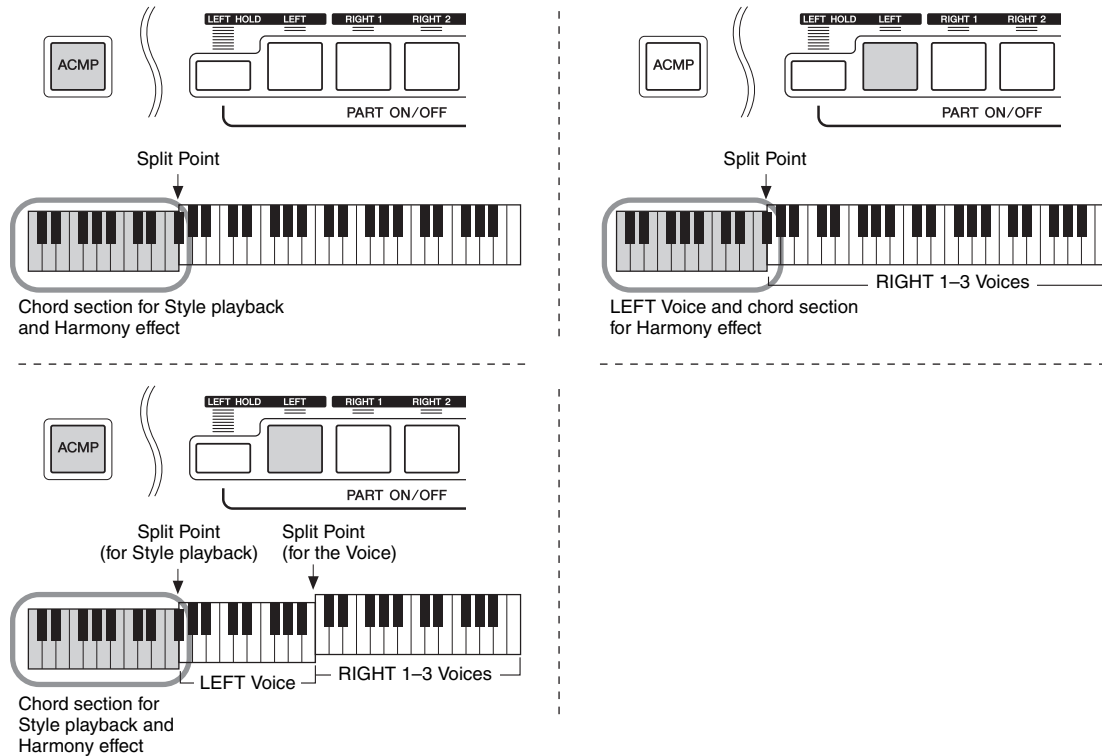

NOTE

The "1+5" and "Octave" settings are not affected by the chord.

NOTE

The actual operation depends on the Split Point settings. For more information, refer to "Specifying Chords with Your Right Hand while Playing Bass with Your Left Hand" in the Owner's Manual.

■ Multi Assign Type

The Multi Assign effect automatically assigns the notes of chords you play on the right-hand section of the keyboard to separate parts (Voices). For example, if you play a three-note chord, the first note you press is played by the RIGHT 1 Voice, the second by the RIGHT 2 Voice, and the third by the RIGHT 3 Voice. The Multi Assign effect is not affected by the [ACMP] and LEFT part on/off status.



■ Echo Types

The Echo, Tremolo or Trill effect is applied to the note played in the right-hand section of the keyboard in time with the currently set tempo, regardless of the [ACMP] and the LEFT part on/off status. Keep in mind that Trill works when you hold down two notes on the keyboard simultaneously (or the last two notes, if more than two notes are held), and it plays those notes alternately.

Pitch-Related Settings

Fine-tuning the Pitch of the Entire Instrument

You can fine-tune the pitch of the entire instrument such as the keyboard, Style and Song parts (except the keyboard part played by the Drum Kit or SFX Kit Voices, and audio playback)—a useful feature when playing the Tyros5 along with other instruments or CD music.

1 Call up the operation display.

[FUNCTION] → [A] MASTER TUNE/SCALE TUNE → TAB [◀][▶] MASTER TUNE

2 Use the [4 ▲▼]/[5 ▲▼] buttons to set the tuning in 0.2 Hz steps.

Press both [▲] and [▼] buttons (of 4 and 5) simultaneously to reset the value to the factory setting of 440.0 Hz.

Scale Tuning

You can select various scales for playing in custom tunings for specific historical periods or music genres.

1 Call up the operation display.

[FUNCTION] → [A] MASTER TUNE/SCALE TUNE → TAB [◀][▶] SCALE TUNE

2 Use the [A]/[B] buttons to select the desired scale.

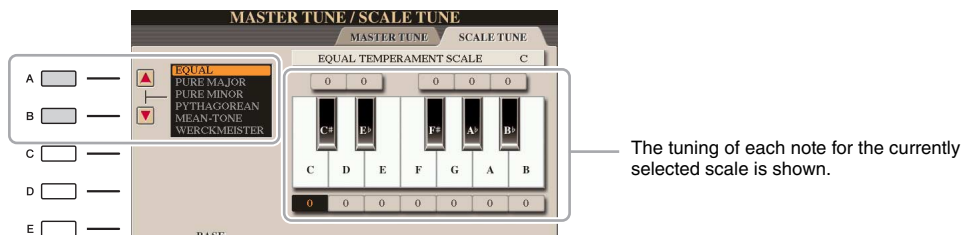

Preset Scale types

EQUAL	The pitch range of each octave is divided equally into twelve parts, with each half-step evenly spaced in pitch. This is the most commonly used tuning in music today.
PURE MAJOR, PURE MINOR	These tunings preserve the pure mathematical intervals of each scale, especially for triad chords (root, third, fifth). You can hear this best in actual vocal harmonies—such as choirs and a cappella singing.
PYTHAGOREAN	This scale was devised by the famous Greek philosopher and is created from a series of perfect fifths, which are collapsed into a single octave. The 3rd in this tuning are slightly unstable, but the 4th and 5th are beautiful and suitable for some leads.
MEAN-TONE	This scale was created as an improvement on the Pythagorean scale, by making the major third interval more “in tune.” It was especially popular from the 16th century to the 18th century. Handel, among others, used this scale.
WERCKMEISTER, KIRNBERGER	This composite scale combines the Werckmeister and Kirnberger systems, which were themselves improvements on the mean-tone and Pythagorean scales. The main feature of this scale is that each key has its own unique character. The scale was used extensively during the time of Bach and Beethoven, and even now it is often used when performing period music on the harpsichord.
ARABIC1, ARABIC2	Use these tunings when playing Arabic music.

3 Change the following settings as necessary.

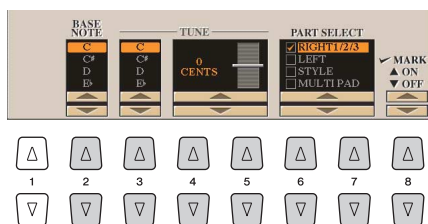

NOTE

To register the Scale Tune settings to Registration Memory, be sure to checkmark the SCALE item in the REGISTRATION MEMORY CONTENTS display.

[2 ▲▼]	BASE NOTE	Determines the base note for each scale. When the base note is changed, the pitch of the keyboard is transposed, yet maintains the original pitch relationship between the notes.
[3 ▲▼]- [5 ▲▼]	TUNE	Select the desired note to be tuned by using the [3 ▲▼] buttons and tune it in cents by using the [4 ▲▼]/[5 ▲▼] buttons. NOTE In musical terms a "cent" is 1/100th of a semitone. (100 cents equal one semitone.)
[6 ▲▼]/ [7 ▲▼]	PART SELECT	Select the part to which the Scale Tune setting is applied by using the [6 ▲▼]/[7 ▲▼] buttons. Then press the [8 ▲] button to add a checkmark or press the [8 ▼] button to remove the checkmark.
[8 ▲▼]	MARK ON/OFF	

Changing the Part Assignment of the TRANSPOSE Buttons

You can determine to which parts the TRANSPOSE [-]/[+] buttons are applied.

1 Call up the operation display.

[FUNCTION] → [D] CONTROLLER → TAB [◀][▶] KEYBOARD/PANEL

2 Use the [B] button to select "4 TRANSPOSE ASSIGN."

3 Press the [4 ▲▼]/[5 ▲▼] buttons to select the desired part assignment.

KEYBOARD	The TRANSPOSE [-]/[+] buttons affect the pitch of keyboard played Voices, Style playback (controlled by the performance in the chord section of the keyboard), and Multi Pad playback (when Chord Match is on, and left-hand chords are indicated)—but they do not affect Song playback.
SONG	The TRANSPOSE [-]/[+] buttons affect only the pitch of Song playback.
MASTER	The TRANSPOSE [-]/[+] buttons affect the overall pitch of the instrument, except audio playback.

The assignment can be confirmed by the pop-up window called up via the TRANSPOSE [-]/[+] buttons.



Editing Voices (Voice Set)

The Voice Set function allows you to create your own Voices by editing some parameters of the existing Voices. Once you've created a Voice, you can save it as a file to internal memory (User drive) or external devices for future recall.

1 Select the desired Voice (other than an Organ World Voice/Ensemble Voice).

Organ World Voices/Ensemble Voices have different editing methods than described here. For instructions on editing the Organ World Voices, see [page 17](#). For instructions on editing the Ensemble Voices, see [page 19](#).

2 Press the [5 ▼] (VOICE SET) button to call up the VOICE SET display.

3 Use the TAB [◀][▶] buttons to call up the relevant setting page.

For information on the available parameters in each page, see the “Editable Parameters in the VOICE SET Displays” on [page 13](#).

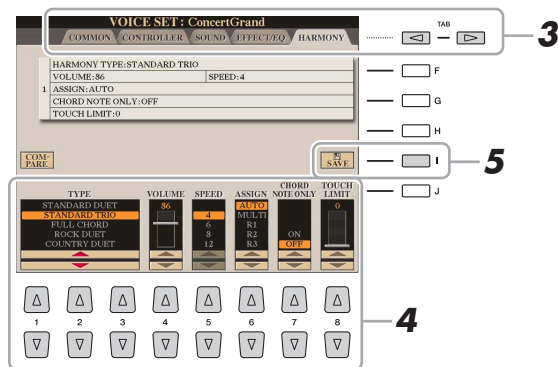

4 As necessary, use the [A]/[B] buttons to select the item (parameter) to be edited and edit the Voice by using the [1 ▲▼]–[8 ▲▼] buttons or sliders.

By pressing the [D] (COMPARE) button, you can compare the sound of the edited Voice with the original (unedited) Voice.

5 Press the [I] (SAVE) button to save your edited Voice.

For details on the Save operation, refer to the Owner's Manual, Basic Operations.

NOTICE

The settings will be lost if you select another Voice or turn the power to the instrument off without executing the Save operation.

Editable Parameters in the VOICE SET Displays

The Voice Set parameters are organized into five different pages. The parameters in each page are described separately, below.



The available parameters differ depending on the Voice.

COMMON Page

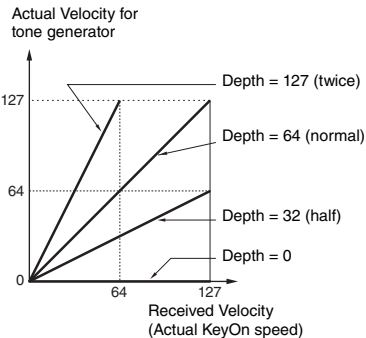
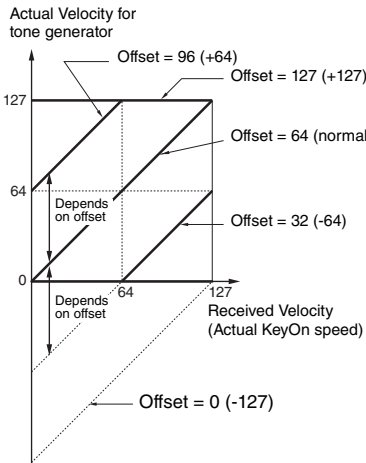
[1 ▲▼]	VOLUME	Adjusts the volume of the current edited Voice.
[2 ▲▼]/ [3 ▲▼]	TOUCH SENSE	<p>Adjusts the touch sensitivity (velocity sensitivity), or how greatly the volume responds to your playing strength.</p> <p>TOUCH SENSE DEPTH Changes to velocity curve according to VelDepth (with Offset set to 64)</p>  <p>TOUCH SENSE OFFSET Changes to velocity curve according to VelOffset (with Depth set to 64)</p>  <p>DEPTH: Determines the velocity sensitivity, or how much the level of the Voice changes in response to your playing strength (velocity).</p> <p>OFFSET: Determines the amount by which received velocities are adjusted for the actual velocity effect.</p>
[4 ▲▼]/ [5 ▲▼]	PART OCTAVE	Shifts the octave range of the edited Voice up or down in octaves. When the edited Voice is used as any of the RIGHT 1–3 parts, the R1/R2/R3 parameter is available; when the edited Voice is used as the LEFT part, the LEFT parameter is available.
[6 ▲▼]	MONO/POLY	Determines whether the edited Voice is played monophonically or polyphonically. This setting can also be made from the VOICE EFFECT [MONO] button on the panel.
[7 ▲▼]	PORTAMENTO TIME	<p>Determines the pitch transition time when the edited Voice is set to MONO above.</p> <p>NOTE Portamento is a function that creates a smooth transition in pitch from the first note played on the keyboard to the next.</p>

CONTROLLER Page

1 MODULATION

The MODULATION wheel can be used to modulate the parameters below as well as the pitch (vibrato). Here, you can set the degree to which the MODULATION wheel modulates each of the following parameters.

[2 ▲▼]	FILTER	Determines the degree to which the MODULATION wheel modulates the Filter Cut-off Frequency. For details about the filter, see below.
[3 ▲▼]	AMPLITUDE	Determines the degree to which the MODULATION wheel modulates the amplitude (volume).
[5 ▲▼]	LFO PMOD	Determines the degree to which the MODULATION wheel modulates the pitch, or the vibrato effect.
[6 ▲▼]	LFO FMOD	Determines the degree to which the MODULATION wheel modulates the Filter modulation, or the wah effect.
[7 ▲▼]	LFO AMOD	Determines the degree to which the MODULATION wheel modulates the amplitude, or the tremolo effect.

2 AFTER TOUCH

After Touch can be used to modulate the parameters below. Here, you can set the degree to which After Touch modulates each of the following parameters.

[2 ▲▼]	FILTER	Determines the degree to which After Touch modulates the Filter Cutoff Frequency. See below for details about Filter.
[3 ▲▼]	AMPLITUDE	Determines the degree to which After Touch modulates the amplitude (volume).
[5 ▲▼]	LFO PMOD	Determines the degree to which After Touch modulates the pitch, or the vibrato effect.
[6 ▲▼]	LFO FMOD	Determines the degree to which After Touch modulates the Filter modulation, or the wah effect.
[7 ▲▼]	LFO AMOD	Determines the degree to which After Touch modulates the amplitude, or the tremolo effect.

■ SOUND Page

FILTER

Filter is a processor that changes the timbre or tone of a sound by either blocking or passing a specific frequency range. The parameters below determine the overall timbre of the sound by boosting or cutting a certain frequency range. In addition to making the sound either brighter or mellower, Filter can be used to produce electronic, synthesizer-like effects.

[1 ▲▼]	BRIGHT (Brightness)	Determines the cutoff frequency or effective frequency range of the filter (see diagram). Higher values result in a brighter sound.	
[2 ▲▼]	HARMO. (Harmonic Content)	Determines the emphasis given to the cutoff frequency (resonance), set in BRIGHT. above (see diagram). Higher values result in a more pronounced effect.	

EG

The EG (Envelope Generator) settings determine how the level of the sound changes in time. This lets you reproduce many sound characteristics of natural acoustic instruments—such as the quick attack and decay of percussion sounds, or the long release of a sustained piano tone.

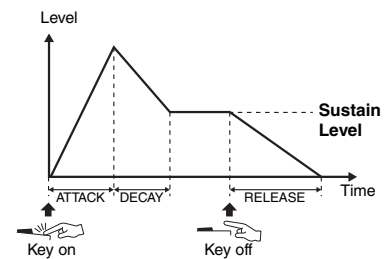

[3 ▲▼]	ATTACK	Determines how quickly the sound reaches its maximum level after the key is played. The lower the value, the quicker the attack.
[4 ▲▼]	DECAY	Determines how quickly the sound reaches its sustain level (a slightly lower level than maximum). The lower the value, the quicker the decay.
[5 ▲▼]	RELES. (Release)	Determines how quickly the sound decays to silence after the key is released. The lower the value, the quicker the decay.

VIBRATO

Vibrato is a quavering, vibrating sound effect that is produced by regularly modulating the pitch of the Voice.

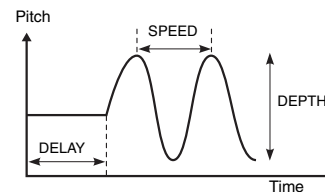

[6 ▲▼]	DEPTH	Determines the intensity of the Vibrato effect. Higher settings result in a more pronounced Vibrato.
[7 ▲▼]	SPEED	Determines the speed of the Vibrato effect.
[8 ▲▼]	DELAY	Determines the amount of time that elapses between the playing of a key and the start of the Vibrato effect. Higher settings increase the delay of the Vibrato onset.

■ EFFECT / EQ Page

1 REVERB DEPTH / CHORUS DEPTH / DSP DEPTH / PANEL SUSTAIN

[1 ▲▼]/ [2 ▲▼]	REVERB DEPTH	Adjusts the reverb depth.
[3 ▲▼]/ [4 ▲▼]	CHORUS DEPTH	Adjusts the chorus depth.
[5 ▲▼]	DSP ON/OFF	Determines whether the DSP effect is on or off. This setting can also be made from the VOICE EFFECT [DSP] button on the panel.
[6 ▲▼]	DSP DEPTH	Adjusts the DSP depth. If you want to re-select the DSP type, you can do so in the “2 DSP” menu explained on page 15 .
[7 ▲▼]	PANEL SUSTAIN	Determines the sustain level applied to the edited Voice when the VOICE EFFECT [SUSTAIN] button on the panel is turned on.

2 DSP

[1 ▲▼]- [4 ▲▼]	DSP TYPE	Selects the DSP effect category and type. Select a type after selecting a category.
[5 ▲▼]- [8 ▲▼]	VARIATION	Two variations are provided for each DSP type. Here, you can edit the VARIATION on/off status and the variation’s parameter value setting.
[5 ▲▼]	ON/OFF	Turns the DSP Variation on or off for the selected Voice. This setting can also be made from the VOICE EFFECT [VARIATION] button on the panel. (This button is effective only when the [DSP] button is on.)
	PARAMETER	Displays the variation parameter. (This differs depending on the effect type and cannot be changed.)
[6 ▲▼]- [8 ▲▼]	VALUE	Adjusts the value of the DSP variation parameter.

3 EQ

Determines the Frequency and Gain of the Low and High EQ bands. For information about EQ, refer to [page 122](#).

■ HARMONY Page

Same as in the [FUNCTION] → [F] HARMONY/ECHO display. See “Using Keyboard Harmony/Echo” on [page 8](#).

Disabling Automatic Selection of Voice Sets (Effects, etc.)

Each Voice is linked to its default VOICE SET parameter settings. Usually these settings are automatically called up when a Voice is selected. However, you can also disable this feature by the operation in the relevant display as explained below. For example, if you want to change the Voice yet keep the same Harmony effect used with the previous Voice, set the HARMONY/ECHO parameter to OFF (in the display explained below).

1 Call up the operation display.

[FUNCTION] → [E] REGIST SEQUENCE/FREEZE/VOICE SET → TAB [◀][▶] VOICE SET

2 Use the [A]/[B] buttons to select the desired keyboard part.

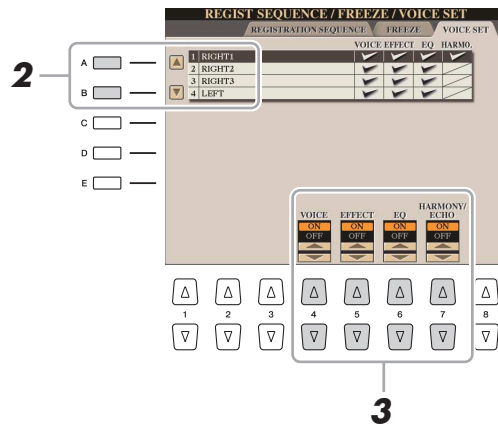

3 Use the [4 ▲▼]–[7 ▲▼] buttons to turn on or off of each item for the selected Part.

When the button is set to ON, the corresponding parameter settings are called up automatically together with the Voice selection. For information on which parameters are linked to each item, see below.

[4 ▲▼]	VOICE	Corresponds to the parameter settings of the COMMON, CONTROLLER, and SOUND pages.
[5 ▲▼]	EFFECT	Corresponds to the parameter settings of 1 and 2 in the EFFECT/EQ page.
[6 ▲▼]	EQ	Corresponds to the parameter settings of 3 in the EFFECT/EQ page.
[7 ▲▼]	HARMONY/ ECHO	Corresponds to the HARMONY page.

Editing Organ Voices (Organ World)

The Organ World Voices can be edited by adjusting the footage levers, adding the attack sound, applying effects and equalizer, etc. If you want, you can also change the Rotary Speaker speed and adjust the Vibrato setting.

1 Select the desired Organ Voice in the Organ World display.

1-1 Press the [ORGAN WORLD] button.

1-2 Use the TAB [◀][▶] buttons to select the organ type which you want to edit.

If you selected the CONCERT or THEATRE type, go on to step 3. Only effect/EQ parameters can be edited for those types.

1-3 Press the [D]/[I] button several times until the Preset Select display is called up.

1-4 Use [1 ▲▼]–[8 ▲▼] buttons to select the desired preset.

2 Press the [D]/[I] button several times to call up the relevant setting display (FOOTAGES or VOLUME&ATTACK)

For information on the available parameters in each display, see [pages 17 and 18](#).

3 Use the [A] (EFFECT) buttons to call up the effect/EQ setting display.

For information on the available parameters in each display, see [pages 15 and 18](#).

4 As necessary, use the [A]/[B] buttons to select the item (parameter) to be edited and edit the Voice by using the [1 ▲▼]–[8 ▲▼] buttons or sliders.

5 Play the keyboard.

■ FOOTAGES Page



[A]	EFFECT	Opens the effect/EQ setting display (page 18).
[C]	ROTARY (Rotary Speaker Speed)/ TREMOLO (Vintage/Home type only)	Alternately switches between the slow and fast rotary speaker speeds when a rotary speaker effect is selected for the Organ Flutes (DSP TYPE parameter in the effect/EQ setting display), and the VOICE EFFECT [DSP] button is turned on.
[F]	VIBRATO (Vintage/Home type only)	Alternately turns the vibrato effect for the Organ Flutes Voice ON or OFF.

NOTICE

After editing, go to the Registration Memory function and save the setting. The settings will be lost if you select another Voice or turn the power of the instrument off without executing the Save operation. For details on the operation, refer to the Owner's Manual.

NOTE

The available parameters differ depending on the Organ type.

[G]/[H]	VIBRATO DEPTH (Vintage/Home type only)	Sets the Vibrato depth to one of three levels: 1 (low), 2 (mid), or 3 (high).
[D]/[I]	FOOTAGES/ VOLUME & ATTACK / PRESETS	Opens the Preset Select display or the relevant setting display (FOOTAGES or VOLUME & ATTACK)

■ VOLUME&ATTACK

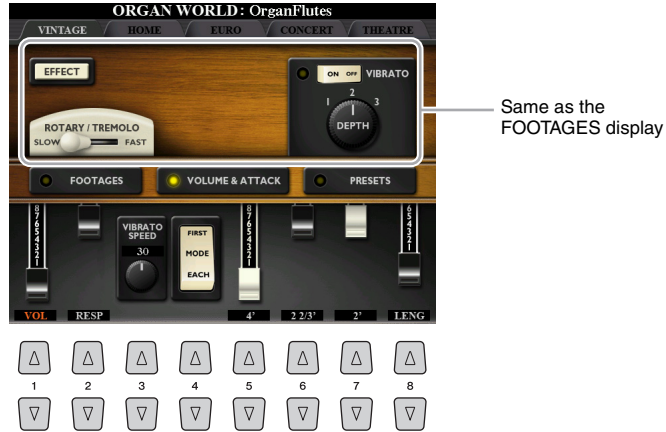

[1 ▲▼]	VOL (Volume)	Adjusts the overall volume of the Organ Flutes. The longer the graphic bar, the greater the volume.
[2 ▲▼]	RESP (Response)	Affects both the attack and release (page 14) portion of the sound, increasing or decreasing the response time of the initial swell and release, based on the FOOTAGES controls. The higher the value, the slower the swell and release.
[3 ▲▼]	VIBRATO SPEED (Vibrato Speed) (Vintage/Home type only)	Determines the speed of the vibrato effect controlled by the Vibrato On/Off ([F] button) and Vibrato Depth ([G]/[H] buttons).
[4 ▲▼]	MODE	The MODE control selects between two modes: FIRST and EACH. In the FIRST mode, attack (percussive sound) is applied only to the first notes played and held simultaneously; while the first notes are held, any subsequently played notes have no attack applied. In the EACH mode, attack is applied equally to all notes.
[5 ▲▼]– [7 ▲▼]	4', 2 2/3', 2'	These determine the attack sound volume of the Organ Flutes Voice. The 4', 2-2/3' and 2' controls increase or reduce the volume of attack sound at the corresponding footages. The longer the graphic bar, the greater the attack sound volume.
[8 ▲▼]	LENG (Length)	Affects the attack portion of the sound producing a longer or shorter decay immediately after the initial attack. The longer the graphic bar, the longer the decay.

■ Effect/EQ related display

Same parameters as in the VOICE SET “EFFECT/EQ” Page explained on page 15.

Editing Ensemble Voices (Ensemble Voice Edit)

In addition to enjoying the Presets, you can create your original Ensemble Voice by editing various parameters as described here. These relevant parameters determine which note is played by each Part, which Preset Voice is used with each Part, when sounds are actually produced, and how the pitch envelope is produced. These settings result in a highly realistic ensemble sound, as if acoustic instruments were played by real artists.

1 Select the desired Ensemble Voice.

1-1 Press the [ENSEMBLE] button.

1-2 Press one of the [1 ▲▼]–[8 ▲▼] buttons to select the Ensemble Voice which you want to edit.

If necessary, press the [J] (PRESETS) button, then select the desired one from the various Preset Ensemble Voices.

For information on how to select more Ensemble Voices, refer to the Owner's Manual.

2 Press the [E] (EDIT) button to call up the Ensemble Voice (edit) display.

3 Use the TAB [◀][▶] buttons to call up the relevant setting page.

For information on the available parameters in each page, see [pages 20–24](#).

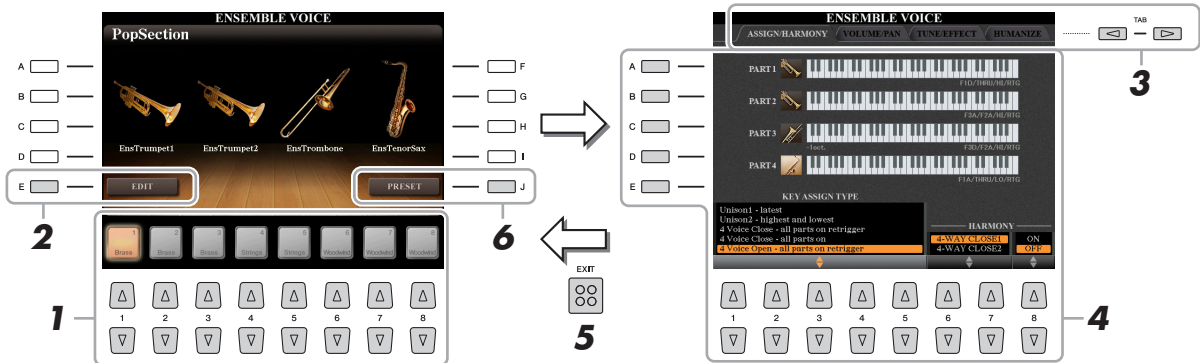

4 Use the [A]–[E] buttons to select a parameter, then use the [1 ▲▼]–[8 ▲▼] buttons or sliders to set the value for each part.

5 Press the [EXIT] button to exit from the edit display.

6 Press the [J] (PRESET) button to save your edited Voice.

For details on the Save operation, refer to the Owner's Manual, Basic Operations.

NOTICE

The edited data will be lost if you change to another Voice or you turn the power off without executing the Save operation.

■ ASSIGN / HARMONY

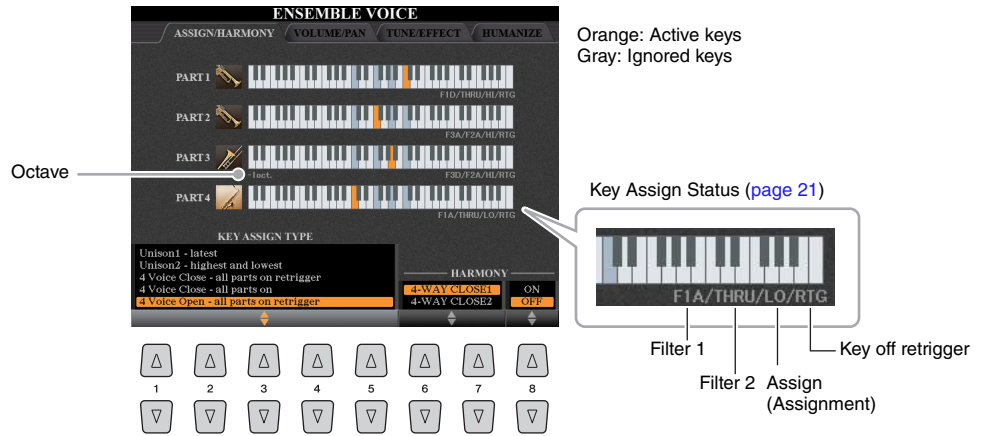



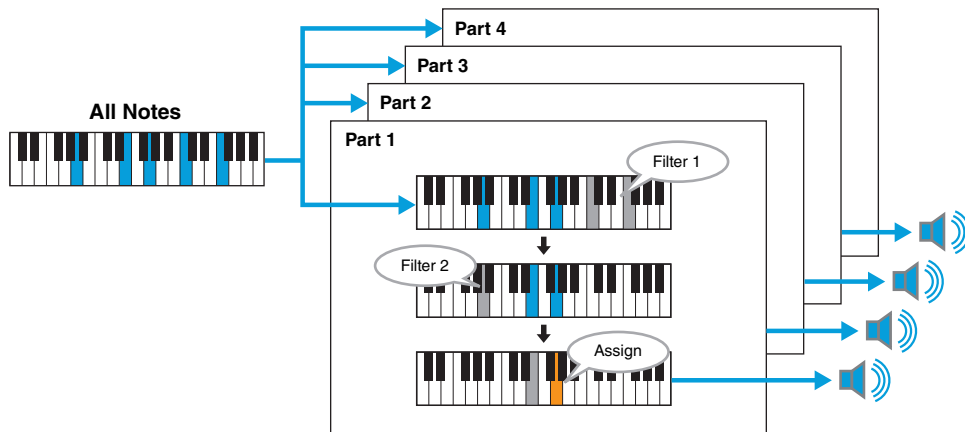

[1 ▲▼]- [5 ▲▼]	KEY ASSIGN TYPE	Determines the Key Assignment type. This is applied commonly to all Voice parts. For details, refer to the Ensemble Voice Key Assign Type List below.
[6 ▲▼]- [7 ▲▼]	HARMONY (Harmony Type)	Same as in the [FUNCTION] → [F] HARMONY/ECHO display. See “Using Keyboard Harmony/Echo” on page 8. Only two types (“4-WAY CLOSE 1” and “4-WAY CLOSE 2”) are available.
[8 ▲▼]	ON/OFF	Turns the Harmony effect on or off.

Ensemble Voice Key Assignment Structure

Each Part monitors all the pressed notes and plays the appropriate notes according to the settings you made. For details about the settings, refer to the Ensemble Voice Key Assign Status List. You can conveniently call up the settings for all parts at once. The current setting of each Part (Key Assignment Status) is displayed at the bottom of its own keyboard figure (see above) on the screen.



Ensemble Voice Key Assign Status List (Indication only)

Parameter	On-screen display	Full name	Description
Filter 1/ Filter 2	F*D	First * in Descending	The highest * notes (“*” indicates the number of notes) are selected from the input notes and sent to the next stage. 
	A*D	After *-th in Descending	The *th highest note and any higher notes do not sound, but all lower notes are selected from the input notes and sent to the next stage. 
	F*A	First * in Ascending	The lowest * notes are selected from the input notes and sent to the next stage. 
	A*A	After *-th in Ascending	The *th lowest note and any lower notes do not sound, but all higher notes are selected from the input notes and sent to the next stage. 
	THRU	Through	All input notes are sent as is to the next stage.
Assign	HI	Highest	Of the notes remaining after Filter 2, the highest is selected.
	LO	Lowest	Of the notes remaining after Filter 2, the lowest is selected.
	EA	Earliest	Of the notes remaining after Filter 2, the one input first of all is selected.
	LA	Latest	Of the notes remaining after Filter 2, the one input last of all is selected.
Key off retrigger	RTG	Retrigger	Key Assign is updated whenever some of the keys are released (and notes satisfying all applicable conditions are played).
	(Not displayed)	-	Whenever keys are released, the corresponding voices simply stop playing and are not reassigned. However, when you play in legato, notes will be retriggered regardless of whether Key off retrigger is off or on (Yes or No in the table below).

* Indicates an integer of 1 or higher.

Ensemble Voice Key Assign Type List

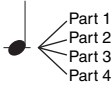
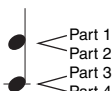
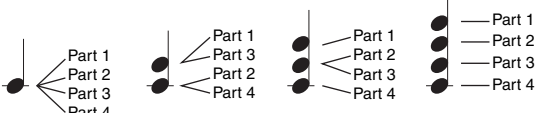
No.	Key Assign Type	Description	Key off retrigger (*3)
1	Unison 1—latest	This setting results in complete unison. If one key is played, all four parts will produce the same note. If multiple keys are played, the unison note will be selected based on the last one played. 	Yes
2	Unison 2—highest and lowest	This setting produces unison or a two-note harmony. If one key is played, all four parts will produce the same note; however, if two or more are played, the parts will be split between the lowest and highest. 	Yes
3	4 Voice Close—all parts on retrigger	This setting is suitable for closed chords. If one key is played, all four parts will produce a sound. If two or more keys are played, the parts will be divided among the various notes of the chord. 	Yes
4	4 Voice Close—all parts on		No

5	4 Voice Open—all parts on retrigger	This setting is suitable for open chords. If one key is played, all four parts will produce a sound. If two or more keys are played, the parts will be divided among the various notes of the chord.	Yes
6	4 Voice Open—all parts on		No
7	4 Voice Incremental 1—from highest retrigger	The more keys played, the greater the number of parts that produce a sound, with priority given to higher parts. For example, Part 1 is played for one key, Part 1 and Part 2 are played for two keys, and so on.	Yes
8	4 Voice Incremental 1—from highest		No
9	4 Voice Incremental 2—from lowest retrigger	The more keys played, the greater the number of parts that produce a sound, with priority given to lower parts. For example, Part 4 is played for one key, Part 4 and Part 3 are played for two keys, and so on.	Yes
10	4 Voice Incremental 2—from lowest		No
11	3 Voice Close—all parts on retrigger	This setting produces a three-note ensemble for closed chords. (*1)	Yes
12	3 Voice Close—all parts on		No
13	3 Voice Open—all parts on retrigger	This setting produces a three-note ensemble for open chords. (*1)	Yes
14	3 Voice Open—all parts on		No
15	3 Voice Incremental 1—from highest retrigger	Three-note version of an ensemble with priority given to higher parts. For example, Parts 1 & 4 are played for one key, Parts 1 & 4 and Part 2 are played for two keys, and so on. (*1)	Yes
16	3 Voice Incremental 1—from highest		No
17	3 Voice Incremental 2—from lowest retrigger	Three-note version of an ensemble with priority given to lower parts. For example, Part 3 is played for one key, Part 3 and Part 2 are played for two keys, and so on. (*1)	Yes
18	3 Voice Incremental 2—from lowest		No
19	2 Voice Close—all parts on retrigger	This setting produces a two-note ensemble for closed chords. (*2)	Yes
20	2 Voice Close—all parts on		No
21	2 Voice Incremental 1—from highest retrigger	Two-note version of an ensemble with priority given to higher parts. For example, Parts 1 & 3 are played for one key, and Parts 1 & 3 and Parts 2 & 4 are played for two keys. (*2)	Yes
22	2 Voice Incremental 1—from highest		No
23	2 Voice Incremental 2—from lowest retrigger	Two-note version of an ensemble with priority given to lower parts. For example, Parts 2 & 4 are played for one key, and Parts 1 & 3 and Parts 2 & 4 are played for two keys. (*2)	Yes
24	2 Voice Incremental 2—from lowest		No

*1: In three-voice ensembles, Part 4 moves in the same way as Part 1.

*2: In two-voice ensembles, Part 3 moves in the same way as Part 1; Part 4 moves in the same way as Part 2.

*3: With ensemble types that support key off retriggering, whenever a part stops playing because the corresponding key is released, it will be reassigned based on the keys still held down and will play the appropriate note.

■ VOLUME / PAN

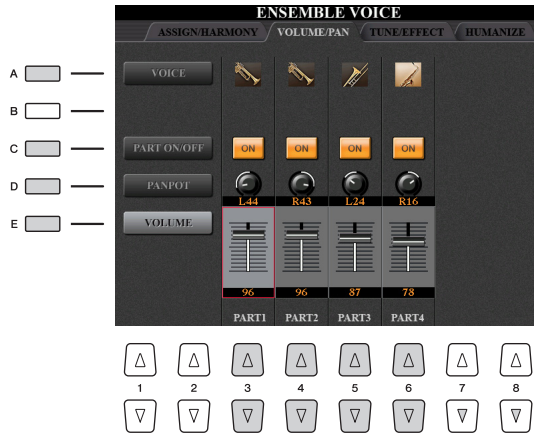

[A]	VOICE	Allows you to re-select the Voices for each part. You can also select this by using the PART SELECT buttons. The PART 1–4 settings correspond to the PART SELECT [LEFT], [PART 1-3] buttons. NOTE Only the recommended Voices that are suitable for Ensemble Voices can be selected.
[C]	PART ON/OFF	Turns each part on or off. The PART 1–4 settings correspond to the PART ON/OFF [LEFT], [PART 1-3] buttons.
[D]	PANPOT	Determines the stereo position of the selected part.
[E]	VOLUME	Determines the volume of each part or channel, giving you fine control over the balance of all the parts. These parameters correspond to the LEFT and RIGHT 1–3 parameters of the VOL/VOICE tab in the MIXING CONSOLE display.
[3 ▲▼]- [6 ▲▼]		Selects the part to which the editing is applied, then set the value for each part.

■ TUNE / EFFECT

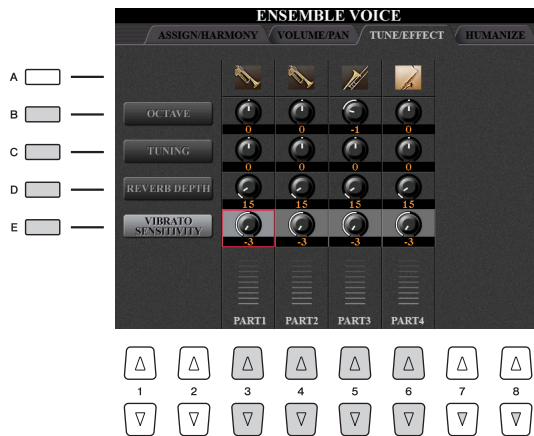

[B]	OCTAVE	Determines the range of the pitch change in octaves, over two octaves up or down for each keyboard part. The value set here is added to the setting made via the OCTAVE [-]/[+] buttons.
[C]	TUNING	Determines the pitch of each keyboard part in cents. NOTE In musical terms, a “cent” is 1/100th of a semitone. (100 cents equal one semitone.)
[D]	REVERB DEPTH	Adjusts the reverb depth.

[E]	VIBRATO SENSITIVITY	Determines the intensity of the Vibrato effect. Higher settings result in a more pronounced Vibrato.
[3 ▲▼]- [6 ▲▼]		Selects the part to which the editing is applied, then set the value for each part.

■ HUMANIZE

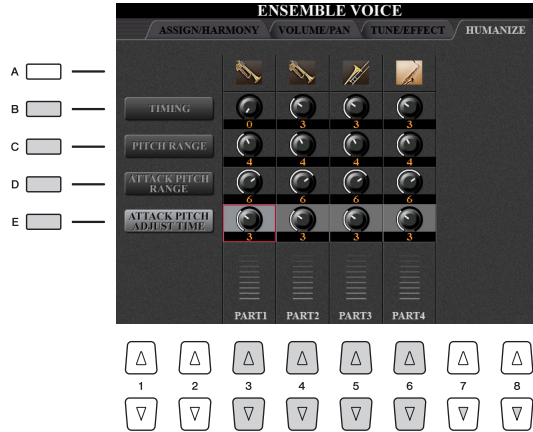

[B]	TIMING	Determines the delay time between the moment the actual sound for each Part is produced and the moment a few notes are pressed.
[C]	PITCH RANGE	Determines the pitch vibration (pitch range) when the sound is being produced. The higher the value, the greater the pitch range.
[D]	ATTACK PITCH RANGE	Determines the actual pitch envelope immediately after the sound is produced. The higher the value, the greater the pitch range.
[E]	ATTACK PITCH ADJUST TIME	Determines the time between the moment the sound is produced and the moment the pitch envelope reaches the correct value.
[3 ▲▼]- [6 ▲▼]		Selects the part to which the editing is applied, then set the value for each part.

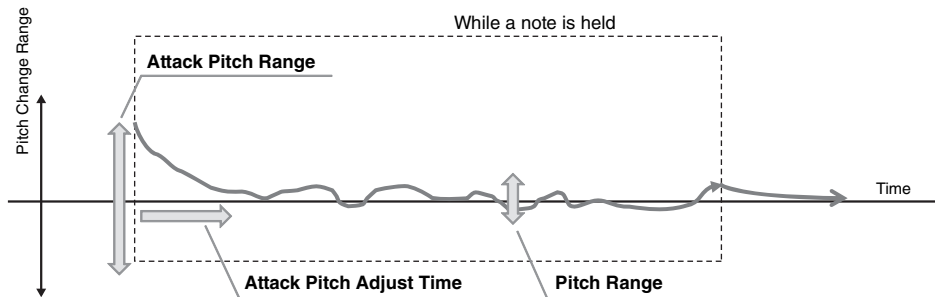

Contents

Selecting the Chord Fingering Type	26
Style Playback Related Settings	28
Memorizing Original Settings to a One Touch Setting.....	30
Creating/Editing Styles (Style Creator)	31
• Realtime Recording	33
• Step Recording	37
• Style Assembly.....	37
• Editing the Rhythmic Feel (GROOVE).....	39
• Editing Data for Each Channel (CHANNEL)	41
• Making Style File Format Settings (PARAMETER)	42

Style Types (Characteristics)

The particular type of Style is indicated at the upper left of the Style name in the Style Selection display. The defining characteristics of these Styles and their performance advantages are described below.



- **Pro:** These Styles provide professional and exciting arrangements combined with perfect playability. The resulting accompaniment exactly follows the chords of the player. As a result, your chord changes and colorful harmonies are instantly transformed into lifelike musical accompaniment.
- **Session:** These Styles provide even greater realism and authentic backing by mixing in original chord types and changes, as well as special riffs with chord changes, with the Main sections. These have been programmed to add “spice” and a professional touch to your performances of certain songs and in certain genres. Keep in mind, however, that the Styles may not necessarily be appropriate—or even harmonically correct—for all songs and for all chord playing. In some cases for example, playing a simple major triad for a country song may result in a “jazzy” seventh chord, or playing an on-bass chord may result in inappropriate or unexpected accompaniment.
- **Free Play:** These Styles are characterized by rubato performance. You can perform freely with remarkably expressive accompaniment, without being constrained by a strict tempo.
- **+Audio:** Indicates the Audio Style. For more information on Audio Styles, refer to the Owner’s Manual.

For the Preset Style List, refer to the Data List downloadable from Yamaha Manual Library.

Selecting the Chord Fingering Type

The Chord Fingering type determines how chords are specified for Style playback. You can select desired one from the seven types.

1 Call up the operation display.

[FUNCTION] → [C] STYLE SETTING/SPLIT POINT/CHORD FINGERING → TAB [◀][▶] CHORD FINGERING

2 Press the [1 ▲▼]–[3 ▲▼] buttons to select a fingering.

For information on each fingering type, see [page 27](#).

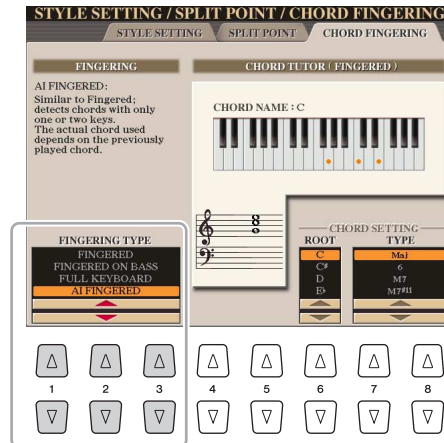

Chord Tutor Function





With this function shown in the right half of this display, you can see which notes to press for specifying the chord. If you know a chord name but don't know how to play it, use this function. Although this function shows how to play a chord only in case of "Fingered," the indication is useful also when a type other than "Single Finger" is selected.

Use the [6 ▲▼] buttons to select the chord root then use the [7 ▲▼]–[8 ▲▼] buttons to select the chord type. The notes you need to play are shown in the display.

NOTE

Depending on the chord, some notes may be omitted.

Chord Fingering Types

<p>SINGLE FINGER</p>	<p>Makes it simple to produce orchestrated accompaniment using major, seventh, minor and minor-seventh chords by pressing only one, two or three keys on the Chord section of the keyboard.</p> <div style="display: flex; justify-content: space-around;"> <div style="text-align: center;"> <p>C</p>  <p>For a major chord, press the root key only.</p> </div> <div style="text-align: center;"> <p>C7</p>  <p>For a seventh chord, simultaneously press the root key and a white key to its left.</p> </div> </div> <div style="display: flex; justify-content: space-around; margin-top: 10px;"> <div style="text-align: center;"> <p>Cm</p>  <p>For a minor chord, simultaneously press the root key and a black key to its left.</p> </div> <div style="text-align: center;"> <p>Cm7</p>  <p>For a minor-seventh chord, simultaneously press the root key and both a white and black key to its left.</p> </div> </div>
<p>MULTI FINGER</p>	<p>Automatically detects Single Finger or Fingered chord fingerings, so you can use either type of fingering without having to switch fingering types.</p>
<p>FINGERED</p>	<p>Lets you specify the chord by pressing the notes making up a chord in the left hand section of the keyboard when ACMP is turned on or the Left part is turned on. For information on which notes to press for each chord, refer to the Data List (Chord Types Recognized in the Fingered Mode) downloadable from Yamaha Manual Library, or use the Chord Tutor function on the right-half of this display.</p>
<p>FINGERED ON BASS</p>	<p>Accepts the same fingerings as Fingered; however, the lowest note played in the Chord section of the keyboard is used as the bass note, allowing you to play “on bass” chords. (In the Fingered type, the root of the chord is always used as the bass note.)</p>
<p>FULL KEYBOARD</p>	<p>Detects chords in the entire key range. Chords are detected in a way similar to Fingered, even if you split the notes between your left and right hands—for example, playing a bass note with your left hand and a chord with your right, or by playing a chord with your left hand and a melody note with your right.</p>
<p>AI FINGERED</p>	<p>Basically the same as Fingered, with the exception that less than three notes can be played to indicate the chords (based on the previously played chord, etc.).</p>
<p>AI FULL KEYBOARD</p>	<p>This type is similar to Full Keyboard, with the exception that less than three notes can be played to indicate the chords (based on the previously played chord, etc.). 9th, 11th and 13th chords cannot be played.</p>
<p>FINGERED*</p>	<p>This type is called up automatically when the CHORD DETECTION AREA is set to “UPPER.” In this status, the whole right-hand (UPPER) section works as the Chord section as well as melody performance. As to which key should be pressed, this is basically same as “FINGERED,” except that “1+5,” “1+8” and Chord Cancel are not available. For more information, refer to “Specifying Chords with Your Right Hand while Playing Bass with Your Left Hand” in the Owner’s Manual.</p>

 **NOTE**

“AI” stands for “Artificial Intelligence.”

Style Playback Related Settings

The instrument has a variety of settings for Style playback which can be accessed in the display below.

1 Call up the operation display.

[FUNCTION] → [C] STYLE SETTING/SPLIT POINT/CHORD FINGERING → TAB [◀][▶] STYLE SETTING

2 Use the [1 ▲▼]–[8 ▲▼] buttons for each setting.

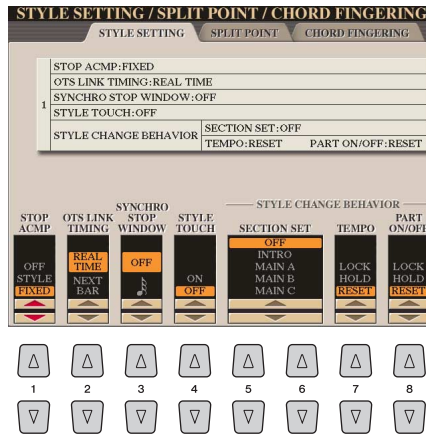

[1 ▲▼]	STOP ACMP	<p>When [ACMP] is turned on and [SYNC START] is off, you can play chords in the chord section of the keyboard with the Style stopped, and still hear the accompaniment chord. In this condition—called “Stop Accompaniment”—any valid chord fingerings are recognized and the chord root/type are shown in the display. Here, you can determine whether the chord played in the chord section will sound or not in the Stop Accompaniment status.</p> <p>OFF: The chord played in the chord section will not sound.</p> <p>STYLE: The chord played in the chord section will sound via the Voices for the Pad part and the Bass channel of the selected Style.</p> <p>FIXED: The chord played in the chord section will sound via the specified Voice, regardless of the selected Style.</p> <p>NOTE When the selected Style contains MegaVoices, unexpected sounds may result when this is set to “STYLE.”</p> <p>NOTE When you record a Song, the chord detected by playing the Stop Accompaniment can be recorded regardless of the setting here. Please note that both the sounding Voice and chord data is recorded when set to “STYLE,” and only the chord data is recorded when set to “OFF” or “FIXED.”</p>
[2 ▲▼]	OTS LINK TIMING	<p>This applies to the OTS Link function. This parameter determines the timing in which the One Touch Settings change with the MAIN VARIATION [A]–[D] change. (The [OTS LINK] button must be on.)</p> <p>REAL TIME: One Touch Setting is immediately called up when you press a MAIN VARIATION button.</p> <p>NEXT BAR: One Touch Setting is called up at the next measure, after you press a MAIN VARIATION button.</p>
[3 ▲▼]	SYNCHRO STOP WINDOW	<p>This determines how long you can hold a chord before the Synchro Stop function is automatically cancelled. When the [SYNC STOP] button is turned on and this is set to a value other than “OFF,” this automatically cancels the Synchro Stop function if you hold a chord for longer than the time set here. This conveniently resets Style playback control to normal, letting you release the keys and still have the Style play. In other words, if you release the keys sooner than the time set here, the Synchro Stop function works.</p>

[4 ▲▼]	STYLE TOUCH	Turns touch response for the Style playback on/off. When this is set to “ON,” the Style volume changes in response to your playing strength in the chord section of the keyboard.
[5 ▲▼]/ [6 ▲▼]	SECTION SET	Determines the default section that is automatically called up when selecting different Styles (when Style playback is stopped). When set to “OFF” and Style playback is stopped, the active section is maintained even if the different Style is selected. When any of the MAIN A–D sections is not included in the Style data, the nearest section is automatically selected. For example, when MAIN D is not contained in the selected Style, MAIN C will be called up.
[7 ▲▼]	TEMPO	<p>This determines whether the tempo setting of the Style changes or not when you change Styles.</p> <p>LOCK: The previous tempo setting is always maintained.</p> <p>HOLD: During Style playback, the previous tempo setting is maintained. When Style playback is stopped, the tempo changes to that of the initial default tempo for the selected Style.</p> <p>RESET: The tempo always changes to that of the initial default tempo for the selected Style.</p>
[8 ▲▼]	PART ON/OFF	<p>This determines whether the Style Channel On/Off status changes or not when you change Styles.</p> <p>LOCK: The Channel On/Off status of the previous Style is always maintained.</p> <p>HOLD: During Style playback, the Channel On/Off status of the previous Style is maintained. When Style playback is stopped, all Style Channels are set to On.</p> <p>RESET: All Style Channels are set to On.</p>

Memorizing Original Settings to a One Touch Setting

You can memorize your original panel settings to a One Touch Setting (OTS). The newly created One Touch Setting will be saved in the User drive as a Style, and you can call up the One Touch Setting as a part of the Style.

- 1 Select the desired Style to memorize your One Touch Setting.**
- 2 Make the desired panel settings, such as those for Voices and effects.**
- 3 Press the [MEMORY] button in the REGISTRATION MEMORY section.**

The REGISTRATION MEMORY CONTENTS display appears. However, you do not need to set these items, since the On/Off settings in this display do not affect the One Touch Settings.

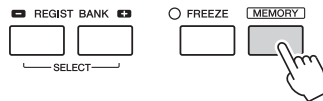

- 4 Press the ONE TOUCH SETTING [1]–[4] button to which you wish to memorize your panel settings.**

Follow the onscreen message. To memorize various panel settings to other buttons, press the [G] (NO) button, then repeat steps 2–4.

NOTE

For OTS buttons to which your original panel settings have not been memorized, the OTS settings of the original Style will be maintained.

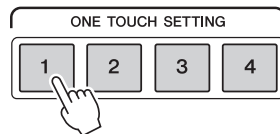

- 5 Press the [F] (YES) button to call up the Style Selection display and save the One Touch Setting as a Style.**

For instructions on saving, refer to the Owner's Manual, Basic Operations.

NOTICE

The memorized One Touch Settings will be lost if you change the Style or turn the power off without executing the Save operation.

Creating/Editing Styles (Style Creator)

The Style Creator function lets you create your original Style by recording the rhythm pattern via the keyboard and using already-recorded Style data. Basically, select a preset Style that is closest to the type you want to create, then record the rhythm pattern, bass line, chord backing, or phrase (referred to as “Source Pattern” in the Style Creator) for each channel of each Section.

■ Style Data Structure—Consisting of Source Patterns

A Style is made up of the different Sections (Intro, Main, Ending, etc.) and each Section has eight separate channels, each of which is referred to as “Source Pattern.” With the Style Creator feature, you can create a Style by separately recording the Source Pattern for each channel, or by importing pattern data from other existing Styles.

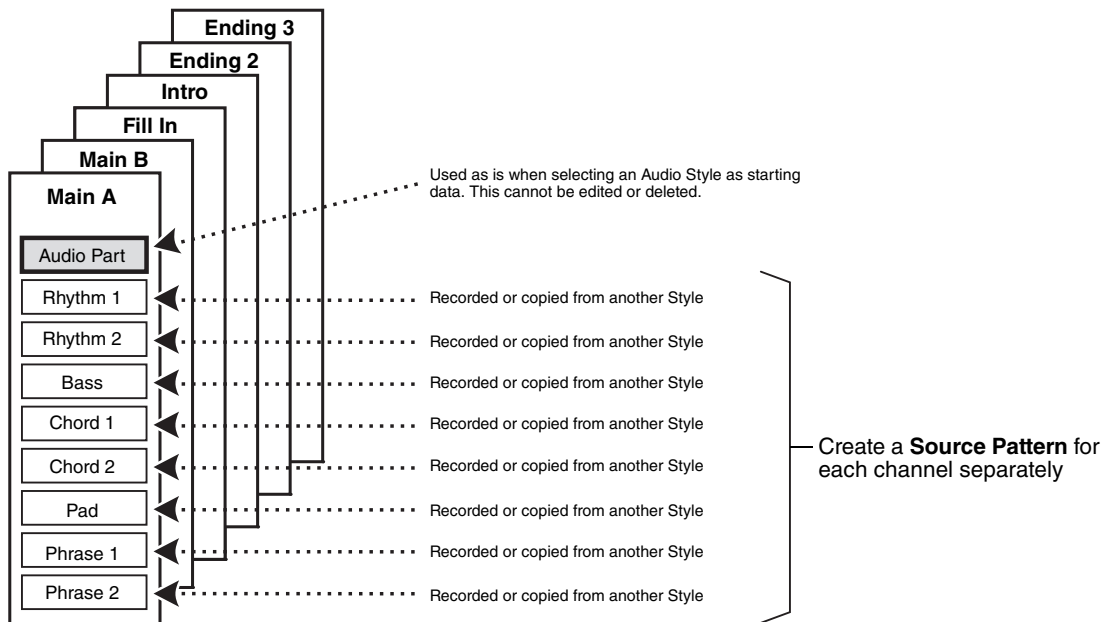

Limitations on the Audio part:

- If you select a preset Audio Style as starting data, the Audio part will be used as is. The Audio part cannot be deleted, edited or created from scratch.
- The created Style containing the Audio part can be used only via an instrument that supports Audio Styles as well as the SFF GE format.
- The Audio part cannot be copied from another Style or Section in the ASSEMBLE page. If you want to use a specific Audio part, make sure to select the corresponding Audio Style before calling up the Style Creator display.

■ Basic Procedure for creating a Style

- 1** Select the desired Style for the starting data.
- 2** Press the [CREATOR] button, then the [B] (STYLE CREATOR) button to call up the Style Creator display.
- 3** From the BASIC page, select a Section, then make other settings as necessary.
 - Select a Section to be edited or recorded. If the REC CHANNEL indication is shown in the lower half section of the display, press the [EXIT] button, press the [A] to select “1 SECTION,” then use the [3 ▲▼]–[4 ▲▼] buttons to select a Section.
 - If you want to create a Style entirely from scratch, press the [C] (NEW STYLE) button to call up an empty new Style.
 - For the current Section, select the pattern length via the [5 ▲▼]–[6 ▲▼] buttons. After selecting, press the [D] (EXECUTE) button to actually enter the specified length.
Note that if an Audio Style is selected as starting data, changing the pattern length deletes the corresponding Audio part.
 - For the entire current Style, set the Tempo and Time Signature in the display called up via the [B] button.

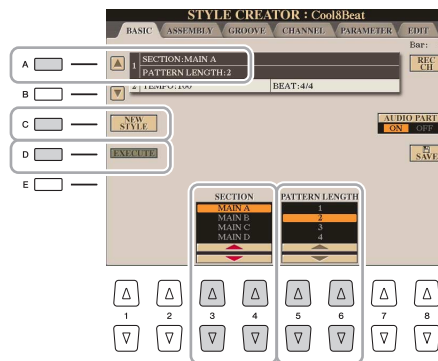

4 Create the Source Pattern for each channel.

- **Realtime Recording on the BASIC page (page 33)**
Lets you record the Style by simply playing the keyboard.
- **Step Recording on the EDIT page (page 37)**
Lets you enter each note individually.
- **Style Assembly on the ASSEMBLY page (page 37)**
Lets you copy various patterns from other preset Styles or Styles you have already created.

5 Edit the already recorded channel data.

- **Editing the channel data on the GROOVE (page 39), CHANNEL (page 41), and EDIT (page 37) pages**
Lets you change the rhythmic feel, quantizing and velocity, etc.
- **Editing the SFF parameters on the PARAMETER page (page 42)**
Lets you copy various patterns from another preset Styles or Styles you have already created.

6 Repeat steps 3–5 as desired.

7 Press the [I] (SAVE) button to save the created Style.

For details, refer to “Basic Operations” in the Owner’s Manual.

Realtime Recording

In the BASIC page, you can record your original rhythm pattern from the keyboard.

Realtime Recording Characteristics in the Style Creator

• Loop Recording

Style playback repeats the rhythm patterns of several measures in a “loop,” and Style recording is also done using loops. For example, if you start recording with a two-measure MAIN section, the two measures are repeatedly recorded. Notes that you record will play back from the next repetition (loop), letting you record while hearing previously recorded material.

• Overdub Recording

This lets you record new material to a channel already containing recorded data, without deleting the original data. In Style recording, the recorded data is not deleted, except when using functions such as Rhythm Clear (page 34) and Delete (page 35). For example, if you start recording with a two-measure MAIN section, the two measures are repeated many times. Notes that you record will play back from the next repetition, letting you overdub new material to the loop while hearing previously recorded material. When creating a Style based on an existing internal Style, overdub recording is applied only to the rhythm channels. For all other channels (except rhythm), you need to delete the original data before recording.

■ Recording Rhythm Channels 1–2

The procedure below applies to Step 4 in the Basic Procedure on page 32.

• If you select an Audio Style as starting data:

Playback of the Audio part can be turned on or off via the [H] button, but it cannot be edited or deleted. Note that the rhythm pattern of this part will be used in the new Style you intend to create. If you want to create a rhythm phrase in addition to the Audio part, follow the steps below.

1 From the BASIC page, while holding down the [F] (REC CH) button, press the [1 ▼] or [2 ▼] button to select the desired channel as Record target.

A Rhythm channel can be selected as Record target no matter whether already recorded data is included or not. If already recorded data is included in the selected channel, you can record notes additionally to the existing data.



2 If necessary, select a Voice then practice the rhythm pattern to be recorded.

Press the [1 ▲] or [2 ▲] button (selected channel) to call up the Voice Selection display then select the desired Voice such as Drum Kit. After selecting, press the [EXIT] button to return to the original display. With the selected Voice, practice the rhythm pattern to be recorded.

• Available Voices for recording

For the RHY1 channel, any except the Organ World Voices can be used for recording.

For the RHY2 channel, only drum/SFX kits can be used for recording.

3 Press the STYLE CONTROL [START/STOP] button to start recording.

As the already recorded data plays back, use the [1 ▼]–[8 ▼] buttons to turn each channel on or off as desired. If you selected an Audio Style as starting data, turn the Audio part on or off via the [H] button.

4 As soon as loop playback returns to the first beat in the first measure, start playing the rhythm pattern to be recorded.

If the rhythm is difficult to play in real time, break it up into individual parts and play each separately as the playback loops, as shown in the example below.

The diagram illustrates three rounds of a drum loop, each shown in a separate box with a downward arrow between them. Each round consists of two measures of music on a five-line staff.

- Loop 1st round:** Labeled "Loop 1st round". The staff is labeled "Bass Drum". It shows a rhythmic pattern of quarter notes with stems pointing down, alternating between the first and second lines of the staff.
- Loop 2nd round:** Labeled "Loop 2nd round". The staff is labeled "Snare Drum" and "Bass Drum". The Snare Drum part consists of eighth notes with stems pointing up, grouped in pairs. The Bass Drum part is identical to the first round.
- Loop 3rd round:** Labeled "Loop 3rd round". The staff is labeled "Hi-Hat", "Snare Drum", and "Bass Drum". The Hi-Hat part consists of eighth notes with stems pointing up, grouped in pairs. The Snare Drum part consists of quarter notes with stems pointing up. The Bass Drum part is identical to the first round.

If you make a mistake or play any wrong notes:

You can delete notes of a specific drum instrument. While holding down the [E] (RHY CLEAR) button, press the corresponding key on the keyboard.

5 Press the [START/STOP] button to stop playback.

If you want to add more notes, press the [START/STOP] button again to continue recording.

6 Press the [1 ▼] or [2 ▼] button to disengage Record.

■ Recording Bass, Chord 1–2, Pad and Phrase 1–2

The procedure below applies to Step 4 in the Basic Procedure on [page 32](#).

1 From the BASIC page, while holding down the [F] (REC CH) button, press one of the [3 ▼]–[8 ▼] buttons to select the desired channel as Record target.

A confirmation message appears, prompting you whether or not to delete the already recorded data of the selected channel. Press the [G] (YES) button to delete data and the selected channel is specified as the Record target. Note that channel data of the preset Style cannot be overdubbed.



2 If necessary, select a Voice then practice the bass line, chord backing, or phrase to be recorded.

Press one of the [3 ▲]–[8 ▲] buttons (selected channel) to call up the Voice Selection display then select the desired Voice. After selecting, press the [EXIT] button to return to the original display. With the selected Voice, practice the phrase or chord backing to be recorded.

• Available Voices for recording

Any except for the Organ World Voices/Drum Kit/SFX kit Voices can be used for recording.

• Record a phrase in C Maj7 (for playing appropriate notes while chords change during performance)

Rules when recording a Main or Fill

With the default initial settings, the Source Root/Chord is set to CMaj7. This means that you should record a Source Pattern using a CMaj7 scale, which will change according to the chords you specify during normal performance. Record a bass line, phrase or chord backing which you want to hear when CMaj7 is specified. See below for details.

- Use only the CMaj7 scale tones when recording the BASS and PHRASE channels (i.e., C, D, E, G, A, and B).
- Use only the chord tones when recording the CHORD and PAD channels (i.e., C, E, G, and B).

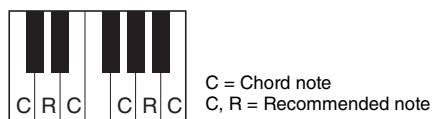

If you observe this rule, Style playback notes are appropriately converted depending on the chord changes you make during your performance.

Rules when recording an Intro or Ending

These Sections are designed assuming that the chord is not changed during playback. This is why you need not observe the rule for Main and Fill-In Sections described above, and you can create special chord progressions when recording. However, follow the rules below since the Source Root/Chord is set to CMaj7.

- When recording the Intro, make sure that the recorded phrase leads properly into the CMaj7 scale.
- When recording the Ending, make sure that the recorded phrase begins with or properly follows a CMaj7 scale.

- **Setting the Source Root/Chord if necessary**

Although the Source Root/Chord is set to CMaj7 as described above, you can change this to any desired key or chord. Use the TAB [◀][▶] buttons to call up the PARAMETER page, and set the SOURCE ROOT and CHORD to the desired Root and Chord type. Keep in mind that when you change the Source Chord from the default CMaj7 to another chord, the chord notes and recommended notes will also change. For details, refer to [page 43](#).

3 Press the STYLE CONTROL [START/STOP] button to start recording.

Since already recorded data plays back, use the [1 ▼]–[8 ▼] buttons to turn on or off each channel as desired. If you selected an Audio Style as starting data, turn the Audio part on or off via the [H] button.

4 As soon as loop playback returns to the first beat in the first measure, start playing the bass line, chord backing or phrase to be recorded.

5 Press the [START/STOP] button to stop playback.

If you want to add more notes, press the [START/STOP] button again to continue recording.

- **To hear the playback sound of the already recorded channels with another Source Chord/Root:**

- 1) Use the TAB [◀][▶] buttons to call up the PARAMETER page.
- 2) While holding down the [F] (REC CH) button, press the [1 ▼] or [2 ▼] button to set a Rhythm channel to REC.
- 3) Press the STYLE CONTROL [START/STOP] button to start playback.
- 4) On the PARAMETER page, set the PLAY ROOT and CHORD to the desired Chord root and Chord type.

The above operation lets you hear how the Source Pattern is played back via chord changes during normal performance.

6 Press the [1 ▼] or [2 ▼] button to disengage Record.

Step Recording

This section applies to Step 4 of the Basic Procedure on [page 32](#). After selecting a Section and making other settings on the BASIC page, call up the STEP RECORD display via the instructions below, then execute Step Recording.

- 1) From the BASIC page, while holding down the [F] (REC CH) button, press one of the [1 ▼]–[8 ▼] buttons to select the desired channel as Record target.
- 2) Use the TAB [▶] button to call up the EDIT page.
- 3) If “SYS/EX.” is shown at the position corresponding to the [F] button, press the [F] button to call up the Channel Edit display.
- 4) Press the [G] (STEP REC) button to call up the STEP RECORD display.

The Step Recording procedure in the Style Creator is essentially same as that in Song Creator ([page 59](#)), with the exception of the following points:

- Unlike in Song Creator, the End Mark position cannot be changed in the Style Creator. This is because setting the Pattern Length on the BASIC page determines the End Mark position. For example, if you select a Section of four measures or you set the Pattern Length to “4” on the BASIC page, the End Mark position is automatically set to the end of the fourth measure, and cannot be changed.
- Unlike in Song Creator, a Recording channel can be set on the BASIC page. It cannot be set on the EDIT page.
- Unlike in Song Creator, Chord and Lyrics data cannot be entered. This is because such data is not necessary for Style playback.

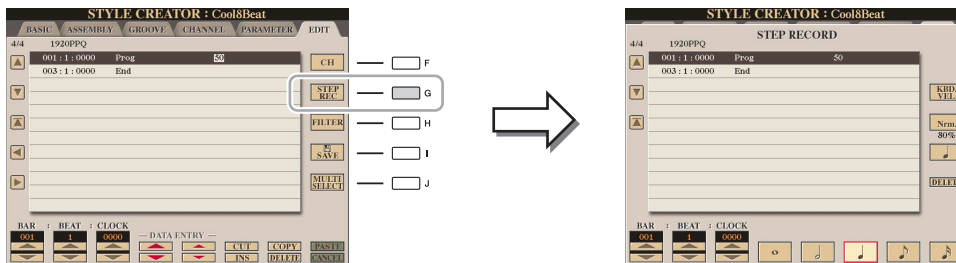

For instructions on Step Recording, refer to [pages 60–63](#). For information on the EDIT page (Event List display in Song Creator), refer to [page 72](#).

Style Assembly

This allows you to copy channel data as a Source Pattern from another preset Style to the currently created Style. Use this function if you find a favorite rhythm pattern, bass line, chord backing or phrase from another Style.

The instructions below apply to Step 4 of the Basic Procedure on [page 32](#). After selecting a Section and making other settings on the BASIC page, execute the instructions below.

1 Call up the operation display.

[CREATOR] → [B] STYLE CREATOR → TAB [◀][▶] ASSEMBLY

2 If necessary, select the Section to be edited.

Even if the Section to be edited has already been selected on the BASIC page, you can change the Section also on this page. Press the desired Section button on the panel to call up the SECTION window, use the [6 ▲▼]–[7 ▲▼] buttons if you want to select a Fill in, then press the [8 ▲] (OK) button to actually enter the selection.

NOTE

An Audio part cannot be copied from another Style.

NOTE

If you select an Audio Style as starting data, the Audio part cannot be replaced with different data.

NOTE

Intro 4 and Ending 4 can be selected on the display then created as part of your original Style although they are not available on the panel.

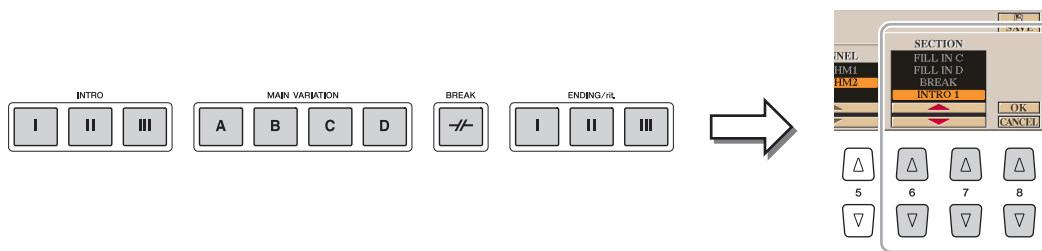

3 Replace the Source Pattern of the specific channel with that of another Style.

- 3-1** Select the desired channel to be replaced via the [A]–[D] and [F]–[I] buttons.
 - 3-2** Press the same button of the selected channel to call up the Style Selection display.
 - 3-3** Select the desired Style, then press the [EXIT] button to return to the original display.
 - 3-4** Select the Section and Channel of the selected Style via the [2 ▲▼]–[5 ▲▼] buttons.
 - 3-5** Confirm the sound with the newly assigned Source Pattern via the [6 ▲▼]–[7 ▲▼] buttons.
- For details, see “Playing the Style During Style Assembly” below.

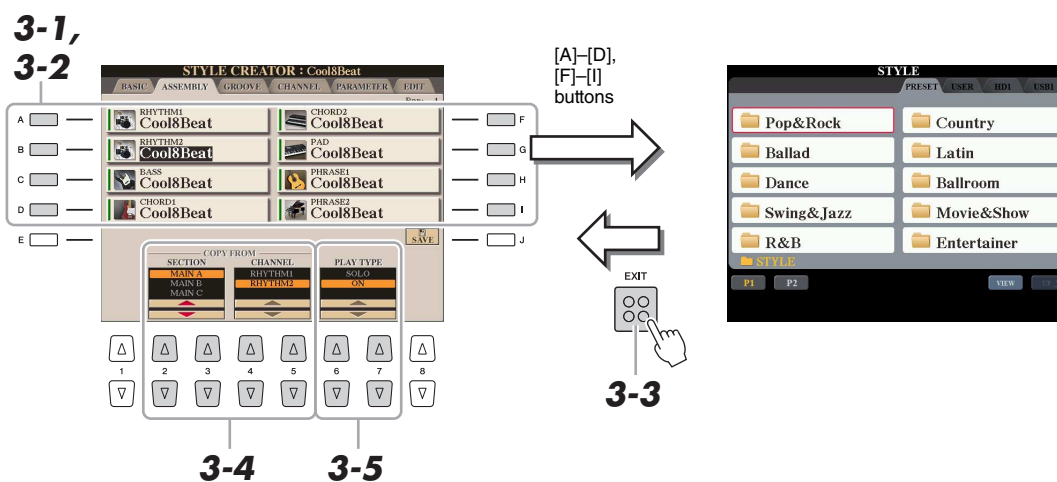

4 As desired, execute the same operations for another channel.

Playing the Style During Style Assembly

While you are assembling a Style, you can play back the Style and select the method of playback. Use the [6 ▲▼]/[7 ▲▼] (PLAY TYPE) buttons in the Style Assembly display to select the playback method.

- **SOLO:** Plays back the selected channel in the ASSEMBLY Page. Any channels set to REC in the REC CHANNEL display on the BASIC Page are played back simultaneously.
- **ON:** Plays back the selected channel in the ASSEMBLY Page. Any channels set to other than OFF in the REC CHANNEL display on the BASIC Page are played back simultaneously.
- **OFF:** Mutes the selected channel in the ASSEMBLY Page.

Editing the Rhythmic Feel (GROOVE)

By changing the timing of all the notes and velocities, you can edit the rhythmic feel for each channel of the current Section selected on the BASIC page or the panel button. The instructions below apply to Step 5 of the Basic Procedure on page 32.

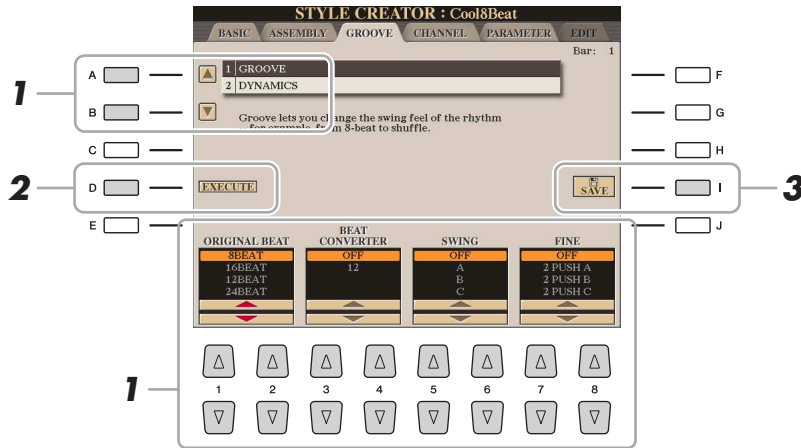

1 In the GROOVE Page, use the [A]/[B] buttons to select the edit menu, then edit the data by using the [1 ▲▼]–[8 ▲▼] buttons.

1 GROOVE

This lets you add swing to the music or change the “feel” of the beat by making subtle shifts in the timing (clock) of the Style. The Groove settings are applied to all channels of the Section selected on the BASIC page.

[1 ▲▼]/ [2 ▲▼]	ORIGINAL BEAT	Specifies the beats to which Groove timing is to be applied. In other words, if “8 Beat” is selected, Groove timing is applied to the 8th notes; if “12 Beat” is selected, Groove timing is applied to 8th-note triplets.
[3 ▲▼]/ [4 ▲▼]	BEAT CONVERTER	Actually changes the timing of the beats (specified in the ORIGINAL BEAT parameter above) to the selected value. For example, when ORIGINAL BEAT is set to “8 Beat” and BEAT CONVERTER is set to “12,” all 8th notes in the section are shifted to 8th-note triplet timing. The “16A” and “16B” Beat Converter which appear when ORIGINAL BEAT is set to “12 Beat” are variations on a basic 16th-note setting.
[5 ▲▼]/ [6 ▲▼]	SWING	Produces a “swing” feel by shifting the timing of the back beats, depending on the ORIGINAL BEAT parameter above. For example, if the specified ORIGINAL BEAT value is “8 Beat,” the Swing parameter will selectively delay the 2nd, 4th, 6th, and 8th beats of each measure to create a swing feel. The settings “A” through “E” produce different degrees of swing, with “A” being the most subtle and “E” being the most pronounced.
[7 ▲▼]/ [8 ▲▼]	FINE	Selects a variety of Groove “templates” to be applied to the selected section. The “PUSH” settings cause certain beats to be played early, while “HEAVY” settings delay the timing of certain beats. The numbered settings (2, 3, 4, 5) determine which beats are to be affected. All beats up to the specified beat—but not including the first beat—will be played early or delayed (for example, the 2nd and 3rd beats, if “3” is selected). In all cases, “A” types produce minimum effect, “B” types produce medium effect, and “C” types produce maximum effect.

2 DYNAMICS

This changes the velocity/volume (or accent) of certain notes in Style playback. The Dynamics settings are applied to each channel or all channels of the Section selected on the BASIC page.

[1 ▲▼]/ [2 ▲▼]	CHANNEL	Selects the desired channel (part) to which Dynamics is to be applied. The selected channel is shown at the upper left of the display.
[3 ▲▼]/ [4 ▲▼]	ACCENT TYPE	Determines the type of accent applied—in other words, which notes in the part(s) are emphasized with the Dynamics settings.
[6 ▲▼]	STRENGTH	Determines how strongly the selected Accent Type (above) will be applied. The higher the value, the stronger the effect.
[7 ▲▼]	EXPAND/COMP.	Expands or compresses the range of velocity values. Values higher than 100% expand the dynamic range, while values lower than 100% compress it.
[8 ▲▼]	BOOST/CUT	Boosts or cuts all velocity values in the selected section/channel. Values above 100% boost the overall velocity, while values below 100% reduce it.

2 Press the [D] (EXECUTE) button to actually enter the edits for each display.

The values which are shown in the STRENGTH, EXPAND/COMP. and BOOST/CUT parameters are expressed as a percentage of the last set value.

After the operation is completed, this button changes to “UNDO,” letting you restore the original data if you are not satisfied with the Groove or Dynamics results. The Undo function only has one level; only the previous operation can be undone.

Editing Data for Each Channel (CHANNEL)

You can edit recorded data for each channel of the current Section selected on the BASIC page or via the panel buttons. The instructions below apply to Step 5 of the Basic Procedure on [page 32](#).

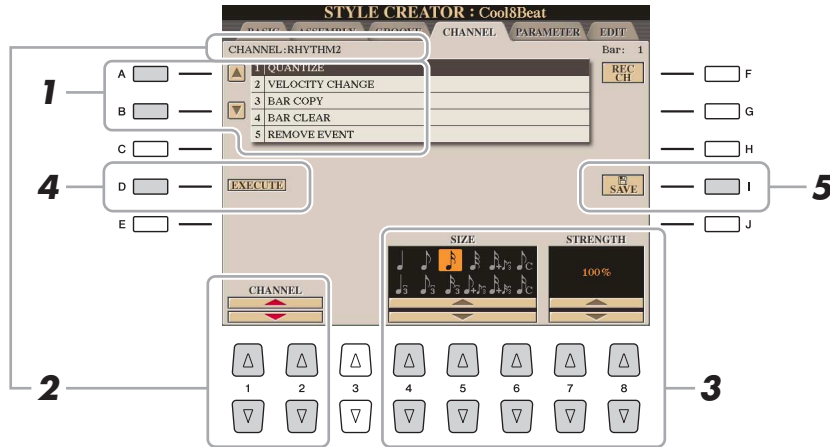

1 In the CHANNEL Page, use the [A]/[B] buttons to select the particular edit operation.

1 QUANTIZE

Same as in the Song Creator ([page 70](#)), with the exception of the two additional available parameters below.

- Eighth notes with swing
- Sixteenth notes with swing

2 VELOCITY CHANGE

Boosts or cuts the velocity of all notes in the specified channel, according to the percentage specified here.

3 BAR COPY

This function allows data to be copied from one measure or group of measures to another location within the specified channel.

[4 ▲▼]	TOP	Specifies the first (TOP) and last (LAST) measures in the region to be copied.
[5 ▲▼]	LAST	
[6 ▲▼]	DEST	Specifies the first measure of the destination location, to which the data is to be copied.

4 BAR CLEAR

This function clears all data from the specified range of measures within the selected channel.

5 REMOVE EVENT

This function lets you remove specific events from the selected channel.

2 Use the [1 ▲▼]/[2 ▲▼] (CHANNEL) buttons to select the channel to be edited.

The selected channel is shown at the upper left of the display.

3 Use the [4 ▲▼]–[8 ▲▼] buttons to edit the data.

4 Press the [D] (EXECUTE) button to actually enter the edits for each display.

After the operation is completed, this button changes to “UNDO,” letting you restore the original data if you are not satisfied with the results of the edit. The Undo function only has one level; only the previous operation can be undone.

5 Press the [I] (SAVE) button to execute the Save operation.

NOTICE

The edited Style will be lost if you change to another Style or turn the power to the instrument off without executing the Save operation.

Making Style File Format Settings (PARAMETER)

The Style File Format (SFF) combines all of Yamaha's auto accompaniment (Style playback) know-how into a single unified format. Setting the SFF related parameters determines how the original notes are converted to the actual sounded notes based on the chord you specify in the Chord area of the keyboard. The conversion flow is shown below.

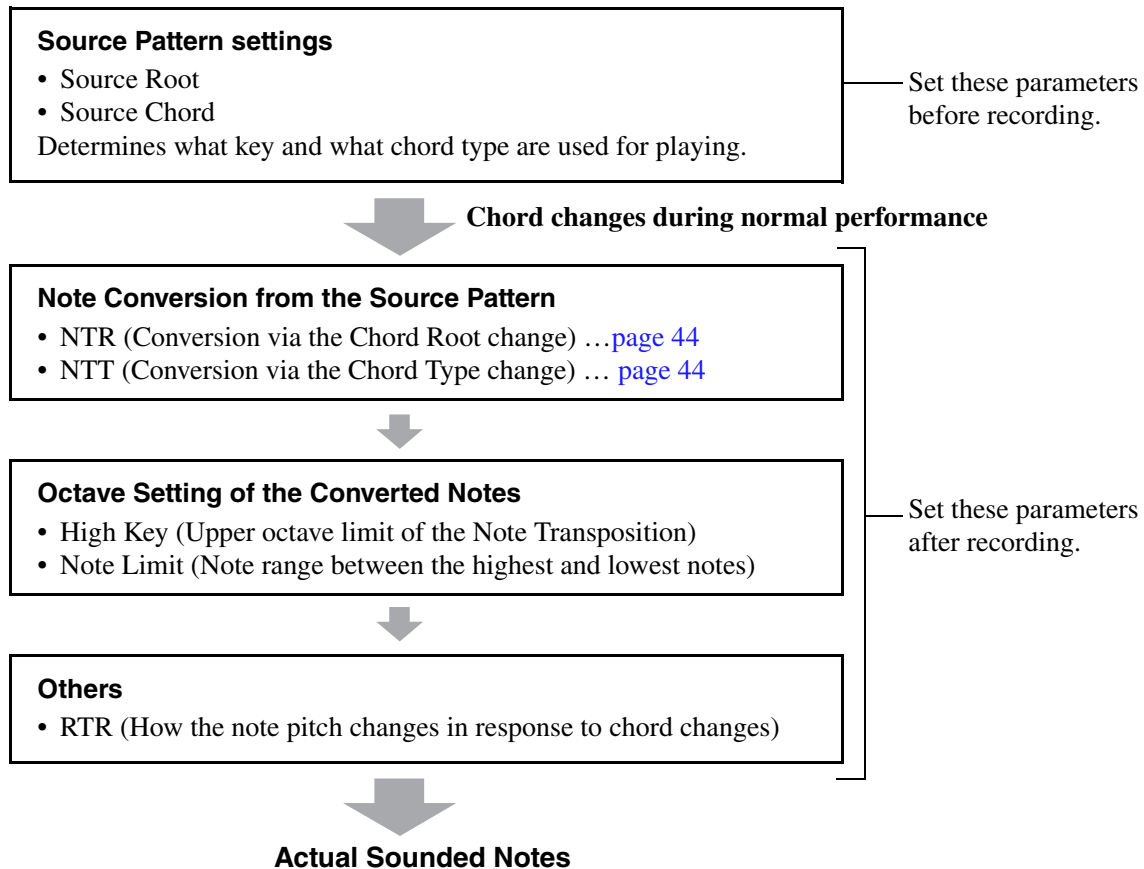

The instructions below apply to Step 5 of the Basic Procedure on [page 32](#).

1 In the PARAMETER Page, use the [A]/[B] buttons to select the particular edit operation.

For details on the edit operations, see [page 43](#).

NOTE

The parameters you can set here are compatible with the SFF GE format. This is why the Style files created on this instrument can be played back only on instruments which are compatible with SFF GE.

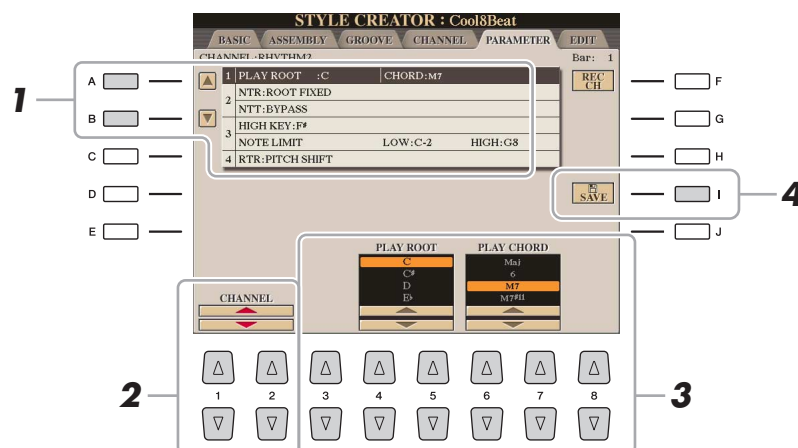

2 Use the [1 ▲▼]/[2 ▲▼] (CHANNEL) buttons to select the channel to be edited.

The selected channel is shown at the upper left of the display.

3 Use the [3 ▲▼]–[8 ▲▼] buttons to edit the data.

For details on editable parameters, see the explanations following Step 4 below.

4 Press the [I] (SAVE) button to execute the Save operation.

NOTICE

The edited Style will be lost if you change to another Style or turn the power to the instrument off without executing the Save operation.

IMPORTANT

The parameters here should be set before recording. If you change the settings after recording, the appropriate note conversion cannot be done even when you specify various chord types.

1 SOURCE (PLAY) ROOT/CHORD

Before recording, you should set these parameters. They determine what key is used for playing when you record the Source Pattern to the Bass, Chord, Pad or Phrase channel. If you set this to “Fm7,” your recorded original phrase (Source Pattern) will be triggered by specifying Fm7 during normal performance. CMaj7 (Source Chord Root = C and Source Chord Type = Maj7) is set by default. Depending on the settings here, the playable notes (chord notes and recommended scale notes) will differ. For details, see below.

When the Source Root is C:

 C R C C R	 C R C C C R	 C R C C R C	 C R C C R C C	 C C C C R	 C C C C R C	 C C C C C R
 C R C R C R	 C R R C C	 C R R C C C	 C G R C C	 C R G R C	 C C R C C	 C C R C C
 C R C C C G	 C R R C C C	 C C R R C C	 C G R C R	 C R R G R C	 C C C C C	 C C C C G
 C R C C C C	 C C C C C C	 C R C C C C	 C R C C C C	 C C C C C C	 C R C R C C	 C C C C R C
 C R C R R C C	 C R C R C C C	 C C C C C	 C C C C C	 C R C C C	 C C R C R	

C = Chord notes
C, R = Recommended notes

NOTE

When Rhy1 or Rhy2 is selected as Record target, the parameter name here is shown as “PLAY ROOT” instead of “CHORD ROOT.” In this situation, you can confirm the actual sound in response to each Chord type by changing the Chord Root and Type.

NOTE

The settings here are not applied when NTR is set to GUITAR.

2 NTR/NTT

The settings here determine how the original notes of the Source Pattern are converted in response to the Chord change during normal performance.

[3 ▲▼]/ [4 ▲▼]	NTR (Note Transposition Rule)	Determines the relative position of the root note in the chord, when converted from the Source Pattern in response to chord changes. Refer to the list below.
[5 ▲▼]- [7 ▲▼]	NTT (Note Transposition Table)	Sets the note transposition table for the source pattern. Refer to the list below.
[8 ▲▼]	NTT BASS ON/ OFF	The channel for which this is set to ON will be played back by the bass root note, when on-bass chords are recognized by the instrument. When NTR is set to GUITAR and this parameter is set to ON, only notes which are assigned to the bass will be played back by the bass root note.

NTR (Note Transposition Rule)

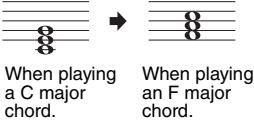
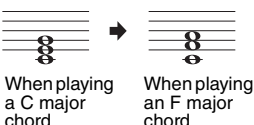
ROOT TRANS (Root Transpose)	When the root note is transposed, the interval between notes is maintained. For example, the notes C3, E3 and G3 in the key of C become F3, A3 and C4 when they are transposed to F. Use this setting for channels that contain melody lines.	
ROOT FIXED	The note is kept as close as possible to the previous note range. For example, the notes C3, E3 and G3 in the key of C become C3, F3 and A3 when they are transposed to F. Use this setting for channels that contain chord parts.	
GUITAR	This is exclusively for transposing guitar accompaniment. Notes are transposed to approximate the chords played with natural guitar fingering.	

NTT (Note Transposition Table)

When NTR is set to ROOT TRANS or ROOT FIXED

BYPASS	When NTR is set to ROOT FIXED, the transposition table used does not do any note conversion. When NTR is set to ROOT TRANS, the table used only converts the notes by maintaining the pitch relationship between notes.
MELODY	Suitable for melody line transposition. Use this for melody channels such as Phrase 1 and Phrase 2.
CHORD	Suitable for chordal parts transposition. Use this for the Chord 1 and Chord 2 channels, especially when they contain piano or guitar-like chordal parts.
MELODIC MINOR	When the played chord changes from a major to a minor chord, this table lowers the third interval in the scale by a semitone. When the chord changes from a minor to a major chord, the minor third interval is raised by a semitone. Other notes are not changed. Use this for melody channels of Sections which respond only to major/minor chords, such as Intros and Endings.
MELODIC MINOR 5th	In addition to the Melodic Minor transposition above, augmented and diminished chords affect the 5th note of the Source Pattern.
HARMONIC MINOR	When the played chord changes from a major to a minor chord, this table lowers the third and sixth intervals in the scale by a semitone. When the chord changes from a minor to a major chord, the minor third and flatted sixth intervals are raised by a semitone. Other notes are not changed. Use this for chord channels of Sections which respond only to major/minor chords, such as Intros and Endings.
HARMONIC MINOR 5th	In addition to the Harmonic Minor transposition above, augmented and diminished chords affect the 5th note of the Source pattern.
NATURAL MINOR	When the played chord changes from a major to a minor chord, this table lowers the third, sixth and seventh intervals in the scale by a semitone. When the chord changes from a minor to a major chord, the minor third, flatted sixth and flatted seventh intervals are raised by a semitone. Other notes are not changed. Use this for chord channels of Sections which respond only to major/minor chords such as in Intros and Endings.

NATURAL MINOR 5th	In addition to the Natural Minor transposition above, augmented and diminished chords affect the 5th note of the Source pattern.
DORIAN	When the played chord changes from a major to a minor chord, this table lowers the third and seventh intervals in the scale by a semitone. When the chord changes from a minor to a major chord, the minor third and flatted seventh intervals are raised by a semitone. Other notes are not changed. Use this for chord channels of Sections which respond only to major/minor chords such as in Intros and Endings.
DORIAN 5th	In addition to the Dorian transposition above, augmented and diminished chords affect the 5th note of the Source pattern.

When NTR is set to GUITAR

ALL-PURPOSE	This table covers both strummed- and arpeggio-played sounds.
STROKE	Suitable for strumming sounds of the guitar. Some notes may sound as if they are muted—this is normal when chords are strummed on an actual guitar.
ARPEGGIO	Suitable for arpeggio-played sound of the guitar, resulting in beautiful four-note arpeggio sounds.

3 HIGH KEY / NOTE LIMIT

The settings here adjust the octave of the notes converted from the original ones through NTT and NTR.

[4 ▲▼]/ [5 ▲▼]	HIGH KEY	<p>This sets the highest key (upper octave limit) of the note transposition for the chord root change. Any notes calculated to be higher than the highest key are transposed down to the next lowest octave. This setting is available only when the NTR parameter (page 44) is set to “Root Trans.”</p> <p>Example—When the highest key is F.</p> <p>Root changes → CM C#M . . . FM F#M . . .</p> <p>Notes played → C3-E3-G3 C#3-E#3-G#3 F3-A3-C4 F#2-A#2-C#3</p>
[6 ▲▼]	NOTE LIMIT LOW	<p>These set the note range (highest and lowest notes) for Voices recorded to the Style channels. By judicious setting of this range, you can ensure that the Voices sound as realistic as possible—in other words, that no notes outside the natural range are sounded (e.g., high bass sounds or low piccolo sounds).</p> <p>Example—When the lowest note is C3 and the highest is D4.</p> <p>Root changes → CM C#M . . . FM . . .</p> <p>Notes played → E3-G3-C4 E#3-G#3-C#4 F3-A3-C4</p>
[7 ▲▼]	NOTE LIMIT HIGH	

4 RTR (Retrigger Rule)

These settings determine whether notes stop sounding or not and how they change pitch in response to chord changes.

STOP	The notes stop sounding.
PITCH SHIFT	The pitch of the note will bend without a new attack to match the type of the new chord.
PITCH SHIFT TO ROOT	The pitch of the note will bend without a new attack to match the root of the new chord.
RETRIGGER	The note is retriggered with a new attack at a new pitch corresponding to the next chord.
RETRIGGER TO ROOT	The note is retriggered with a new attack at the root note of the next chord. However, the octave of the new note remains the same.

3

Multi Pads

– Adding Musical Phrases to Your Performance –

Contents

Multi Pad Creating (Multi Pad Creator).....	46
• Multi Pad—Realtime Recording via MIDI	46
• Multi Pad—Step Recording via MIDI	48
Multi Pad Editing.....	48

Multi Pad Creating (Multi Pad Creator)

This feature lets you create your original Multi Pad phrases, and also allows you to edit existing Multi Pad phrases to create your own. As with Song Creator, Multi Pad Creator features Realtime Recording and Step Recording. However, with Song Creator, each Multi Pad consists of only one channel and convenient functions such as Punch In/Out are not available.

Multi Pad—Realtime Recording via MIDI

Before starting operation, note the following points:

- Since only the Right 1 part performance will be recorded as a Multi Pad phrase, you should select the desired Voice for the Right 1 part beforehand.
- The Super Articulation Voices and the Organ Flutes Voices cannot be used for Multi Pad Recording. If one of these Voices is set for the Right 1 part, it will be replaced with the Grand Piano Voice when recording.
- Since recording can be done along with and synchronized to Style playback, you should select the desired Style beforehand. However, keep in mind that the Style is not recorded.

1 If you want to create a new Multi Pad in the existing Bank, select the desired Multi Pad Bank.

If you want to create a new Multi Pad in an empty new Bank, this step is unnecessary.

2 Call up the operation display.

[CREATOR] → [C] MULTI PAD CREATOR

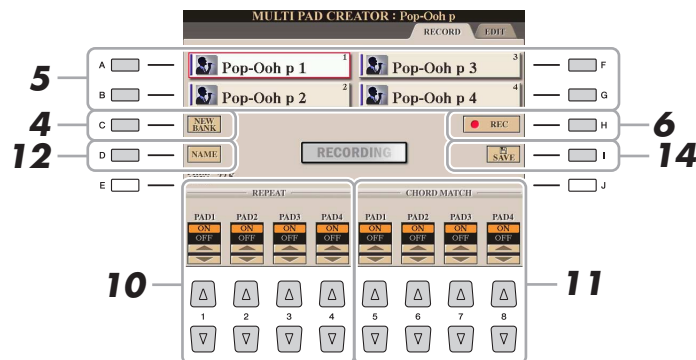

NEXT PAGE

- 3** If necessary, select the desired Voice with the VOICE category selection buttons.
After selecting the Voice, press the [EXIT] button to return to the previous display.
- 4** If you want to create a new Multi Pad in an empty new Bank, press the [C] (NEW BANK) button.
- 5** Select a particular Multi Pad for recording by pressing any of the [A], [B], [F] and [G] buttons.
- 6** Press the [H] (REC) button to enter recording standby status for the Multi Pad selected in step 5.

7 Play the keyboard to start recording.

If you want to insert silence before the actual phrase, press the STYLE CONTROL [START/STOP] to start both the Recording and rhythm playback (of the current Style). Keep in mind that the rhythm part of the current Style plays back during recording although it is not recorded.

Recommended notes for the Chord Match phrase

If you intend to create a Chord Match phrase, use the notes of C, D, E, G, A and B, or in other words, play the phrase in the key of C major. This ensures that the phrase will stay harmonically constant and match whichever chord you play in the left hand section of the keyboard.

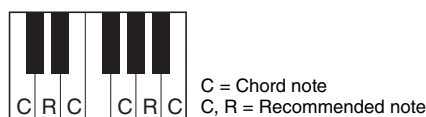

8 Stop recording.

Press the [H] (STOP) button or the panel MULTI PAD CONTROL [STOP] button or the STYLE CONTROL [START/STOP] button to stop recording when you've finished playing the phrase.

9 Listen back to your newly recorded phrase, by pressing the appropriate MULTI PAD button, [1]–[4]. To re-record the phrase, repeat steps 6–8.

10 Turn the Repeat parameter of each pad On or Off by using the [1 ▲▼]–[4 ▲▼] buttons.

If the Repeat parameter is on for the selected pad, playback of the corresponding pad will continue until the MULTI PAD [STOP] button is pressed. When you press a Multi Pad for which Repeat is turned on during Song or Style playback, playback will start and repeat in sync with the beat.

If the Repeat parameter is off for the selected pad, playback will end automatically as soon as the end of the phrase is reached.

11 Turn Chord Match of each pad On or Off by using the [5 ▲▼]–[8 ▲▼] buttons.

If the Chord Match parameter is on for the selected pad, the corresponding pad is played back according to the chord specified in the chord section of the keyboard generated by turning [ACMP] on.

12 Press the [D] (NAME) button, then enter the desired name for each Multi Pad.

13 If you want to record other Multi Pads, repeat steps 5–12.

14 Press the [I] (SAVE) button to save the Multi Pad, then save the Multi Pad data as a Bank containing a set of four Pads.

Multi Pad—Step Recording via MIDI

Step Recording can be executed in the EDIT page. After selecting a Multi Pad in step 5 on [page 47](#), press the TAB [▶] button to select the EDIT page.

The EDIT page indicates the Event list, which lets you record notes with absolutely precise timing. This Step Recording procedure is essentially the same as that for Song Recording ([pages 60–63](#)), with the exception of the points listed below:

- There is no LCD button for switching channels, since Multi Pads contain data for only a single channel.
- In the Multi Pad Creator, only channel events and System Exclusive messages can be entered. Chord and Lyrics events are not available. You can switch between the two types of Event Lists by pressing the [F] button.

Multi Pad Editing

You can manage (rename, copy, paste and delete) your created Multi Pad Bank and each of the Multi Pads belonging to the Bank. For instructions on managing the Multi Pad Bank, refer to the Basic Operations of the Owner’s Manual. This section covers how to manage each Multi Pad.

1 Select the Multi Pad Bank containing the Multi Pad to be edited.

Press the MULTI PAD CONTROL [SELECT] button to call up the Multi Pad Bank Selection display, use the TAB [◀][▶] buttons to call up “PRESET,” “USER” or “USB” (when USB flash memory is connected), then use the [A]–[J] buttons to select the desired Multi Pad Bank.

NOTE

If you select a Preset Multi Pad Bank then edit the Multi Pads, save your edits to “USER” or “USB” (when USB flash memory is connected) as a User Bank.

2 Press the [7 ▼] (EDIT) button of Menu 1 to call up the MULTI PAD EDIT display.

3 Select a particular Multi Pad to be edited by pressing any of the [A], [B], [F] and [G] buttons.

4 Edit the selected Pad.



[1 ▼]	NAME	Changes the name of each Multi Pad.
[3 ▼]	COPY	Copies the Multi Pad(s). See below.
[4 ▼]	PASTE	Pastes the Multi Pad(s) copied by the [3 ▼] button.
[5 ▼]	DELETE	Deletes the selected Multi Pads.

Copying the Multi Pad

- 1** Press the [3 ▼] button of Menu 2 in step 4 above.
- 2** Select the Multi Pad to be copied by using the [A], [B], [F] and [G] buttons, then press the [7 ▼] (OK) button.
The selected Multi Pad is copied to the clipboard.
- 3** Select the destination location by using the [A], [B], [F] and [G] buttons. If you want to copy the selected Pad to another bank, press the [8 ▲] (UP) button to call up the Multi Pad Bank Selection display, select the desired bank, press the [7 ▼] (EDIT) button of Menu 1, then select the destination.
- 4** Press the [4 ▼] (PASTE) button of Menu2 button to execute the Copy operation.

5 Save the current Bank containing the edited Multi Pads.

Press the [8 ▲] button to call up the confirmation window, press the [G] (YES) button to call up the USER page, then press the [6 ▼] (SAVE) button of Menu2 to execute the Save operation. For details, refer to the Basic Operations of the Owner's Manual.

Contents

Editing Music Notation Settings	51
Editing Lyrics/Text Display Settings	53
Using the Auto Accompaniment Features with Song Playback.....	54
Song Playback Related Parameters (Repeat Settings, Channel Settings, Guide Function)	55
• Keyboard and Vocal Practice Using the Guide Function	56
• Playing Backing Parts with the Performance Assistant Technology	58
Creating/Editing Songs (Song Creator)	59
• Recording Melodies (Step Recording)	60
• Recording Chords (Step Recording)	64
• Re-Recording a Specific Section—Punch In/Out (Realtime Recording) ..	67
• Editing Channel Events of Existing Song Data.....	69
• Editing Chord Events, Notes, System Exclusive Events and Lyrics	72
• Editing Song Position Markers.....	75

Restrictions for protected Songs

To prevent illegal copy or accidental erasure, protection is applied depending on the Song. The protection indication is marked at the upper left of the protected Song name on the display.

- **Prot.1:** Indicates that the Preset Song is saved to the User drive. This type of Song cannot be copied, moved and transferred to external devices such as a USB flash memory and a computer.
- **Prot.2 Orig:** Indicates Yamaha-protection-formatted Songs (commercially available Songs). This type of Song (which cannot be copied) can be only moved and saved to the User drive or USB storage device with ID.
- **Prot.2 Edit:** Indicates the edited “Prot.2” Song. This type of Song (which cannot be copied) can be only moved and saved to the User drive or USB storage device with ID.

IMPORTANT

Make sure that the “Prot.2 Orig” Song and the corresponding “Prot.2 Edit” Song reside in the same folder. Otherwise, the “Prot.2 Edit” Song cannot be played back. If you move this type of Song, make sure to move both the “Prot.2 Orig” and “Prot.2 Edit” Songs to the same folder.

IMPORTANT

Never change the “Prot2.Orig” Song name and icon on the display. Otherwise, the corresponding “Prot.2 Edit” Song cannot be played back.

Editing Music Notation Settings

To view the music notation of the selected Song, press the [SCORE] button. You can change the Score display as desired to suit your personal preferences. The settings here are maintained even when the power is turned off.

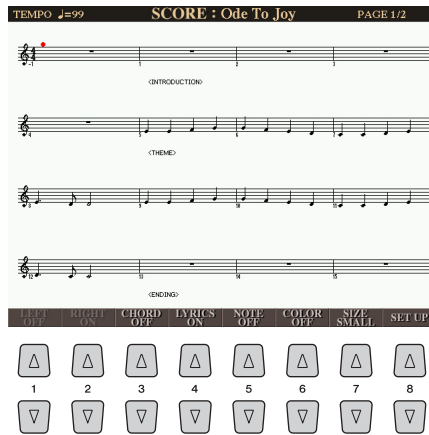

NOTE

You can save the setting here as a part of a Song by accessing [CREATOR] → [A] SONG CREATOR → TAB [◀][▶] CHANNEL → [A]/[B] SETUP. See [page 71](#).

NOTE

Depending on the particular commercially available Song, Score display may not be possible.

NOTE

The score of an Audio Song cannot be shown because the score is created based only on MIDI events.

[1 ▲▼]	LEFT ON/OFF	Enables/disables display of the left-hand notation. Depending on other settings, this parameter may be unavailable and may appear grayed out. If this is the case, go to the detailed setting display (on page 52) and set the LEFT CH parameter to any channel except "AUTO." Or, go to the display [FUNCTION] → [B] SONG SETTING and set the TRACK 2 parameter to any channel except "OFF" (page 55). RIGHT (next parameter) and LEFT cannot be turned off at the same time.
[2 ▲▼]	RIGHT ON/OFF	Enables/disables display of the right-hand notation. RIGHT and LEFT (above) cannot be turned off at the same time.
[3 ▲▼]	CHORD ON/OFF	Enables/disables display of the chords. If the selected Song does not contain chord data, chords are not displayed.
[4 ▲▼]	LYRICS ON/OFF	Enables/disables display of the lyrics. If the selected Song does not contain lyric data, lyrics are not displayed. When the Song contains Pedal events, pressing these buttons can display the Pedal events, instead of displaying Lyrics.
[5 ▲▼]	NOTE ON/OFF	Enables/disables display of the note name (pitch). The note name is indicated at the left of the note. When the space between the notes is too small, the indication may be moved to the top left of the note. When the Song contains Fingering events, pressing these buttons can display the fingering, instead of displaying note names.
[6 ▲▼]	COLOR ON/OFF	When this is set to ON, the notes in the display appear in color (C: red, D: yellow, E: green, F: orange, G: blue, A: purple, and B: gray).
[7 ▲▼]	SIZE	Determines the display zoom level of the notation.
[8 ▲▼]	SET UP	Calls up the detailed setting display. See page 52 .

1 Pressing the [8 ▲▼] (SET UP) button calls up the detailed setting display. You can set the view type by using the [1 ▲▼]–[6 ▲▼] buttons, then press the [8 ▲] (OK) button.

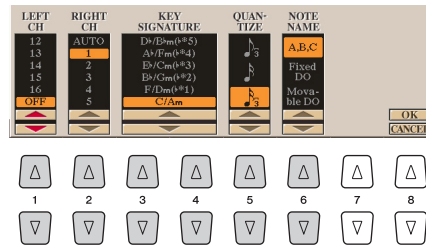

[1 ▲▼]	LEFT CH	Determines which MIDI channel in the Song data is used for the left-hand/right-hand part. This setting returns to AUTO when a different Song is selected.
[2 ▲▼]	RIGHT CH	<p>AUTO: The MIDI channels in the Song data for the right- and left-hand parts are assigned automatically—setting the parts to the same channel as the channel which is specified in [FUNCTION] → [B] SONG SETTING (page 55).</p> <p>1–16: Assigns the specified MIDI channel (1–16) to each of the left- and right-hand parts.</p> <p>OFF (Available setting only for LEFT CH): Assigns no channel to the left-hand part. This disables display of the left-hand key range.</p>
[3 ▲▼]/ [4 ▲▼]	KEY SIGNATURE	This lets you enter key signature changes in the middle of a Song, at the stopped position. This menu is useful when the selected Song contains no key signature settings for displaying notation.
[5 ▲▼]	QUANTIZE	This gives you control over the note resolution in the notation, letting you shift or correct the timing of all displayed notes so that they line up to a particular note value. Make sure to select the smallest note value used in the Song.
[6 ▲▼]	NOTE NAME	<p>Selects the type of the note name indicated at the left of the note in the notation from among the following three types. The settings here are available when the NOTE ON/OFF parameter above is set to ON.</p> <p>A, B, C: Note names are indicated as letters (C, D, E, F, G, A, B).</p> <p>Fixed DO: Note names are indicated in solfeggio, with the note of C fixed to DO. The notes “C, D, E, F, G, A, B” are always indicated as “Do, Re, Mi, Fa, So, La, Ti” when the language is set to English. Note that the note name indication differs depending on the current language (page 56).</p> <p>Movable DO: Note names are indicated in solfeggio according to the key of the current Song. When the Song with the D Major key is selected, for example, the notes “D, E, F#, G, A, B, C#” are indicated as “Do, Re, Mi, Fa, Sol, La, Ti” when the language is set to English. Note that the note name indication differs depending on the current language (page 56).</p>

Editing Lyrics/Text Display Settings

To view the lyrics of the selected Song, press the [LYRICS/TEXT] button. If the selected Song contains lyric data, you can have the lyrics shown in the display. Even if the Song does not contain lyrics data, you can show the lyrics and other text by using a text file (.txt file less than 60KB) created on a computer.

NOTE

When the lyrics are garbled or unreadable, you may need to change the Lyrics Language setting from the [FUNCTION] → [B] SONG SETTING.

NOTE

When you create a text file on a computer, make sure to enter line breaks manually. This is necessary because auto line breaks cannot be executed on this instrument. When you find that the text extends beyond the display and cannot be shown properly, revise the text data by manually entering appropriate line breaks.

Lyrics display

The lyrics in the Song data are shown.



Press the [1 ▲▼] buttons



Text display

The text created on a computer is shown.

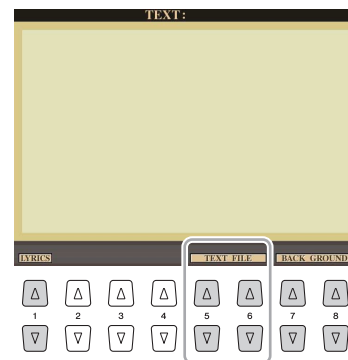

Press the [5 ▲▼]/[6 ▲▼] button to actually call up the desired text file.

[1 ▲▼]	TEXT/LYRICS	Switches the screen between the Lyrics display (lyrics data in the Song is shown) and the Text display (a text file selected via the [5 ▲▼]/[6 ▲▼] buttons).
[5 ▲▼]/ [6 ▲▼]	TEXT FILE	Calls up the text File Selection display. After selecting, press the [EXIT] button to return back to the Lyrics/Text display.
[7 ▲▼]/ [8 ▲▼]	BACK GROUND	Allows changing of the background picture of the Lyrics/Text display. After making the setting, press the [EXIT] button to return back to the Lyrics/Text display. NOTE When the background picture is specified in the Song data, the BACKGROUND setting cannot be changed. NOTE For information on available image files, refer to the MAIN PICTURE parameter on page 130 .

Using the Auto Accompaniment Features with Song Playback

When playing back a Song and a Style at the same time, channels 9-16 in the Song data are replaced with Style channels—allowing you to play the accompaniment parts of the Song yourself. Try playing chords along with the Song playback as shown in the instructions below.

- 1** Select a Song.
- 2** Select a Style.
- 3** While holding down the SONG [■] (STOP) button, press the [▶/||] (PLAY/PAUSE) button to enable synchronized start of the Song.

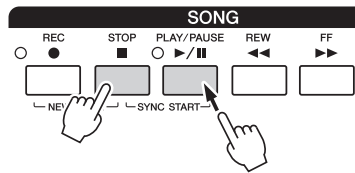

- 4** Press the STYLE CONTROL [ACMP] button to turn on the auto accompaniment function, then press the [SYNC START] button to enable synchronized start of the accompaniment.

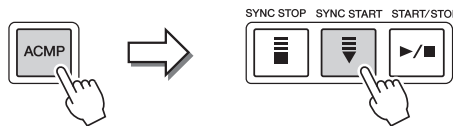

- 5** Press the STYLE CONTROL [START/STOP] button or play chords in the chord section.

The Song and Style starts playing. When you play chords, pressing the [SCORE] button and turning CHORD on (page 51) allows you to see the chord information.

When the Song playback is stopped, Style playback is also stopped at the same time.

NOTE

When playing back a Song and a Style at the same time, the tempo value set in the Song is automatically used.

Song Playback Related Parameters (Repeat Settings, Channel Settings, Guide Function)

The instrument has a variety of Song playback functions—repeat playback, various guide settings, etc.—which can be accessed in the display below.

1 Call up the operation display.

[FUNCTION] → [B] SONG SETTING

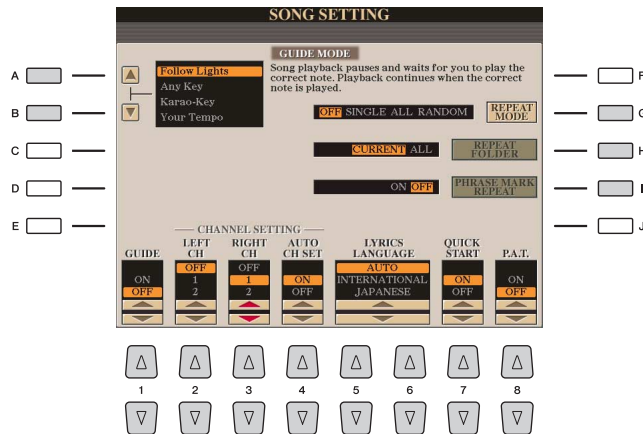

[A]/[B]	GUIDE MODE	See page 56 .
[1 ▲▼]	GUIDE ON/OFF	
[G]	REPEAT MODE	Determines the method of repeat playback. OFF: Plays through the selected Song, then stops. SINGLE: Plays through the selected Song repeatedly. ALL: Continues playback through all the Songs in the specified folder repeatedly. RANDOM: Continues playback at random through all the Songs in the specified folder repeatedly.
[H]	REPEAT FOLDER	Determines the directory in which the contained Songs are played in sequence when REPEAT MODE is set to “ALL” or “RANDOM.” Here, the directory refers to the path memorized to each of the SONG [I]–[IV] buttons. CURRENT: Sequentially plays all Songs in the directory containing the currently selected Song, starting with the currently selected Song. ALL: Sequentially plays all Songs in all directories (memorized to the SONG [I]–[IV] buttons). Playback starts with the currently selected Song, then the remainder of the Songs in the current directory, followed by the Songs in the other directories.
[I]	PHRASE MARK REPEAT	This parameter is available only when the current Song contains Phrase Marks, which specify certain locations (of several measures each) in the Song. When this is set to ON, the section corresponding to the Phrase Mark (specified via the SONG [◀◀] (REW) and [▶▶] (FF) buttons) is played back repeatedly. Note that this parameter can be set only when Song playback is stopped.

[2 ▲▼]	LEFT CH	These parameters determine which MIDI channel in the Song data is assigned to the Left- or Right-hand part of the Guide function and the Song Score function.
[3 ▲▼]	RIGHT CH	
[4 ▲▼]	AUTO CH SET	When set to “ON,” this automatically sets the proper MIDI channels for the Right- and Left hand parts pre-programmed in the commercially available Song data. Normally, this should be set to “ON.”
[5 ▲▼]/ [6 ▲▼]	LYRICS LANGUAGE	Determines the language displayed in the Lyrics display. AUTO: When the language is specified in the Song data, the lyrics are displayed accordingly. When the language is not specified in the Song data, the lyrics language is regarded as INTERNATIONAL below. INTERNATIONAL: Handles the displayed lyrics as a western language. JAPANESE: Handles the displayed lyrics as Japanese.
[7 ▲▼]	QUICK START	On some commercially available Song data, certain settings related to the Song (such as Voice selection, volume, etc.) are recorded to the first measure, before the actual note data. When Quick Start is set to “ON,” the instrument reads all initial non-note data of the Song at the highest possible speed, then automatically slows down to the appropriate tempo at the first note. This allows you to start playback as quickly as possible, with a minimum pause for reading of data.
[8 ▲▼]	P.A.T. (Performance Assistant Technology)	See page 58 .

Keyboard and Vocal Practice Using the Guide Function

With the Guide function, the instrument indicates the timing you need to play notes in the Score display for ease in learning. This instrument also features convenient vocal practice tools that automatically adjust the timing of Song playback to match your vocal performance.

- 1** Select the desired Song for practicing the keyboard or singing.
- 2** Call up the Song Setting display.
[FUNCTION] → [B] SONG SETTING
- 3** Use the [A]/[B] buttons to select the desired Guide function type.

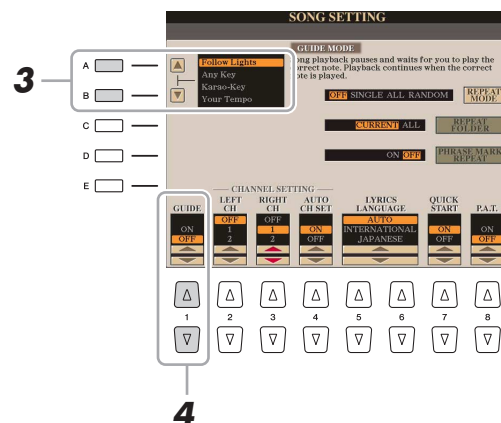

NEXT PAGE

Guide menu for keyboard practice

- **Follow Lights**

When this is selected, Song playback pauses, waiting for you to play the notes correctly. When you play the correct notes, Song playback continues. Follow Lights was developed for the Yamaha Clavinova series. This function is used for practicing purposes, with built-in lamps on the keyboard indicating the notes to be played. Even though the Tyros5 does not have these lamps, you can use the same function by following the indications in the displayed notation with the Song Score function.

- **Any Key**

With this function, you can play the melody of a Song just by pressing a single key (any key is OK) in time with the rhythm. Song playback pauses and waits for you to play any key. Simply play a key on the keyboard in time with the music and Song playback continues.

- **Your Tempo**

The same as Follow Lights, except that Song playback matches the speed at which you play.

Guide menu for singing

- **Karao-Key**

This function lets you control the Song playback timing with just one finger, while you sing along. This is useful for singing to your own performance. Song playback pauses, waiting for you to sing. Simply play any key on the keyboard (playing the keyboard produces no sound) and Song playback continues.

4 Use the [1 ▲▼] button to turn the Guide function ON.

“G” indication is shown in the Song name box on the Main display.

5 Call up the Score display by pressing the [SCORE] button.

6 Press the SONG [▶/■] (PLAY/PAUSE) button to start playback.

Practice playing the keyboard or singing, along with the Guide type selected in step 3.

7 Press the [■] (STOP) button to stop playback.

NOTE

You can save the Guide settings as a part of the Song data (page 71). For Songs to which the Guide settings have been saved, the Guide function will be automatically turned on and the related settings will be recalled when the Song is selected.

Playing Backing Parts with the Performance Assistant Technology

This feature lets you play your own backing parts on the keyboard along with Song playback, and have them sound perfectly appropriate (even though you might be playing wrong notes).

1 Select a Song containing chord data.

The Performance Assistant Technology function can be applied only to Songs containing chord data. To confirm whether the selected Song contains chord data or not, return to the Main display then start playback. If the current Song contains chord data, the Main display shows the current chord type. After stopping playback, go to the next step.

2 Call up the operation display.

[FUNCTION] → [B] SONG SETTING

3 Press the [8 ▲] button to turn P.A.T. (Performance Assistant Technology) on.

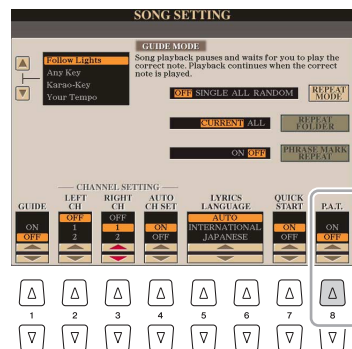

4 Press the SONG [▶/||] (PLAY/PAUSE) button to start playback.

5 Play the keyboard.

Along with Song playback, try playing the bass line with the left hand area while playing various phrases or chords with the right hand area. Even if you do not know what notes should be played, don't worry and play any keys as desired! Only the harmonically "correct" notes matching the current chord are sounded, regardless of the notes you actually play.



Current chord



6 Press the [■] (STOP) button to stop playback.

7 Press the [8 ▼] button to turn P.A.T. off.



Selecting another Song may reset P.A.T. to OFF.

Creating/Editing Songs (Song Creator)

The Owner's Manual covers how to create an original Song by recording your keyboard performance (called "Realtime Recording"). This Reference Manual shows how to create an original Song by entering notes one by one (called "Step Recording") and how to improve an already created Song by editing the detailed parameters.

Realtime Recording and Step Recording

When creating a Song, these two Recording methods are available. With Realtime Recording, this instrument records the performance data as it is played. With Step Recording, you can compose your performance by "writing" it down one event at a time.

This chapter primarily covers the instructions for Step Recording.

MIDI Song Data Structure

A MIDI Song consists of 16 MIDI channels. You can create data of a MIDI Song by recording your performance to a specific channel or channels in realtime, or by executing the Step Recording.

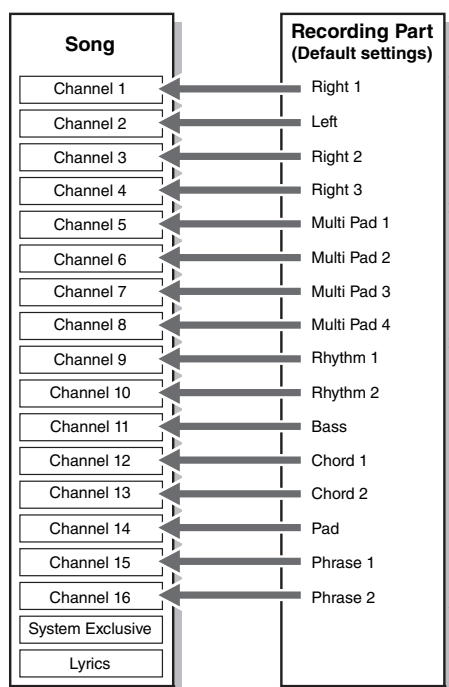

Keyboard Performance

Realtime Recording:

By default, your keyboard performance will be recorded to MIDI channels 1–4. If you use an Ensemble Voice when recording, the performances of Parts 1, 2, 3 and 4 will be recorded to Channels 2, 1, 3, and 4 respectively.

Step Recording:

Without specifying the keyboard part, you can input the melodies or notes on the music notation sheet one by one to the desired channel.

Multi Pad playback

Realtime Recording:

By default, Multi Pad playback will be recorded to MIDI channels 5–8.

Step Recording:

Multi Pad playback events cannot be input via Step Recording.

Style playback

Realtime Recording:

By default, Style playback will be recorded to MIDI channels 9–16.

Step Recording:

After inputting the Chord change/Section change events, touch [Expand] to actually record the note data to MIDI channels 9–16.

Song Creator Display Structure

The Song Creator can be called up via [CREATOR] → [A] SONG CREATOR.

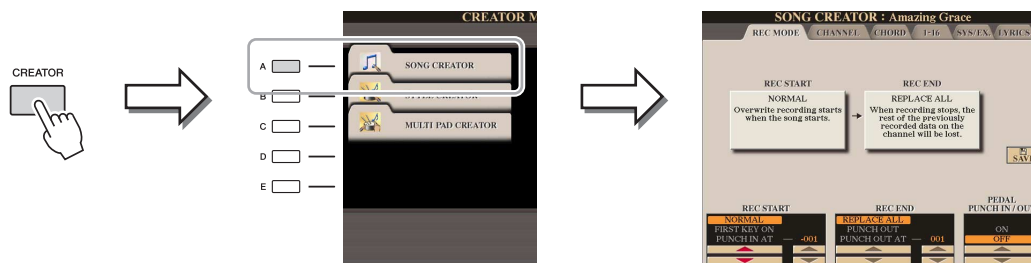

There are six Pages (tabs) in the Song Creator display.

- **REC MODE** For re-recording a Song. See [page 67](#).
- **CHANNEL** For editing Channel events. See [page 69](#).
- **CHORD** For recording chords and Sections with precise timing ([page 64](#)) or edits them ([page 72](#)).
- **1-16** For recording melodies (Step Recording; see below) or edits the recorded melodies ([page 72](#)).
- **SYS/EX** For editing System Exclusive events (tempo, time signature, etc.). See [page 72](#).
- **LYRICS** For inputting/editing a Song name and lyrics. See [page 72](#).

Recording Melodies (Step Recording)

- From the Main display, press the SONG [REC] and SONG [■] (STOP) buttons simultaneously.

A blank Song (“New Song”) is called up for recording.

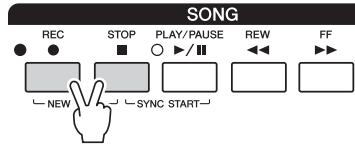

- Call up the operation display.

[CREATOR] → [A] SONG CREATOR → TAB [◀][▶] 1-16

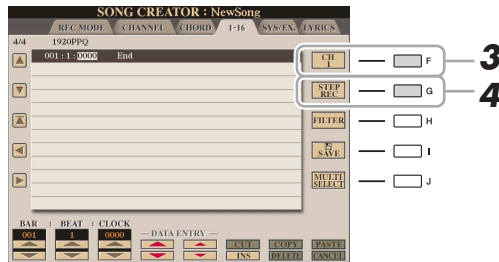

- Press the [F] button to select the channel for recording.



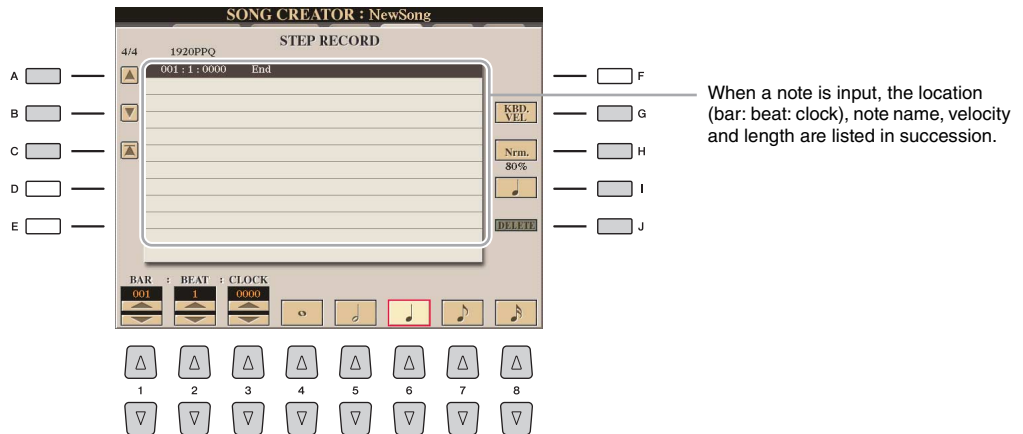

- Press the [G] (STEP REC) button to call up the STEP RECORD display.

- To execute Step Recording, use the [A]–[J] buttons and [1 ▲▼]–[8 ▲▼] buttons, as well as the keyboard.

Refer to the example on [page 62](#) for specific instructions.



NEXT PAGE

[A]/[B]/ [C]		For moving the cursor through the event list.
[G]		Determines the velocity (loudness) of the note to be entered. The velocity value can be specified within a range from 1 to 127. The higher the velocity value, the louder the sound becomes. KBD.VEL: Actual resulting velocity fff: 127 ff: 111 f: 95 mf: 79 mp: 63 p: 47 pp: 31 ppp: 15
[H]		Determines the gate time (actual length) of the note to be entered. Normal: 80%  Tenuto: 99%  Staccato: 40%  Staccatissimo: 20%  Manual: The gate time can be set to any desired percentage by using the [DATA ENTRY] dial.
[I]		Determines the note type to be entered: normal, dotted or triplet.
[J]	DELETE	Deletes the data of the current line.
[1 ▲▼]	BAR	Sets the position of the note to be entered. Note that a quarter note has a resolution of 1,920 clocks.
[2 ▲▼]	BEAT	
[3 ▲▼]	CLOCK	
[4 ▲▼]– [8 ▲▼]		Determines the note length to be entered: whole-note, half-note, quarter-note, eighth-note or sixteenth-note.

- 6** Press the SONG [■] (STOP) button (or press the [C] button) to return to the top of the Song, then play back the newly entered Song by pressing the [▶/||] (PLAY/PAUSE) button.

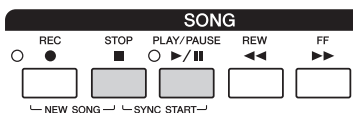

- 7** Press the [EXIT] button to exit from the Step Recording display.

- 8** Press the [I] (SAVE) button to execute the Save operation.

NOTICE

The recorded Song data will be lost if you select another Song or turn the power to the instrument off without executing the Save operation.

Example of Step Recording—Melodies (detailed instructions of Step 5 on page 60)

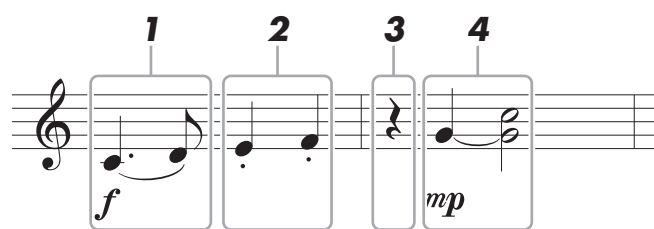

* The numbers shown in the illustration correspond to the following operation step numbers.

In this example, keep in mind that one of the steps (Step 4) involves holding down a key on the keyboard while executing the operation.

Before executing the instructions below, select the desired Voice on the STEP RECORD display. Note that only the Voice selection and Note input are possible during Step Recording.

NOTE

Since the actual note length (determined via the Gate Time) may differ from the note length on the notation, the Score of the Song recorded here may be different from the notation above.

1 Enter the first and second notes with a slur.

1-1 Press the [G] button to select “f.”

1-2 Press the [H] button to select “Tenuto.”

1-3 Press the [I] button to select the “dotted” note type.

1-4 Select the dotted quarter-note by using the [6 ▲▼] buttons.

1-5 Play the C3 key.

This enters the first note.

1-6 Press the [I] button to select the “normal” note type.

1-7 Press the [7 ▲▼] button to select the eighth-note length.

1-8 Play the D3 key.

This enters the second note.

2 Enter the next notes and apply staccato.

2-1 Press the [H] button to select “Staccato.”

2-2 Press the [6 ▲▼] button to select the quarter-note length.

2-3 Play the keys E3 and F3 in order.

This completes the first measure.

3 To enter a quarter-note rest, press the [6 ▲▼] button again.

To enter the rest, use the [4 ▲▼]–[8 ▲▼] buttons. (Press the button once to select the rest value, and once again to actually enter it.) The BAR:BEAT:CLOCK indication at the lower left lets you confirm that a rest having the specified note length has been entered.



4 Enter the next notes and apply a tie.

4-1 Press the [G] button to select “mp.”

4-2 Press the [H] button to select “Normal.”

4-3 While holding G3 key on the keyboard, press the [6 ▲▼] button.

This operation advances the input position from the current 2nd beat to the next 3rd beat. Do not release the G3 key yet. Keep holding it while executing the following steps.

4-4 While holding the G3 key, press the C4 key.

Do not release the G3 and C4 keys yet. Keep holding the notes while executing the following step.



4-5 While holding the keys G3 and C4, press the [5 ▲▼] button.

After pressing the button, release the keys.

This enters the notes G3 and C4 notes have been entered as shown in the notation on the previous page.

5 To play back your newly entered Song, press the SONG [■] (STOP) button (or press the [C] button) to return to the top of the Song, then press the [▶/■] (PLAY/PAUSE) button.

Recording Chords (Step Recording)

In Step Recording, you can record the precise change timing of chords and Sections (such as Intro, Main and Ending) of the current Style on the single display. After the operations are finished, the recorded events or settings will be converted to actual MIDI notes or Song data.

- From the Main display, press the SONG [REC] and SONG [■] (STOP) buttons simultaneously.

A blank Song (“New Song”) is called up for recording.



Selecting a blank Song initializes the panel settings.

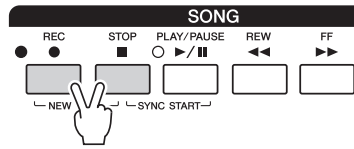

- Select the Style you want to use in the Song.

- Call up the operation display.

[CREATOR] → [A] SONG CREATOR → TAB [◀|▶] CHORD

- Press the [G] (STEP REC) button to call up the STEP RECORD display.

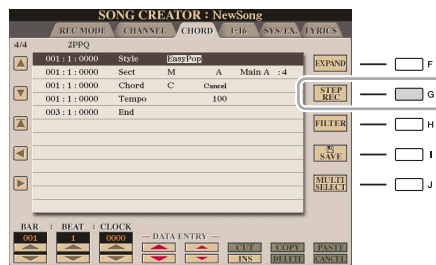

- Execute Step Recording by using the [A]–[J] buttons and [1 ▲▼]–[8 ▲▼] buttons.

Refer to the example on [page 65](#) for specific instructions.

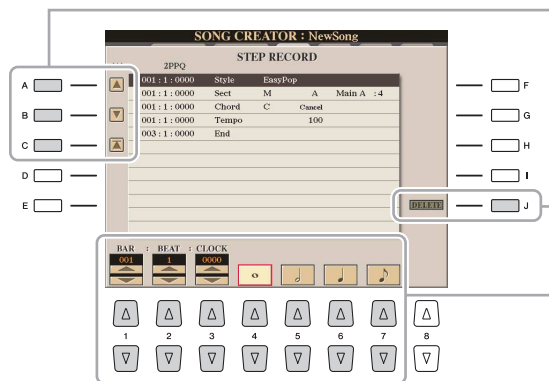

For details on these functions, refer to [page 61](#).

- Press the SONG [■] (STOP) button (or press the [C] button) to return to the top of the Song, then play back the newly entered Song by pressing the [▶|■] (PLAY/PAUSE) button.

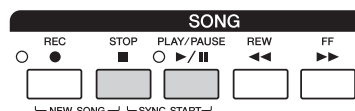

- 7** Press the [EXIT] button to exit from the Step Recording display.
- 8** Press the [F] (EXPAND) button to convert the recorded data to actual MIDI notes (Song data).
- 9** Press the [I] (SAVE) button to execute the Save operation.

NOTICE

The recorded Song data will be lost if you select another Song or turn the power to the instrument off without executing the Save operation.

Example of Step Recording—Chord (detailed instructions of Step 5 on page 64)

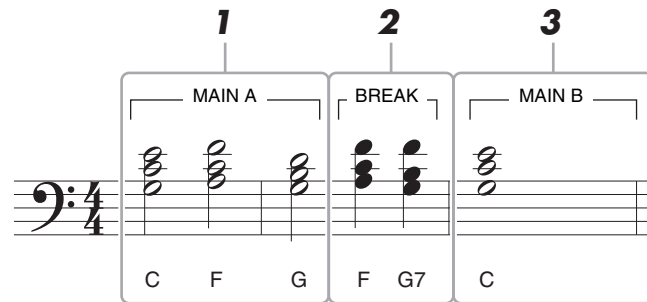

* The numbers shown in the illustration correspond to the following operation step numbers.

Before executing the instructions below, make sure that the [AUTO FILL IN] button is turned off since no Fill in is included in the notation example above.

NOTE

This example uses a Style in 4/4 time.

1 Enter the chords for the Main A section.

- 1-1** Press the STYLE CONTROL [MAIN A] button.
- 1-2** Press the [5 ▲▼] button to select the half-note length.
- 1-3** Play the chords C, F and G in the chord section of the keyboard.

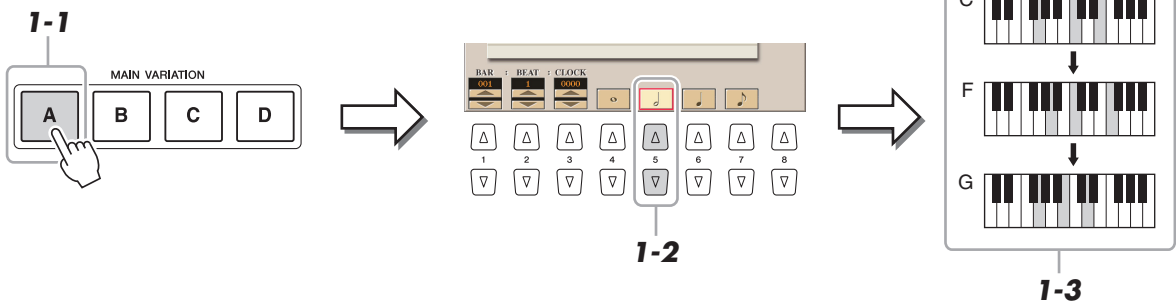

NEXT PAGE

2 Enter the chords for the Break section.

- 2-1** Press the STYLE CONTROL [BREAK] button.
- 2-2** Press the [6 ▲▼] button to select the quarter-note length.
- 2-3** Play the chords F and G7 in the chord section of the keyboard.

NOTE

If you want to record a Fill In Section, turn on the [AUTO FILL IN] button, then press one of the MAIN VARIATION [A]–[D] buttons.

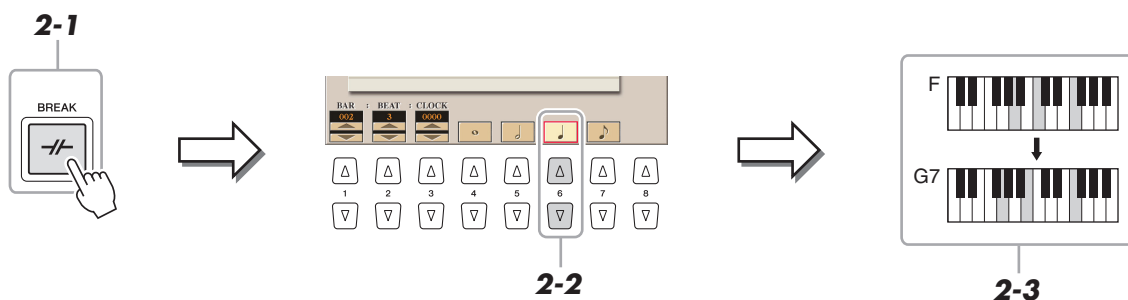

3 Enter the chords for the Main B section.

- 3-1** Press the STYLE CONTROL [MAIN B] button.
- 3-2** Press the [4 ▲▼] button to select the whole-note length.
- 3-3** Play the chord C in the chord section of the keyboard.

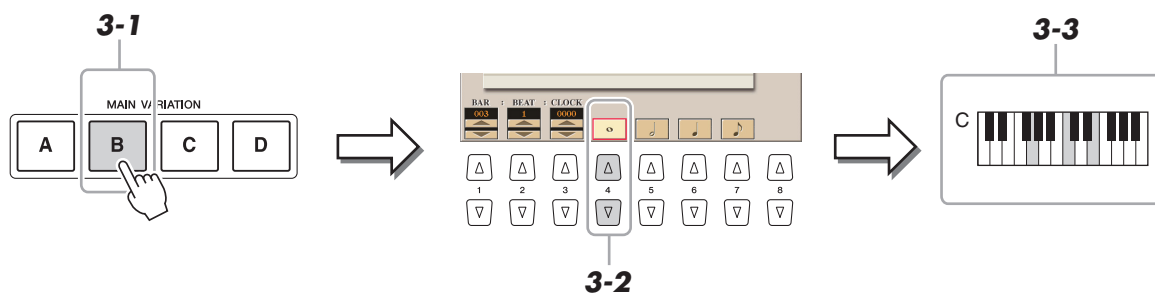

Re-Recording a Specific Section—Punch In/Out (Realtime Recording)

When re-recording a specific section of an already-recorded Song, use the Punch IN/OUT function. In this method, only the data between the Punch In point and the Punch Out point is overwritten with the newly recorded data. Keep in mind that the notes before and after the Punch In/Out points are not recorded over, although you will hear them play back normally to guide you in the Punch In/Out timing.

- 1** Select the desired Song for re-recording.
- 2** Call up the operation display.
[CREATOR] → [A] SONG CREATOR → TAB [◀][▶] REC MODE
- 3** Determine the settings for recording.

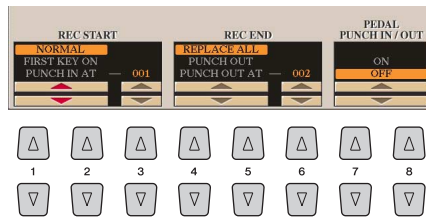

<p>[1 ▲▼]– [3 ▲▼]</p>	<p>REC START (Punch In)</p>	<p>Determines the Punch In timing.</p> <p>NORMAL: Overwrite recording starts when the Song playback is started via the SONG [▶/■] (PLAY/PAUSE) button or when you play the keyboard in the Synchro Standby mode.</p> <p>FIRST KEY ON: The Song plays back normally, then starts overwrite recording as soon as you play the keyboard.</p> <p>PUNCH IN AT: The Song plays back normally up to the beginning of the indicated Punch In measure, then starts overwrite recording at that point. You can set the Punch In measure by pressing the [3 ▲▼] button.</p>
<p>[4 ▲▼]– [6 ▲▼]</p>	<p>REC END (Punch Out)</p>	<p>Determines the Punch Out timing.</p> <p>REPLACE ALL: This deletes all data after the point at which recording is stopped.</p> <p>PUNCH OUT: The Song position at which recording is stopped is regarded as the Punch Out point. This setting maintains all data after the point at which recording is stopped.</p> <p>PUNCH OUT AT: Actual overwrite recording continues until the beginning of the specified Punch Out measure (set with the corresponding display button), at which point recording stops and normal playback continues. This setting maintains all data after the point at which recording is stopped. You can set the Punch Out measure by pressing the [6 ▲▼] buttons.</p>
<p>[7 ▲▼]/ [8 ▲▼]</p>	<p>PEDAL PUNCH IN/OUT</p>	<p>When this is set to ON, you can use Foot Pedal 2 to control the Punch In and Punch Out points. While a Song is playing back, pressing (and holding) Foot Pedal 2 instantly enables Punch In recording, while releasing the pedal stops recording (Punch Out). You can press and release Foot Pedal 2 as often as you want during playback to punch in/out of overwrite recording. Note that the current function assignment of the Foot Pedal 2 is cancelled when the Pedal Punch In/Out function is set to ON.</p> <p>NOTE Pedal Punch In/Out operation may be reversed depending on the particular pedal you've connected to the instrument. If necessary, change the pedal polarity to reverse the control (page 134).</p>

- 4** While holding the SONG [REC] button, select the desired channel from 1–16 on the display via the [1 ▲▼]–[8 ▲▼] buttons.

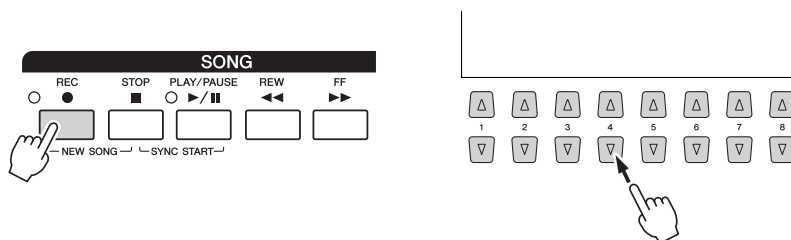

- 5** Press the SONG [▶/||] (PLAY/PAUSE) button to start Punch In/Out recording.

According to the settings in Step 3, play the keyboard between the Punch In and Punch Out points. Refer to the examples of various settings illustrated below.

- 6** Press the [I] (SAVE) button to execute the Save operation.

NOTICE

The recorded Song data will be lost if you select another Song or turn the power to the instrument off without executing the Save operation.

Examples of re-recording with various Punch In/Out settings

This instrument features several different ways you use the Punch In/Out function. The illustrations below indicate a variety of situations in which selected measures in an eight-measure phrase are re-recorded.

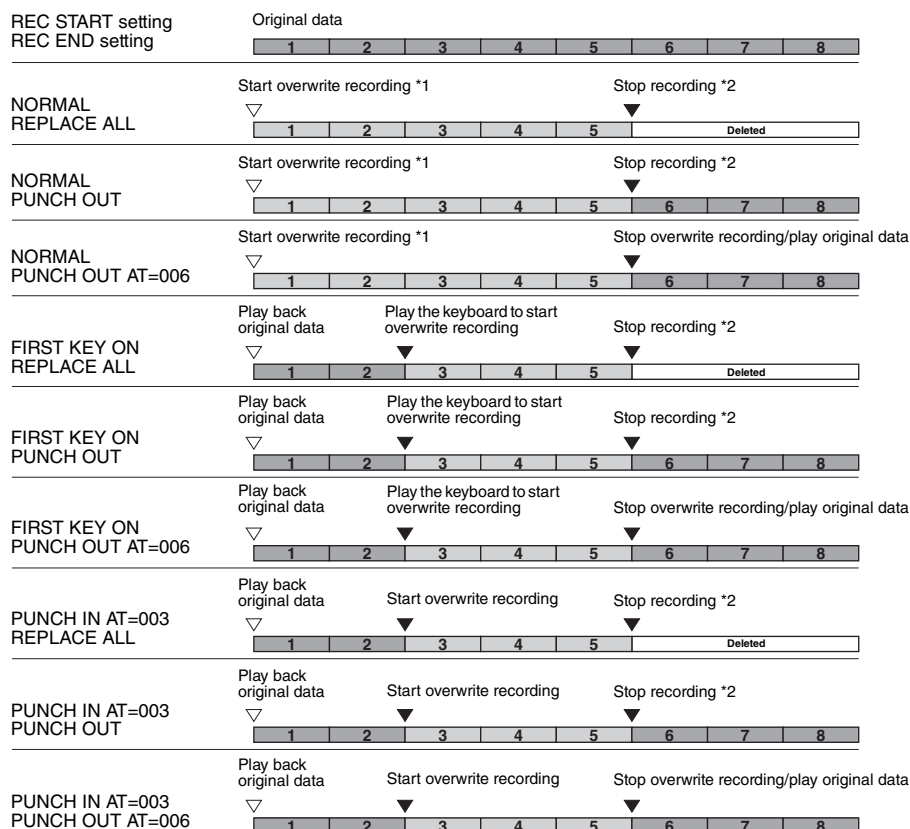

*1 If you want to re-record from the 3rd measure in this setting, move the Song position to the 3rd measure then start Recording to avoid overwriting measures 1–2.

*2 To stop recording, press the [REC] button at the end of measure 5.

Previously recorded data
Newly recorded data
Deleted data

Editing Channel Events of Existing Song Data

You can apply various useful functions to already recorded data, such as Quantize and Transpose, on the CHANNEL page.

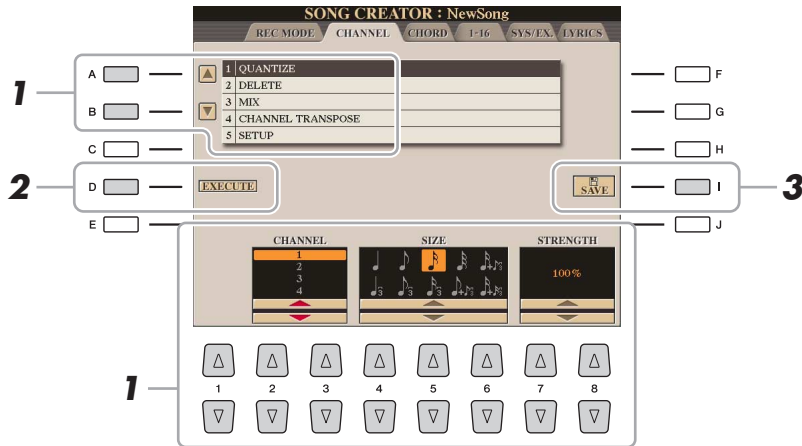

1 Select a Song to be edited.

2 Call up the operation display.

[CREATOR] → [A] SONG CREATOR → TAB [◀][▶] CHANNEL

3 Use the [A]/[B] buttons to select the edit menu, then edit the data by using the [1 ▲▼]–[8 ▲▼] buttons.

For details of the edit menu and available settings, see [page 70](#).

4 Press the [D] (EXECUTE) button to execute the operation for the current display.

After the operation (with the exception of the SETUP menu) is completed, this button changes to “UNDO,” letting you restore the original data if you are not satisfied with the operation results. The Undo function only has one level; only the previous operation can be undone.

5 Press the [I] (SAVE) button to execute the Save operation.

NOTICE

The recorded Song data will be lost if you select another Song or turn the power to the instrument off without executing the Save operation.

1 QUANTIZE

The Quantize function allows you to align the timing of all the notes in a channel. For example, if you record the musical phrase shown at right, you may not play it with absolute precision, and your performance may have been slightly ahead of or behind the precise timing. Quantize is a convenient way of correcting for this.

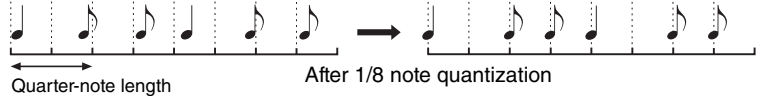
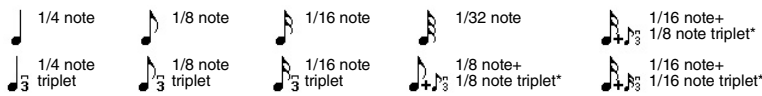
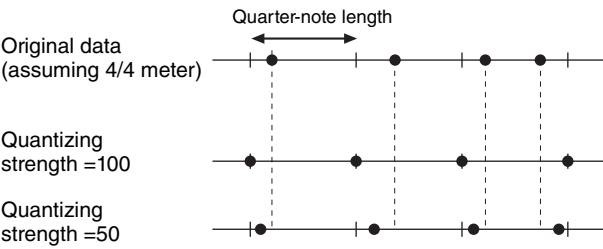

[2 ▲▼]/ [3 ▲▼]	CHANNEL	Determines which MIDI channel in the Song data is to be quantized.
[4 ▲▼]- [6 ▲▼]	SIZE	<p>Selects the quantize size (resolution). For optimum results, you should set the Quantize size to the shortest note value in the channel. For example, if eighth notes are the shortest in the channel, you should use eighth note as the Quantize size.</p>  <p>Settings:</p>  <p>The three Quantize settings marked with asterisks (*) are exceptionally convenient, since they allow you to quantize two different note values at the same time. For example, when the straight eighth notes and eighth notes triplet are contained in the same channel, if you quantize by the straight eighth notes, all notes in the channel are quantized to straight eighth notes—completely eliminating any triplet feel. However, if you use the eighth note + eighth note triplet setting, both the straight and triplet notes will be quantized correctly.</p>
[7 ▲▼]/ [8 ▲▼]	STRENGTH	<p>Determines how strongly the notes will be quantized. A setting of 100% produces exact timing. If a value less than 100% is selected, notes will be moved toward the specified quantization beats according to the specified percentage. Applying less than 100% quantization lets you preserve some of the “human” feel in the recording.</p> 

2 DELETE

You can delete the data of the specified channel in the Song. Select the channel whose data to be deleted by using the [1 ▲▼]–[8 ▲▼] buttons, then press the [D] (EXECUTE) button to execute the operation.

3 MIX

This function lets you mix the data of two channels and place the results in a different channel. It also lets you copy the data from one channel to another.

[2 ▲▼]/ [3 ▲▼]	SOURCE 1	Determines the MIDI channel (1–16) to be mixed. All MIDI events of the channel specified here are copied to the destination channel.
[4 ▲▼]/ [5 ▲▼]	SOURCE 2	Determines the MIDI channel (1–16) to be mixed. Only note events of the channel specified here are copied to the destination channel. In addition to the values 1–16, there is a “COPY” setting that allows you to simply copy the data from Source 1 to the destination channel.
[6 ▲▼]/ [7 ▲▼]	DESTINATION	Determines the channel into which the mix or copy results will be placed.

4 CHANNEL TRANSPOSE

This allows you to transpose the recorded data of individual channels up or down by a maximum of two octaves in semitone increments.

[F]	CH 1–8/CH 9–16	Toggles between the two channel displays: Channels 1–8, and Channels 9–16.
[G]	ALL CH	To simultaneously set all channels to the same value, adjust the Channel Transpose for one of the channels while holding down this button.

NOTE

Make sure not to transpose channels 9 and 10. In general, Drum Kits are assigned to these channels. If you transpose the channels of Drum Kits, the instruments assigned to each key will be changed.

5 SETUP

The current settings of the Mixing Console display and other panel settings can be recorded to the top position of the Song as the Setup data. The Mixing Console and panel settings recorded here are automatically recalled when the Song starts.

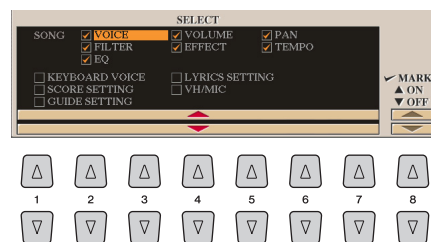

NOTE

Before executing the Setup operation, move the Song position to the top of the Song by pressing the SONG [■] (STOP) button.

[1 ▲▼]– [7 ▲▼]	SELECT	<p>Determines which playback features and functions will be automatically called up along with the selected Song. The items selected here can be recorded only to the top position of the Song, except for the KEYBOARD VOICE.</p> <p>SONG: Records the tempo setting and all settings made from the Mixing Console.</p> <p>KEYBOARD VOICE: Records the panel settings, including the Voice selection of the keyboard parts (RIGHT 1, 2, and LEFT) and their on/off status. Panel settings recorded here are same as the ones memorized to the One Touch Setting. This can be recorded at any point in a Song.</p> <p>SCORE SETTING: Records the settings in the Score display.</p> <p>GUIDE SETTING: Records the settings of the Guide functions including the Guide ON/OFF setting.</p> <p>LYRICS SETTING: Records the settings in the Lyrics display.</p> <p>VH/MIC: Records the microphone and the Vocal Harmony settings. For details about the parameters, refer to the Parameter Chart in the Data List.</p>
[8 ▲]	MARK ON	Add or remove a checkmark to the selected item. Checked items are recorded to the Song.
[8 ▼]	MARK OFF	

Editing Chord Events, Notes, System Exclusive Events and Lyrics

You can edit chord events, note events, System Exclusive events and lyrics in the same manner on the corresponding displays: CHORD, 1-16, SYS/EX and LYRICS. These are called “Event List” displays because the recorded events are shown in a list view.

NOTE

After you edit events in the CHORD tab display, press the [F] (EXPAND) button to convert the data into Song data.

NOTE

Chord section data recorded with Real-time Recording cannot be indicated and edited on this display.

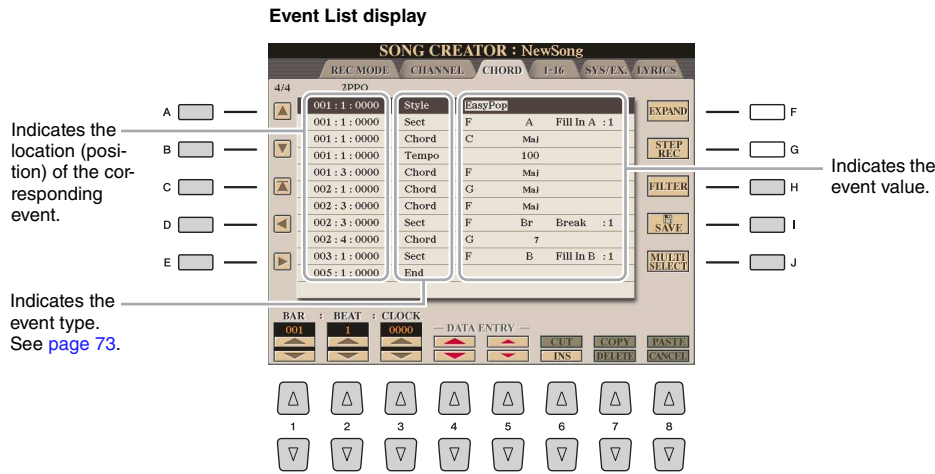

[A]/[B]		Moves the cursor up/down and selects the desired event.
[C]		Moves the cursor to the top (beginning of the Song).
[D]/[E]		Moves the cursor left/right and selects the desired parameter of the highlighted event.
[H]	FILTER	Calls up the Filter display (page 74), letting you select only the events you wish to be shown in the event list.
[I]	SAVE	Press to save the edited Song.
[J]	MULTI SELECT	Holding this button while using the [A]/[B] buttons lets you select multiple events.
[1 ▲▼]	BAR	Determines the position (bar/beat/clock) of the data. One clock is equal to 1/1920th of a quarter note.
[2 ▲▼]	BEAT	
[3 ▲▼]	CLOCK	
[4 ▲▼]/ [5 ▲▼]	DATA ENTRY	Adjusts the event value. For coarse adjustment, use the [4 ▲▼] buttons. For fine adjustment, use the [5 ▲▼] buttons or the [DATA ENTRY] dial.
[6 ▲]	CUT	Executes the cut/copy/delete/paste operation.
[7 ▲]	COPY	
[7 ▼]	DELETE	
[8 ▲]	PASTE	
[6 ▼]	INS (INSERT)	Adds a new event.
[8 ▼]	CANCEL	Cancels editing and restores the original value.

Chord Events (CHORD Page)

Style	Style
Tempo	Tempo
Chord	Chord root, Chord type, On Bass Chord
Sect	Style Section (Intro, Main, Fill In, Break, Ending)
OnOff	On/off status for each part (channel) of the Accompaniment Style
CH.Vol	Volume for each part (channel) of the Accompaniment Style
S.Vol	Overall volume of the Accompaniment Style

Note Events (1-16 Page)

Note	An individual note within a Song. Includes the note number which corresponds to the key which was played, plus a velocity value based on how hard the key is played, and the gate time value (note length).
Ctrl (Control Change)	Settings to control the Voice, such as volume, pan, filter and effect depth (edited via the Mixing Console described in chapter 8), etc.
Prog (Program Change)	MIDI program change number for selecting a Voice.
P.Bnd (Pitch Bend)	Data for changing the pitch of a Voice continuously. This event is generated by controlling the PITCH BEND wheel.
A.T. (After Touch)	This event is generated when pressure is applied to a key after the note is played.

System Exclusive Events (SYS/EX. Page)

ScBar (Score Start Bar)	Determines the top measure of a Song.
Tempo	Determines the tempo value.
Time (Time signature)	Determines the time signature.
Key (Key signature)	Determines the key signature, as well as the major/minor setting, for the music score shown on the display.
XGPrm (XG parameters)	Allows you to make various detailed changes to the XG parameters. For details, refer to the “MIDI Data Format” in the Data List, available at the Yamaha website.
SYS/EX. (System Exclusive)	Displays the System Exclusive data in the Song. Keep in mind that you cannot create new data or change the contents of the data here; however, you can delete, cut, copy, and paste the data.
Meta (Meta event)	Displays the SMF meta events in the Song. Keep in mind that you cannot create new data or change the contents of the data here; however, you can delete, cut, copy, and paste the data.

Lyrics Events (LYRICS Page)

Name	Allows you to enter the Song name.
Lyrics	Allows you to enter lyrics.
Code	CR: Enters a line break in the lyrics text. LF: Clears the currently displayed lyrics and displays the next set of lyrics.

Displaying Specific Types of Events

In the Event List displays, various types of events are shown. It may sometimes be difficult to pinpoint the ones you want to edit. This is where the Filter function comes in handy. It lets you determine which event types will be shown in the Event List displays.

- 1** Press the [H] (FILTER) button in the CHORD, 1-16, SYS/EX. or LYRICS displays.
- 2** Checkmark the desired item to be displayed.

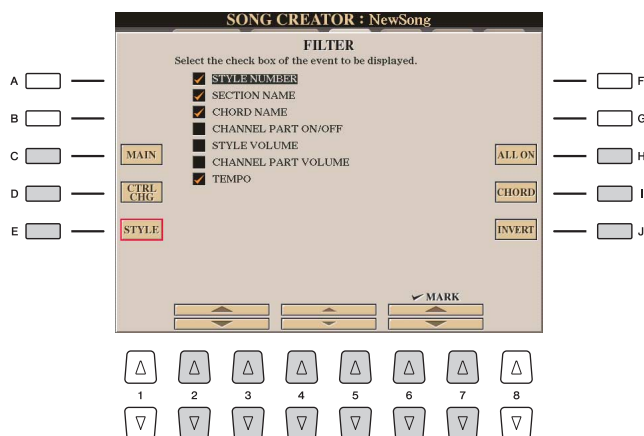

[C]	MAIN	Displays all main types of events.
[D]	CTRL. CHG	Displays all types of Control Change message events.
[E]	STYLE	Displays all types of Style playback related events.
[H]	ALL ON	Checkmarks all event types.
[I]	NOTE/ALL OFF/ CHORD	“NOTE” (shown when [C] (MAIN) is on) selects only the NOTE data. “CHORD” (shown when [E] (STYLE) is on) selects only the CHORD data. “ALL OFF” (shown when [D] (CTRL.CHG) is on) removes all checkmarks.
[J]	INVERT	Reverses the checkmark settings for all boxes. In other words, this enters checkmarks to all boxes that were previously unchecked and vice versa.
[2 ▲▼]- [5 ▲▼]		Select and event type to be checked or unchecked.
[6 ▲]/ [7 ▲]	MARK ON	Enters/removes the checkmark for the selected event type. The checked event types can be shown on the CHORD, 1-16, SYS/EX or LYRICS pages.
[6 ▼]/ [7 ▼]	MARK OFF	

- 3** Press the [EXIT] button to execute the settings.

Editing Song Position Markers

This section covers two additional Marker-related features and details. For basic information on using the Markers for jump playback and loop playback, refer to the Owner’s Manual.

■ Jump Markers

The Markers explained in the Owner’s Manual are also called “Jump Markers.” In the Event List display (page 72), they are indicated as “SPJ-01”–“SPJ-04.” In the Event List, they can be moved freely to other positions and can even be copied to create identical Marker numbers at other positions. When the same Marker number is contained at different locations in the Song, the latest occurring one is used as a “Loop End Marker” (below).

■ Loop End Marker

Loop End Markers can be used for putting additional Markers in Song data, providing even greater versatility. Creating a Loop End Marker is done within the Event List (and not with the [SP 1]–[SP 4] buttons on the panel), by simply copying one “SPJ” Jump Marker event to another position in the Song. For basic information on loop playback between successive Jump Markers, refer to the Owner’s Manual. The examples below show how Loop End Markers can be used in Song playback.

Example 1

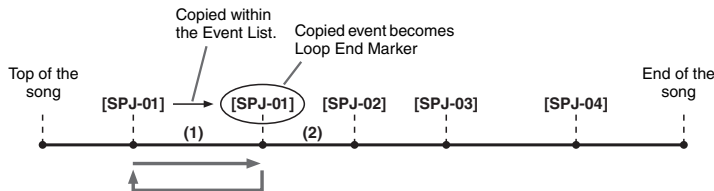

- (1) If the Song is playing back between the two SPJ-01 points, turning on [LOOP] will result in a playback loop between those points.
- (2) If the Song is playing back between the second SPJ-01 and SPJ-02 and [LOOP] is turned on, playback jumps back to the first SPJ-01 and loops between two SPJ-01 points.

Example 2

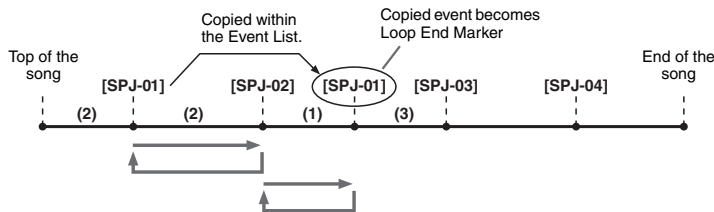

- (1) If the Song is playing back between SPJ-02 and the second SPJ-01, turning on [LOOP] will result in a playback loop between those points.
- (2) If the [LOOP] button is turned on while the Song is playing back between the top of the Song and SPJ-02, playback will loop between SPJ-01 and SPJ-02.
- (3) If the Song is playing back between the second SPJ-01 and SPJ-03 and [LOOP] is turned on, playback jumps back to SPJ-02 and loops between SPJ-02 and the second SPJ-01 (Loop End Marker).

In the examples above, the actual data of the Loop End Marker is identical to the event it was copied from—only the location of the copied Marker provides it with this different function.

In Song playback, the markers formatted as “SPJ-xxxxx” (xxxxx: any character except 01–04 and any number of letters is OK) are handled as Loop End Markers. Since the Event List in the Song Creator function does not let you freely name Markers, the instructions above are recommended for creating new Markers. However, with sequence software on a computer, you can create new Markers and assign appropriate names to them. By naming Markers in this way, you can easily distinguish between Loop End Markers and Jump Markers in the Event List.

NOTE

Loop playback problems may occur if successive Markers are too close to one another.

NOTE

When the effect settings of the jump destination (the position you’re jumping to) differ from those at the jump source, glitches or drop-outs in the sound may result. This is because of limitations in the effect processors of the Tyros5.

NOTE

When using the Guide function (page 56) with jump playback, keep in mind that the Guide indication may not be able to stay in time with the jumps.

Contents

Recording Your Performance	76
• Multi Track Recording	76
Converting a file	80
• Converting an Audio File (.wav/.mp3) to a Multi Track recording file (.aud)	80
• Converting a Multi Track Recording File (.aud) to an Audio File (.wav)	81
Editing the Recorded Data (Multi Track Recording File)	82
• (1) Normalize	83
• (2) Adjusting the Volume Balance	83
• (3) Deleting a Track.....	83
Re-recording the Multi Track Recording File.....	84
• NORMAL REC / NORMAL REC (PLUS PLAYBACK)	84
• PUNCH IN OUT / PUNCH IN OUT (MERGE)	85
Setting the Start/End Points of the Audio (Multi Track Recording File) ...	87
Playlist Mode.....	88
• Creating a Playlist	88
• Playing a Playlist.....	88
• Playlist Controls	89

Recording Your Performance

With Multi Track recording, you can record your performance several times to make up the complete song. For example, 1) record your keyboard performance to the Main track, 2) record your vocal via the microphone to the Sub track.

Multi Track File formats that can be used:

Mode		File extension	Available location	Various recording methods (Bounce, Punch In/Out, etc.)
Multi Track	Recording	.aud (Tyros5 original: 44.1 kHz sample rate, 16 bit resolution, stereo)	Internal HDD	Yes
	Playback	.aud (Tyros5 original: 44.1 kHz sample rate, 16 bit resolution, stereo)		

Multi Track Recording

This section covers the basic procedure of Multi Track recording. The operation steps can be summarized as follows: 1) Record your keyboard performance to the Main track, 2) record your vocal sound to the Sub track.

NOTE

Up to 80 minutes can be recorded continuously in a single recording operation.

- 1** Make the necessary settings such as Voice/Style selection and the microphone connection (if you want to record your vocal).

- Press the AUDIO RECORDER/PLAYER [MODE] button, repeatedly if necessary, to call up the AUDIO RECORDER/PLAYER display.

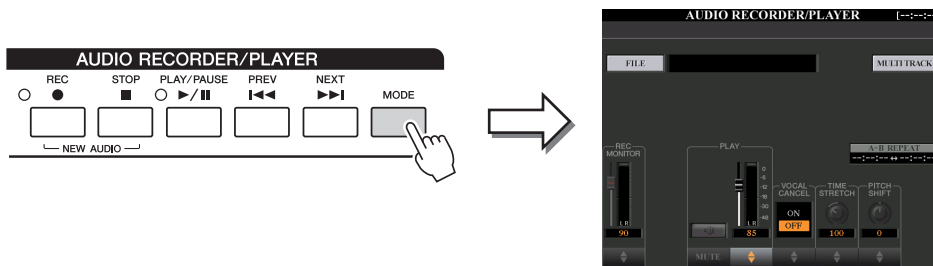

- Press the [F] (MULTI TRACK) button to call up the Multi Track Recorder display.



- Press the AUDIO RECORDER/PLAYER [REC] and [STOP] buttons simultaneously.

This operation will create a new empty audio file named “M_Audio_***.AUD.”

- Record to the Main track.

If the TRACK SELECT [F3] is not selected “MAIN” in the display, press the [F] button to select the “MAIN” as destination.

- 5-1** Press the [PLAY/PAUSE] button to start recording.
- 5-2** When your performance is finished, press the [STOP] button to stop recording.
- 5-3** To hear your new recording, press the [PLAY/PAUSE] button.

NOTICE

The data is automatically saved in the internal HDD, but you may want to backup your data from time to time. Copying is the easiest way to do this. However, since copying within a folder in the HDD is not possible, you need to create a new folder. For details on file management, refer to the Owner’s Manual.

Undo/Redo

If you’ve made a mistake or you’re not completely satisfied with your performance, you can press the Undo function to erase the take and try again.

- Press the [G] (UNDO) button.
The latest recording that you made is cancelled. If you want to restore the operation, press the [G] (REDO) button.
- Press the [REC] button to enable recording.
- Start again with Step 4 in “Multi Track Recording”.



Next, let's record your singing to the Sub track. You can record your vocals while listening to playback of the Main track.

6 Practice the part (sing into the microphone) to check the level and adjust the recording volume on the REC MONITOR meter by using the [1 ▲▼] buttons or sliders.

Adjust so that the volume doesn't constantly go into the "red" and light up the indicator. If it does, you may have to turn the microphone input level down a bit.

7 Record to the Sub track.

7-1 Press the [F] (TRACK SELECT) button to select "SUB" as destination.



NOTE

- Press the 1's [▲] and [▼] buttons simultaneously to instantly reset the recording volume to 90.
- If you call up a different display, press the [MODE] button to return to the Multi Track Recorder display.

NOTE

Make sure that the RECORDING MODE (upper left of the display) is set to "NORMAL REC" here.

7-2 Press the [REC] button to enable recording.

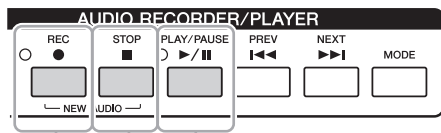

7-2 7-4 7-3, 7-5

7-3 Press the [PLAY/PAUSE] button to start recording.

Immediately after this operation, start singing along with the Main track playback.

7-4 When your performance is finished, press the [STOP] button to stop recording.

7-5 To hear your new recording, press the [PLAY/PAUSE] button.

Adjusting the volume balance

On the TRACK PLAY meter, you can adjust the volume of Main and Sub tracks separately. Use the [4 ▲▼]/[6 ▲▼] buttons or sliders to adjust the Main/Sub track volume. By using the [3 ▲▼]/[5 ▲▼] buttons, you can also mute the Main/Sub tracks.



Next, mix all data from the Main track and Sub track to one track (Main track). This procedure (below) is called Bounce recording.

8 Press the [B] (REC MODE), and then use the [B]/[C] buttons to select “BOUNCE.”

After selection, press the [EXIT] button to return to the previous display.

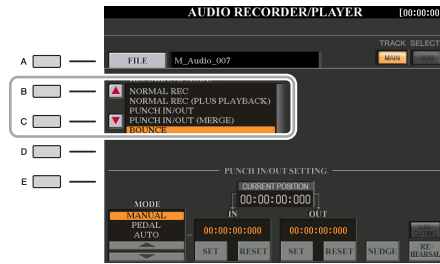

NOTE

When the Recording Mode is set to “BOUNCE,” the selected track is automatically changed to Main.

9 Press the [REC] button then press the [G] (YES) button.

If you do not want to delete the recorded data of the Sub track, press the [H] (NO) button instead of the [G] (YES) button above.

10 Press the [PLAY/PAUSE] button to start Bounce recording.

All data in Main and Sub tracks are mixed and recorded to the Main track. When playback of the Main and Sub tracks is finished, Bounce recording automatically stops.

NOTE

If you sing or play the keyboard during Bounce recording, your performance is also recorded to the Main track.

11 To hear your new recording, press the [PLAY/PAUSE] button.

The Sub track is now empty, you can continue recording another part to the Sub track, repeating Steps 6–7.

If you did not delete the recorded data of the Sub track in Step 9, the data of Sub track is recorded to both Main and Sub tracks. To avoid duplicate playback of Sub track, press the [5 ▲▼] (MUTE) button in the Multi Track Recorder display.

NOTE

- The Multi Track recording file (.aud) can be played back only on the Tyros5.
- The .aud file saved with the Multi Track recording can be converted to .wav file format (Simple recording file) by using the Mixdown function.

12 Press the [EXIT MULTI TRACK] button, then press the [G] (YES) button to exit from the Multi Track Recorder display.

At this point, the recorded data have not been processed with the Mixdown operation (converting a Multi Track recording file to a Simple recording file). If Mixdown is necessary, refer to the “Converting a Multi Track Recording File (.aud) to an Audio File (.wav)” on [page 81](#).

NOTE

You can convert the Multi Track recording file (.aud) to a Simple recording file (.wav). For details, see the “Converting a Multi Track Recording File (.aud) to an Audio File (.wav)” on [page 81](#).

Converting a file

Converting an Audio File (.wav/.mp3) to a Multi Track recording file (.aud)

You can convert audio files (.wav/.mp3), such as commercially available samples, loops, sound effects, etc., to a Multi Track recording file (.aud)—allowing you to work with the two tracks or use the various recording methods of the instrument (Bounce, Punch In/Out, etc.).

- 1** Connect the USB flash memory containing the audio file to the USB TO DEVICE terminal.
- 2** Press the AUDIO RECORDER/PLAYER [MODE] button several times to call up AUDIO RECORDER/PLAYER display.
- 3** Press the [A] (FILE) button.
- 4** Use the TAB [◀][▶] buttons to select the USB flash memory, then use the [A]–[J] buttons to select the desired audio file.
- 5** Press the [EXIT] button to return to the AUDIO RECORDER/PLAYER display.
- 6** Press the [F] (MULTI TRACK) button, then press the [F] (YES) button.
The conversion of the audio files (.wav/.mp3) to the Main track of the Multi Track recording file (.aud) is completed.
- 7** Execute the same operations from Step 7 in “Multi Track Recording” on [page 78](#).

NOTE

The conversion time to a Multi Track recording file depends on the size of the audio file (.wav/.mp3).

NOTICE

If the same file name already exists, a message appears prompting you to overwrite. Selecting [YES] converts the file and overwrites the Main track. The data of Sub track will be deleted.

Converting a Multi Track Recording File (.aud) to an Audio File (.wav)

You can convert a Tyros5 Multi Track recording file (.aud) to a Simple recording file (.wav)—allowing you to playback on devices other than the Tyros5, and also playback on the Tyros5 from the USB flash memory.

NOTE

If you want to save the file to a USB flash memory, connect the USB flash memory to the [USB TO DEVICE] terminal.

- 1** Press the **AUDIO RECORDER/PLAYER [MODE]** button several times to call up **AUDIO RECORDER/PLAYER** display.
- 2** Press the **[F] (MULTI TRACK)** button.
- 3** Press the **[A] (FILE)** button.
- 4** Use the **TAB [◀][▶]** buttons to select the USB flash memory, then use the **[A]–[J]** buttons to select the desired audio file.
- 5** Press the **[EXIT]** button to return to the **AUDIO RECORDER/PLAYER** display.
- 6** Press the **[J] (MIXDOWN)** button to call up the **MIXDOWN** display.
- 7** If necessary, press the **[B] (FILE NAME)** button, change the file name, then press the **[8 ▲] (OK)** button.
- 8** If necessary, press the **[C] (SAVE TO)** button, use the **TAB [◀][▶]** and **[A]–[J]** buttons to select the destination (to which the converted file is to be saved), then press the **[8 ▲] (OK)** button.
- 9** Press the **[G] (START)** button to start playback. As soon as playback is finished, conversion from .aud to .wav will be started.

Editing the Recorded Data (Multi Track Recording File)

You can edit the data which is recorded in Multi Track Recording.

- 1** Press the AUDIO RECORDER/PLAYER [MODE] button several times to call up the AUDIO RECORDER/PLAYER display and select the recorded data to be edited.
- 2** Press the [F] (MULTI TRACK) button to call up the Multi Track Recorder display.
- 3** Press [A] (FILE) button
- 4** Select the desired audio file by using [A]–[J] buttons.
- 5** Press [EXIT] button to return to the AUDIO RECORDER/PLAYER display.

NOTICE

The data is automatically saved in the internal HDD, but you may want to backup your data before editing. Copying is the easiest way to do this. However, since copying within a folder in the HDD is not possible, you need to create a new folder. For details on file management, refer to the Owner's Manual.

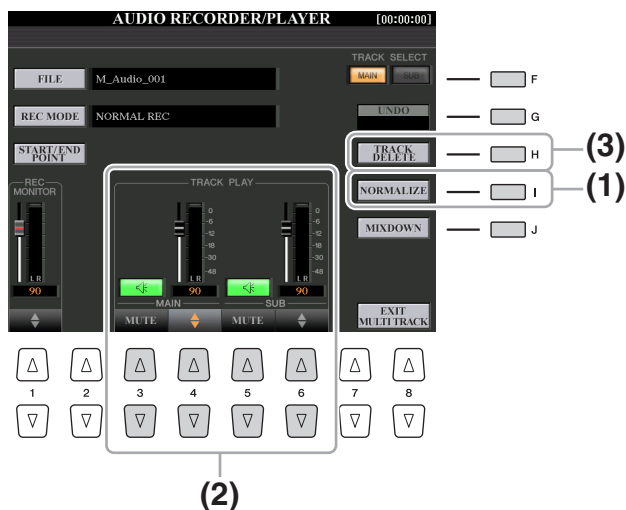

(1) Normalize

Normalize raises the volume of the recorded audio to the optimum level. Use this to make the recorded audio as loud as possible, without distortion. Technically, this operation scans the recorded file for the highest level, then raises the volume of the entire file so that the highest peak is set to the maximum, non-distorting level. Normalization is calculated for the loudest signal found in either channel of the stereo recording and the same gain is applied to both channels.

- 1 Press the [F] (TRACK SELECT) button to select the track to be normalized.**
- 2 Press the [I] (NORMALIZE) button.**
- 3 At the prompt, press the [G] (OK) button to start normalizing the selected track.**
To cancel the operation, press the [H] (CANCEL) button.

(2) Adjusting the Volume Balance

On the TRACK PLAY meter, you can adjust the volume of Main and Sub tracks separately. Use the [4 ▲▼]/[6 ▲▼] buttons or sliders to adjust the Main/Sub track volume. By using the [3 ▲▼]/[5 ▲▼] buttons, you can also mute the Main/Sub tracks.

NOTE

To control overall volume of the audio file, press the [BALANCE] button once or twice to call up the BALANCE (2/2) display, then use the [4 ▲▼] slider or buttons.

(3) Deleting a Track

- 1 Press the [F] (TRACK SELECT) button to select the track to be deleted.**
- 2 Press the [H] (TRACK DELETE) button.**
- 3 At the prompt, press the [G] (OK) button to start deleting the selected track.**
To cancel the operation and leave the track intact, press the [G] (UNDO) button, before executing any other operation.

Re-recording the Multi Track Recording File

The created Multi Track recording data can be re-recorded in the following five ways.

- Replace the whole data: NORMAL RECSee below
- Mix the recorded data: NORMAL REC (PLUS PLAYBACK).....See below
- Replace a certain range of the data: PUNCH IN/OUTSee [page 85](#)
- Overdub a certain range of the data: PUNCH IN/OUT (MERGE)See [page 85](#)
- Merge the Main and Sub tracks to the Main track: BOUNCE
..... See Multi Track Recording

NOTE

Re-recording of the data repeatedly will result in deterioration of the sound quality.

NOTICE

The data is automatically saved in the internal HDD, but you want to backup your data before re-recording. Copying is the easiest way to do this. However, since copying within a folder in the HDD is not possible, you need to create a new folder. For details on file management, refer to the Owner's Manual.

NORMAL REC / NORMAL REC (PLUS PLAYBACK)

You can replace the whole audio data of a track by NORMAL REC or mix the audio data with the previous one by NORMAL REC (PLUS PLAYBACK). The NORMAL REC (PLUS PLAYBACK) method does not add any tracks but simply mixes the new recording to the existing data. After stopping recording, any data following the stop point will be erased.

NOTE

Since you will be overdubbing parts onto this audio, it's best to keep the first recording simple. For example, you may want to record just a rhythm pattern (such as by playing back a Style) or a simple bass riff over which you can add other parts.

1 Execute Steps 1–5 in “Editing the Recorded Data (Multi Track Recording File)” on [page 82](#) to select the data to be re-recorded.

2 Use the [F] (TRACK SELECT) button to select the track to be re-recorded.

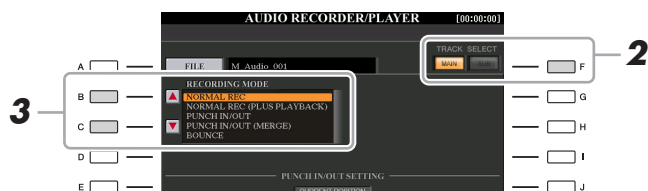

3 Use the [B]/[C] buttons to select a recording method.

- Replace the whole data: NORMAL REC
- Mix the recorded data: NORMAL REC (PLUS PLAYBACK)

4 If you select “NORMAL REC (PLUS PLAYBACK),” play back the recorded audio and practice the part that you want to overdub while the audio is playing. Change the volume settings if necessary.

If you wish to add a keyboard-played Voice from the Tyros5, select the desired Voice. If you wish to record your singing voice or an external instrument, connect a microphone or instrument and make the appropriate settings. Adjust the Track Play and Rec Monitor levels here as desired.

5 Press the [REC] button to enable recording.



6 Press the [PLAY/PAUSE] button to start recording.

Play the keyboard (or sing, etc.) and record your performance.

7 When finished recording, press the [STOP] button.

After stopping recording, the data will be erased from the stop point.

8 To hear your new recording, press the [PLAY/PAUSE] button.

If you've made a mistake or you're not completely satisfied with your performance, press the [EXIT] button to return to the AUDIO RECORDER/PLAYER display, then undo the NORMAL REC/NORMAL REC (PLUS PLAYBACK) operation by pressing the [G] (UNDO) button.

NOTE

The playback sound of the other (not yet rerecorded) track is not recorded to the track.

NOTE

The Audio Recorder/Player automatically reduces the level of the previous track by a certain, slight amount to accommodate the new recording. This is done to minimize possible distortion. You can use the Normalize effect to maximize the volume of the overall sound. For details, see [page 83](#).

PUNCH IN OUT / PUNCH IN OUT (MERGE)

This method of recording can only be used on an existing recording. It allows you to re-record over a specific part of the already-recorded material. You can replace the original part with the new recording by PUNCH IN/OUT, or keeping the original and mixing it with the new by PUNCH IN/OUT (MERGE). This lets you either correct a mistake in the recording or overdub new parts onto the original recording.

Keep in mind that the parts before and after the Punch In/Out section are not recorded over and remain as the original data—they play back normally to guide you in and out of the recording.

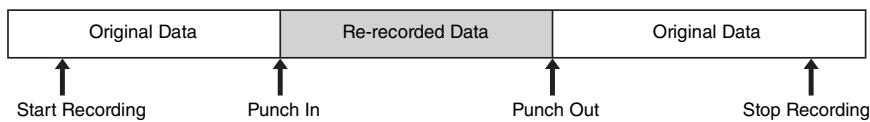

NOTE

You can re-record over only one range at one time.

NOTE

The beginning and ending of the recorded data using the Punch In/Out function is faded in/out automatically. This is done to minimize possible noise at the beginning and ending of the recorded data. We recommend that you specify the beginning and ending points at sections in the data where the volume is low.

1 Execute Steps 1–5 in “Editing the Recorded Data (Multi Track Recording File)” on [page 82](#) to select the recorded data to be re-recorded.

2 Use the [F] (TRACK SELECT) button to select the track to be re-recorded.



3 Use the [B]/[C] buttons to select a recording method.

- Replace a certain range of the data: PUNCH IN/OUT
- Overdub a certain range of the data: PUNCH IN/OUT (MERGE)



4 Select the desired Punch In/Out Mode, using the [1 ▲▼]/[2 ▲▼] (MODE) buttons.

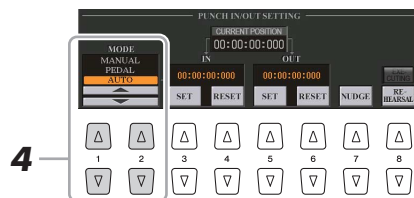

- **MANUAL** This lets you manually execute Punch In/Out recording by using the Audio Recorder/Player transport buttons ([REC], [PLAY/PAUSE], etc.).
- **PEDAL**..... This lets you manually execute Punch In/Out recording by using a connected footswitch to the FOOT PEDAL 2 jack.
- **AUTO**..... This lets you specify the Punch In and Out points, allowing automatic Punch In/Out recording (see below).

Specifying the recording range in AUTO mode

If you select AUTO as the punch in/out recording method, specify the recording range and practice the recording by using the Rehearsal function.

- 1 Specify the punch in/out range by pressing the [3 ▲▼]/[5 ▲▼] (SET) buttons at the punch in/out point during the audio song playback.
- 2 If you move the punch in/out point slightly, use the Nudge function.
In this Nudge function, you can move the punch in/out point slightly (even in millisecond units) while listening to the playback.

2-1 Press the [7 ▲▼] (NUDGE) button to show the Nudge Play display.

2-2 Use the [DATA ENTRY] dial and AUDIO RECORDER/PLAYER [PREV]/[NEXT] button to move the NUDGE DATA POSITION to the desired punch in/out position while listening to the playback (500 milliseconds loop playback before/after the specified point). The [DATA ENTRY] dial lets you adjust the point in seconds and the [PREV]/[NEXT] buttons lets you adjust in milliseconds.



2-3 Press the [7 ▲▼] (MODE) button to select After/Before. “After” repeats 500 milliseconds after the Nudge Data Position and “Before” repeats 500 milliseconds before the Nudge Data Position when you playback the data in the next step.

2-4 Press the [3 ▲▼]/[5 ▲▼] (SET) button to set the moved point. To reset the point to the start/end point of the data, press the [4 ▲▼]/[6 ▲▼] (RESET) button.

2-5 Press the [8 ▲▼] (CLOSE) button.

NOTE

The smallest possible range of the Auto punch in/out function is 100 milliseconds.

- 3 Use the REHEARSAL function to practice the recording before the actual recording.
 - 3-1** Press the [8 ▲▼] (REHEARSAL) button. “EXECUTING” is shown above the [8 ▲▼] buttons.
 - 3-2** Press the AUDIO RECORDER/PLAYER [REC] button and press the [PLAY/PAUSE] button.
The audio song is played back repeatedly starting four seconds before the punch in point to four seconds after the punch out point. Play the keyboard or sing the desired part in practice. In this rehearsal function, recording is not started.
 - 3-3** Press the AUDIO RECORDER/PLAYER [STOP] button.

NOTE

Repeat playback of the rehearsal function is automatically stopped after playing back 99 times.

5 Record the specific part of the audio song using the one of the methods below.

NOTE

The playback sound of the other (not yet rerecorded) track is not recorded to the track.

Manual

Press the AUDIO RECORDER/PLAYER [REC] button and press the [PLAY/PAUSE] button to engage the record mode, then press the [REC] and [PLAY/PAUSE] buttons simultaneously to actually record. To stop recording, press the AUDIO RECORDER/PLAYER [STOP] button. Pressing the AUDIO RECORDER/PLAYER [PLAY/PAUSE] button during recording pauses the recording.

Pedal

Press the AUDIO RECORDER/PLAYER [REC] button and press the [PLAY/PAUSE] button to engage the record mode, then press and hold the footswitch. The point at which you press the footswitch is the punch in point and the point at which you release the pedal is the punch out point.

Auto

Press the AUDIO RECORDER/PLAYER [REC] button and press the [PLAY/PAUSE] button. Recording automatically starts and stops at the specified point in “Specifying the recording range in AUTO mode” on [page 86](#). The audio song playback automatically stops four seconds after the punch out point.

6 To hear your new recording, press the [PLAY/PAUSE] button.

If you’ve made a mistake or you’re not completely satisfied with your performance, press the [EXIT] button to return to the Multi Track Recorder display then undo the Punch In/Out operation by pressing the [G] (UNDO) button.

Setting the Start/End Points of the Audio (Multi Track Recording File)

This function lets you set the Start and End points for the audio file. This action is non-destructive and affects only the playback of the data; it does not actually delete any data from the start or end of the file.

1 Execute Step 1–5 in “Editing the Recorded Data (Multi Track Recording File)” on [page 82](#) to select the desired audio data.

2 Press the [C] (START/END POINT) button.

3 Specify the Start/End point.

The operation of specifying the Start/End points is same as specifying the punch in/out points. For instructions, see “Specifying the recording range in AUTO mode” on [page 86](#).

4 Press the [F] (OK) button to enter the new settings to the file.

To cancel the operation, press the [G] (CANCEL) button.

NOTICE

The data is automatically saved in the internal HDD, but you want to backup your data before re-recording. Copying is the easiest way to do this. However, since copying within a folder in the HDD is not possible, you need to create a new folder. For details on file management, refer to the Owner’s Manual.

Playlist Mode

The Playlist is a convenient feature within the Audio Recorder/Player that lets you collect and organize audio files for automatic playback in “jukebox” fashion. The Playlist mode can be active in the background (for example, when the Main display is selected), letting you play the listed files whenever you wish during your performance.

The “REPEAT” icon (see [page 89](#)) at the upper left of the display shows that the Audio Recorder/Player is set to the Playlist mode (automatic playback of multiple files).

Creating a Playlist

Once you have a number of audio files on the internal hard disk drive, you can add those files to the Playlist. The files can be put in any order and can be entered any number of times (in other words, a single file can have multiple instances in a Playlist).

NOTE

A Playlist can contain a maximum of 500 audio files.

1 Press the **AUDIO RECORDER/PLAYER [MODE]** button several times to call up the **AUDIO PLAYER/RECORDING** display.

2 Press **[A] (FILE)** button, then use the **TAB [◀][▶]** buttons to select the location (**HD** or **USB**) of the desired audio file.

NOTE

You cannot add the Multi Track (.aud) audio data to the Playlist.

3 Add the desired audio file to the Playlist.

3-1 Press the **[6 ▲] (ADD TO PLAYLIST)** button.

The selected file name is highlighted. You can continue to select additional files here, as many as desired. If multiple pages (**P1**, **P2**, ...) are shown at the bottom, you can select files from these displays, too. To select all the files in the current folder, press the **[6 ▼] (ALL)** button.

3-2 Press the **[7 ▼] (OK)** button to confirm the selection.

NOTE

If you want to select all but a few of the files in the folder, a quick method is to use the **[6 ▼] (ALL)** button to select all of the files, then use the **[A]–[J]** buttons to de-select specific files.

4 Press the **[EXIT]** button.

5 Press the **AUDIO RECORDER/PLAYER [MODE]** button several times to call up the **PLAYLIST** display, then check the Playlist to confirm that the files have been added.

If the Playlist already has audio files, additional files are automatically put at the end of the list. Added files are also automatically selected (checkmarked) for playback.

NOTE

If you change the file icon after adding to the Playlist, the audio file cannot be recognized from the Playlist.

6 Save the Playlist.

Press the **[1 ▲▼] (FILES)** button, then save the Playlist to the **USER** drive, internal hard disk drive or **USB** flash memory.

Playing a Playlist

Once you’ve created and/or edited a Playlist and you’ve enabled the Playlist mode, you can play back the files in the list—at any time during your performance.

Keep in mind that playback of files is not instantaneous. Since the Audio Recorder/Player needs to load each file before playing it, playback pauses roughly one or two seconds between files.

1 Press the **AUDIO RECORDER/PLAYER [MODE]** button several times to call up the **PLAYLIST** display.



2 Press the [1 ▲▼] (FILES) buttons to call up the PLAYLIST FILE display, then select the desired Playlist by using the [A]–[J] buttons.

NOTE

The [SELECT] button toggles between the Audio and Playlist displays within the Audio Recorder/Player function.

3 Press the [EXIT] button to return to the PLAYLIST display.

4 Use the [5 ▲▼]/[6 ▲▼] buttons to select a file for playback, then actually enter it by pressing the [7 ▲▼] (SELECT) button.

You can also use the [DATA ENTRY] dial to move the cursor and press the [ENTER] button to actually select the song.

To have the files play back from the beginning of the Playlist, select the first file. A check mark indicates the file is enabled for playback, a minus sign (-) indicates the file will be skipped, and an exclamation mark indicates the file does not contain data.

5 Press the AUDIO RECORDER/PLAYER [PLAY/PAUSE] button to start playback of the Playlist from the selected file.

While the Playlist mode is active (the indicator at the top left of the display shows the “REPEAT” icon; page 89), the AUDIO RECORDER/PLAYER [PREV]/[NEXT] buttons function as Previous/Next controls for the Playlist. Pressing the appropriate button calls up a pop-up window and selects the previous or next audio file in the Playlist. You can use the AUDIO RECORDER/PLAYER [PLAY/PAUSE] button to pause and resume play at any time during your performance.

6 Press the AUDIO RECORDER/PLAYER [STOP] button to stop playback.

To disengage the Playlist mode, press the AUDIO RECORDER/PLAYER [MODE] button several times to call up the Audio Recorder/Player display, then select an audio file.

Playlist Controls

Shown here is a sample Playlist display, with short explanations of the various controls.

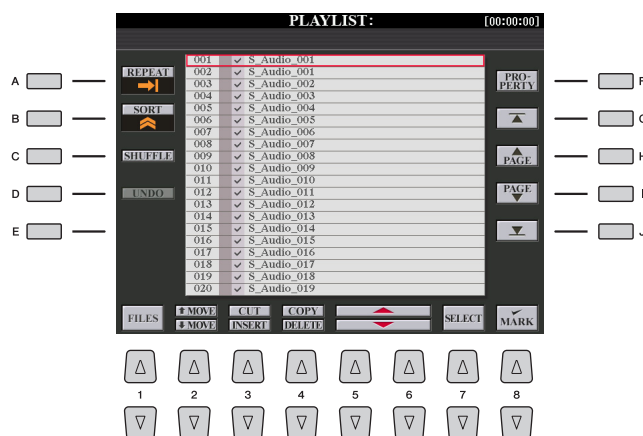

[A]	REPEAT	Determines how the audio files will be played back: All files are played in sequence once through to the end (no repeat). All files are played in sequence repeatedly. One selected file is played repeatedly.
[B]	SORT	Determines whether the audio files are sorted in ascending or descending order by name.
[C]	SHUFFLE	Pressing this button randomly rearranges the order of the files.
[D]	UNDO/REDO	Pressing this button (Undo) cancels the last action made to the Playlist. Pressing it again (Redo) restores the cancelled action. Only one level of Undo/Redo is available.
[F]	PROPERTY	Calls up the Property popup window which shows the file name and path of the audio song at the cursor position.

[G]–[J]		<p>Playlist navigation controls.</p> <p>[G]: Moves cursor/selection to the top of the list.</p> <p>[H]: Moves cursor/selection one page up (when there are multiple pages).</p> <p>[I]: Moves cursor/selection one page down (when there are multiple pages).</p> <p>[J]: Moves cursor/selection to the bottom of the list (just below last entered file).</p>
[1 ▲▼]	FILES	Opens the PLAYLIST FILE display. From this display, you can rename, copy, delete or save the playlists.
[2 ▲▼]	MOVE Up/Down	Use these buttons to move the selected file to another location in the list.
[3 ▲]	CUT	<p>These operations let you copy or cut and paste individual list entries. Keep in mind that these have no effect on the actual audio data, but just entries in the list.</p> <p>Cut and Insert</p> <ol style="list-style-type: none"> 1 Press the [3 ▲] (CUT) button. 2 Select the desired file entry by using the [5 ▲▼] buttons and press the [6 ▲▼] button to actually select it. Then press the [8 ▲] (OK) button. The entry is deleted. 3 Move the cursor to the desired location in the list (with the [5 ▲▼]/[6 ▲▼] buttons) and press the [3 ▼] (INSERT) button. <p>Copy and Insert</p> <ol style="list-style-type: none"> 1 Press the [4 ▲] (COPY) button. 2 Select the desired file entry by using the [5 ▲▼] buttons and press the [6 ▲▼] button to actually select it. Then press the [8 ▲] (OK) button. The entry is copied. 3 Move the cursor to the desired location in the list (with the [5 ▲▼]/[6 ▲▼] buttons) and press the [3 ▼] (INSERT) button.
[3 ▼]	INSERT	
[4 ▲]	COPY	
[4 ▼]	DELETE	Deletes files from the Playlist. Keep in mind that this does not affect the actual audio data, but simply deletes an entry of the file from the list.
[5 ▲▼]/ [6 ▲▼]	Up/Down	Use these buttons to move the cursor in the list. Use the [DATA ENTRY] dial to quickly move the cursor (red border) through the entries and press the [ENTER] button.
[7 ▲▼]	SELECT	Actually selects the file at the cursor position.
[8 ▲▼]	MARK	Adds or removes the checkmark to/from the selected data. Only the checkmarked files will be played. Holding this button adds (or removes) the checkmark to (or from) all files.

Contents

Creating a Set of Favorite Records	91
Editing Records.....	92
• Deleting the Record.....	93
Saving the Records as a Single File (Music Finder File).....	93
• Calling up the Records from a Music Finder file.....	94

Creating a Set of Favorite Records

Even though the Search function lets you efficiently look for Music Finder Records, you may want to create a custom “folder” of your favorite Records—so you can quickly call up the panel settings, Song data and Style data you use frequently.

- 1 Select the desired Record from the MUSIC FINDER display.
- 2 Press the [H] (ADD TO FAVORITE) button, then press the [G] (YES) button to add the selected Record to the FAVORITE page.

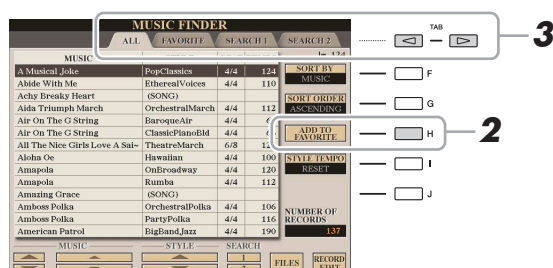

- 3 Select the FAVORITE page by using the TAB [◀][▶] buttons, and check to see if the Record has been added.

As with the ALL page, you can select the Record in the FAVORITE page then start your performance.

Deleting Records from the FAVORITE Page

- 1 Select the Record you want to delete from the FAVORITE page.
- 2 Press the [H] (DELETE FROM FAVORITE) button, then press the [G] (YES) button to actually delete the Record.

Editing Records

You can create your original Record by editing an existing Record. Your edits can be replaced with those of the current Record, or can be saved as a new separate Record.

- 1** Select the desired Record to be edited in the MUSIC FINDER display.
- 2** Press the [8 ▲▼] (RECORD EDIT) button to call up the EDIT display.
- 3** Edit the Record.

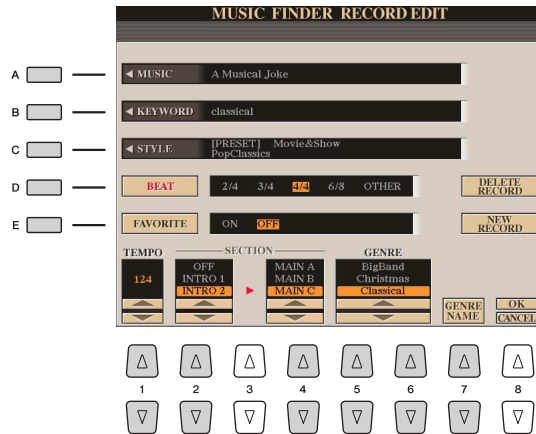

[A]	MUSIC	For entering the music title. Pressing the [A] button calls up the display for entering the music title.
[B]	KEYWORD	For entering the keyword to be used when executing the Search operation. Pressing the [B] button calls up the display for entering the keyword.
[C]	STYLE/SONG/ AUDIO	Changes the Style. Pressing the [C] button calls up the Style Selection display. After selecting the desired Style, press the [EXIT] button to return back to the EDIT display. For SONG or AUDIO Records, this field cannot be edited.
[D]	BEAT	Changes the beat (time signature) of the Record for search purposes. For SONG or AUDIO Records, this field cannot be edited. NOTE Keep in mind that the Beat setting made here is only for the Music Finder search function; this does not affect the actual Beat setting of the Style itself.
[E]	FAVORITE	Selects whether the edited Record is added to the FAVORITE page or not.
[1 ▲▼]	TEMPO	Changes the Tempo. For SONG or AUDIO Records, this field cannot be edited.
[2 ▲▼]	SECTIONS	Selects the Style sections that are called up as a set when the Record is selected. You can start the Record with the section selected by the [2 ▲▼] buttons. When the section finishes, Style playback automatically shifts to the section selected by the [4 ▲▼] buttons. For SONG or AUDIO Records, this field cannot be edited.
[4 ▲▼]		
[5 ▲▼]/ [6 ▲▼]	GENRE	Selects the desired genre.
[7 ▲▼]	GENRE NAME	Creates a new genre.

To cancel and quit the Edit operation, press the [8 ▼] (CANCEL) button.

4 Save the edited Record.

When creating a new Record

Press the [J] (NEW RECORD) button. The Record is added to the ALL page.

When overwriting an existing Record

Press the [8 ▲] (OK) button.

Deleting the Record

By executing the Delete operation, you can delete the desired Record from all pages (ALL, FAVORITE and SEARCH 1/2).

1 Select the Record to be deleted from the MUSIC FINDER display.

2 Press the [8 ▲▼] (RECORD EDIT) button to call up the EDIT display.

3 Press the [I] (DELETE RECORD) button.

To cancel the Delete operation and return to the MUSIC FINDER display in Step 1, press [G] (NO); to return to the EDIT display in Step 2, press [H] (CANCEL).

4 Press the [F] (YES) button to delete the current Record.

Saving the Records as a Single File (Music Finder File)

The Music Finder feature handles all the Records including the presets and additionally created Records as a single Music Finder file. Keep in mind that individual Records (panel settings, Song, audio and Style files) cannot be handled as separate files.

1 Press the [7 ▲▼] (FILES) button in the MUSIC FINDER display to call up the File Selection display.

2 Press the TAB [◀][▶] buttons to select the location for saving (USER/HD/USB).

3 Press the [6 ▼] (SAVE) button.

4 Press the [8 ▲] (OK) button to actually save the file.

All Records are saved together as a single Music Finder file.

Calling up the Records from a Music Finder file

By selecting a Music Finder file, you can recall the Records saved to the User, Hard disk or USB drive as a file.

- 1** Press the [7 ▲▼] (FILES) button in the MUSIC FINDER display to call up the File Selection display.
- 2** Use the TAB [◀][▶] buttons to select the location to which the file is saved.
- 3** Press the [A]–[J] buttons to select the desired Music Finder file.

A message appears, prompting you to select one of the following options.

[F]	REPLACE	All Music Finder Records currently in the instrument are deleted and replaced with the Records of the selected file. NOTICE Selecting “REPLACE” automatically deletes all your original Records from internal memory. Make sure that all important data has been archived to another location beforehand.
[G]	APPEND	The Records called up are added to the Records currently in the instrument.
[H]	CANCEL	Cancels the file selection operation.

Contents

Editing a Registration Memory	95
Disabling Recall of Specific Items (Freeze)	96
Calling Up Registration Memory Numbers in Order (Registration Sequence)	97
• Saving the Registration Sequence Settings	98
• Using the Registration Sequence	99

Editing a Registration Memory

You can edit (rename and delete) each of Registration Memories contained in the Bank.

- 1 Select the Registration Memory Bank containing the Registration Memory to be edited.**
Press the REGISTRATION BANK [+] / [-] buttons simultaneously to call up the Registration Bank Selection display, then press one of the [A]–[J] buttons to select the desired Bank.
- 2 Make sure the MENU 1 is shown at the bottom right corner of the display.**
- 3 Press the [7 ▼] (EDIT) button to call up the REGISTRATION EDIT display.**
- 4 Select a particular Registration Memory to be edited by pressing any of the [A]–[D] and [F]–[I] buttons.**
- 5 Press the [1 ▼] button to rename or the [5 ▼] button to delete the selected Registration Memory.**

For details on the Rename and Delete operations, refer to the Basic Operations of the Owner's Manual.



- 6 Save the current Bank containing the edited Registration Memories.**

Press the [8 ▲] button to call up the Registration Memory Selection display. Change MENU 1 to MENU 2 by pressing the [8 ▼] button, then press the [6 ▼] (SAVE) button to execute the Save operation.

Disabling Recall of Specific Items (Freeze)

Registration Memory lets you recall all the panel setups you made with a single button press. However, there may be times that you want certain items to remain the same, even when switching Registration Memory setups. When you want to switch the Voice settings but still maintain the Style settings, for example, you can “freeze” only the Style settings and have those Style settings remain, even when you select another Registration Memory number.

1 Call up the operation display.

[FUNCTION] → [E] REGIST SEQUENCE/FREEZE/VOICE SET → TAB [◀][▶] FREEZE

2 Use the [2 ▲▼]–[7 ▲▼] buttons to select the desired item, then use the [8 ▲▼] buttons to enter or remove the checkmark.

Items having checkmarks will be frozen when [FREEZE] is turned on.



3 Press the [EXIT] button to exit from the operation display.

4 Press the [FREEZE] button on the panel to turn the Freeze function on.

With this operation, you can “freeze” or maintain checkmarked items, even when you select another Registration Memory number. To turn off the Freeze function, press the [FREEZE] button again.

NOTICE

Settings in the REGISTRATION FREEZE display are automatically saved to the instrument when you exit from this display. However, if you turn the power off without exiting from this display, the settings will be lost.

Calling Up Registration Memory Numbers in Order (Registration Sequence)

As convenient as the Registration Memory buttons are, there may be times during a performance when you want to even more easily switch between settings. The convenient Registration Sequence function lets you call up the eight setups in any order you specify, by simply using the TAB [◀][▶] buttons (in the Main display) or the pedal as you play.

1 If you intend to use a pedal or pedals to switch the Registration Memory number, connect the optional pedals to the appropriate FOOT PEDAL jacks.

For instructions, refer to Chapter 11 of the Owner's Manual.

2 In the REGISTRATION BANK display, select the desired Bank to be programmed.

3 Call up the operation display.

[FUNCTION] → [E] REGIST SEQUENCE/FREEZE/VOICE SET → TAB [◀][▶] REGISTRATION SEQUENCE

4 If you use a pedal, specify here how the pedal will be used—to advance or to reverse through the sequence.

Use the [C] or [D] button to select the pedal for advancing or reversing through the Registration Sequence. For example, if two pedals are connected, Pedal 1 is used for advancing while Pedal 2 is used for reversing. Note that the pedal settings here (other than OFF) will take priority over the settings in the FOOT PEDAL display (page 133). If you want to use the pedal for a function other than Registration Sequence, make sure to set this to OFF.

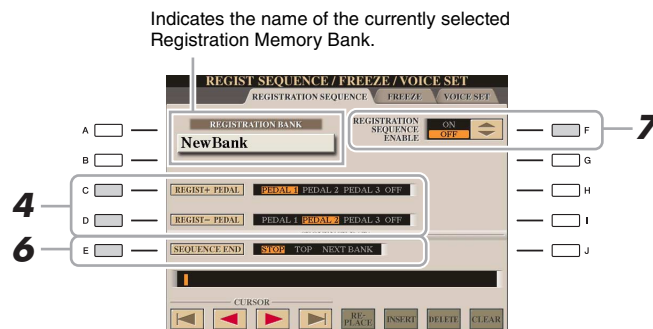

5 Program the Sequence order, from left to right.

Press one of the REGISTRATION MEMORY [1]–[8] buttons on the panel, then press the [6 ▲▼] (INSERT) button to input the number.

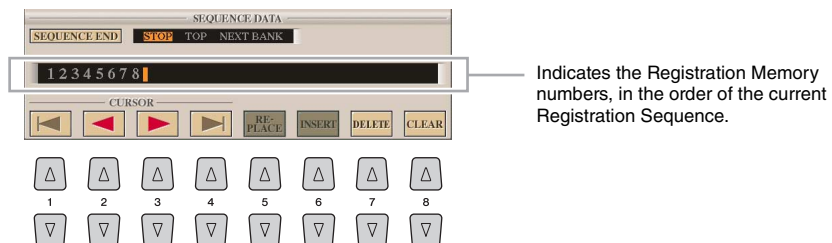

[1 ▲▼]- [4 ▲▼]	CURSOR	Moves the cursor.
[5 ▲▼]	REPLACE	Replaces the number at the cursor position with the currently selected Registration Memory number.
[6 ▲▼]	INSERT	Inserts the number of the currently selected Registration Memory number to the cursor position.
[7 ▲▼]	DELETE	Deletes the number at the cursor position.
[8 ▲▼]	CLEAR	Deletes all numbers in the sequence.

6 Use the [E] (SEQUENCE END) button to determine how Registration Sequence behaves when reaching the end of the sequence.

- **STOP**Pressing the TAB [▶] button or the “advance” pedal has no effect. The sequence is “stopped.”
- **TOP**The sequence starts again at the beginning.
- **NEXT BANK**The sequence automatically moves to the beginning of the next Registration Memory Bank in the same folder.

7 Press the [F] (REGISTRATION SEQUENCE ENABLE) button to turn the Registration Sequence function on.

8 Press the [EXIT] button to exit from the operation display.

After the confirmation message appears, press the [G] (YES) button to store the Registration Sequence program temporarily.

Saving the Registration Sequence Settings

The settings for the Sequence order and how Registration Sequence behaves when reaching the end of the sequence (SEQUENCE END) are included as part of the Registration Memory Bank file. To store your newly programmed Registration Sequence, save the current Registration Memory Bank file.

NOTICE

Keep in mind that all Registration Sequence data is lost when changing Registration Memory Banks, unless you've saved it with the Registration Memory Bank file.

1 Press the REGIST BANK [+] and [-] buttons simultaneously to call up the REGISTRATION BANK Selection display.

2 Make sure the MENU 2 is shown at the bottom right corner of the display.

3 Press the [6 ▼] button to save the Bank file.

Using the Registration Sequence

- 1** Select the desired Registration Bank.
- 2** At the upper right of the Main display, confirm the Registration Sequence.



The Registration Sequence is indicated at the upper right of the Main display, letting you confirm the currently selected numbers.

- 3** Press the TAB [◀] or [▶] button, or press the Foot Pedal to select the first Registration Memory number.

The box appears around the left-most number, indicating that this Registration Memory number is currently selected.

- 4** Use the TAB buttons or Foot Pedal during your keyboard performance.

To return to the status in which no Registration Memory number is selected, press the [◀] and [▶] buttons simultaneously in the Main display.

NOTE

The pedal can be used for Registration Sequence no matter which display is called up (except for the REGIST SEQUENCE display).

8

Microphone

– Adding Harmony Vocals and Synth Vocoder to Your Singing –

Contents

Vocal Harmony and Talk Setting	100
Making and Saving the Microphone Settings (Vocal/Talk).....	101
• Saving the Microphone Settings.....	101
• VOCAL Page.....	102
• TALK Page	103
Setting and Editing Vocal Harmony Types	104
• Setting up the Vocal Harmony Control Parameters.....	104
• Editing the Vocal Harmony Types.....	106
Editing the Synth Vocoder Types	111
• Editing the Overview Tab Parameters	112
• Editing the Detail Tab Parameters.....	114

Vocal Harmony and Talk Setting



- ① **[VOCAL HARMONY] button**
Turns on or off the Vocal Harmony.
- ② **[VOCAL EFFECT] button**
Turns on or off the Vocal Effect which can be set on the display called up via [VH TYPE SELECT]→ [8 ▼] (EDIT). For details, refer to [page 104](#).
- ③ **[TALK] button**
Switches the microphone setup between the Vocal setup (used during microphone performance) and Talk setup (used during talk or between a certain performance and the next performance). When set to ON, only the Talk settings are active. When set to OFF, only the Vocal Harmony settings are active.
- ④ **[VH TYPE SELECT] button**
For selecting the desired Vocal Harmony type.
- ⑤ **[MIC SETTING] button**
For setting various microphone-related parameters, for Vocal Harmony and Talk independently.

Making and Saving the Microphone Settings (Vocal/Talk)

This section explains how to make and save the detailed settings for the microphone.

- 1** Connect the microphone, press the [MIC SETTING/VOCAL HARMONY] button to call up the operation display, then press the [F] button to set the MIC to ON.

This lets you talk into the microphone and hear the changes made while setting the parameters.

- 2** Select the desired page, VOCAL or TALK, by using the TAB [◀][▶] buttons.

NOTE

The settings on the TALK page are microphone settings that are active when the Talk function is on.



- 3** Use the [A]–[E] buttons to select the specific row (or group) of parameters to be adjusted.

- 4** Set the value of specific parameters in the row by using the [1 ▲▼]–[6 ▲▼] buttons.

For information on each parameter, see [pages 102–103](#).

NOTICE

After setting, go to the Mic Setting Memory display by pressing the [H] (USER MEMORY) button and save the settings (see [page 102](#)). The settings will be lost if you exit from this display or turn the power to the instrument off without executing the Save operation.

Saving the Microphone Settings

All the settings (VOCAL/TALK pages) are saved together as a single file. Up to ten files can be saved.

- 1** On the MIC SETTING display (in step 3 above), press the [H] (USER MEMORY) button.
- 2** Press the [6 ▼] (SAVE) button to save the file to USER.

For details on the naming and deleting procedures, refer to the Basic Operations section in the Owner's Manual.

NOTE

The microphone setting file can be saved only to internal USER drive. If you want to save this setting USB flash memory, save the User Effect file on the display called up via [FUNCTION] → [H] (UTILITY) → SYSTEM RESET → [H] (USER EFFECT).

Calling Up the Microphone Settings Saved to USER

- 1** [MIC SETTING] button → [H] USER MEMORY
- 2** Press the [A]–[J] buttons to select the desired setting file.

3-BAND EQ (selected by [A]/[B] buttons)

EQ (Equalizer) is a processor that divides the frequency spectrum into multiple bands which can be boosted or cut as required to tailor the overall frequency response. This instrument features a high-grade three-band (LOW, MID and HIGH) digital equalizer function for the microphone sound.

[1 ▲▼]/ [3 ▲▼]/ [5 ▲▼]	Hz	Adjusts the center frequency of the corresponding band.
[2 ▲▼]/ [4 ▲▼]/ [6 ▲▼]	dB	Boosts or cuts the level of the corresponding band by up to 12 dB.

NOISE GATE (selected by [C]/[D] buttons)

This effect mutes the input signal when the input from the microphone falls below a specified level. This effectively cuts off extraneous noise, allowing the desired signal (vocal, etc.) to pass.

[1 ▲▼]	SW (Switch)	Turns the Noise Gate on or off.
[2 ▲▼]	TH. (Threshold)	Adjusts the input level at which the gate begins to open.

COMPRESSOR (selected by [C]/[D] buttons)

This effect holds down the output when the input signal from the microphone exceeds a specified level. This is especially useful for smoothing out vocals that have widely varying dynamics. It effectively “compresses” the signal, making soft parts louder and loud parts softer. For a maximum compression effect, set RATIO to a high setting and adjust the OUT parameter for optimum volume.

[3 ▲▼]	SW (Switch)	Turns the Compressor on or off.
[4 ▲▼]	TH. (Threshold)	Adjusts the input level above which the Compressor is applied.
[5 ▲▼]	RATIO	Adjusts the compression ratio. Higher ratios result in a more compressed sound, with a reduced dynamic range.
[6 ▲▼]	OUT	Adjusts the final output level.

PITCH DETECT (selected by [E] button)

Determines how this instrument detects or recognizes the pitch of the microphone sound you input during performance.

[1 ▲▼]/ [2 ▲▼]	VOCAL TYPE	<p>Set this to obtain the most natural vocal harmony, depending on your voice.</p> <p>LOW: Setting for lower voices. This setting is also appropriate for growling and shouting.</p> <p>MID: Setting for mid-range voices.</p> <p>HIGH: Setting for higher voices. This setting is also appropriate for singing close to the microphone.</p> <p>FULL: Setting for vocalists having a wide range, from low to high.</p>
[3 ▲▼]/ [4 ▲▼]	BACKGROUND NOISE CUT	THRU, 200Hz, 300Hz, 400Hz, 500Hz: This allows you to filter out low noises that would interfere with the Vocal Harmony effect. A setting of “THRU” turns the noise filter off.
[5 ▲▼]/ [6 ▲▼]	SPEED	<p>1 (SLOW) – 4 (NORMAL) – 15 (FAST): Adjusts the response of the Vocal Harmony effect, or how quickly harmonies are generated in response to your voice.</p> <p> NOTE</p> <p>When the Vocal Harmony's Pitch Detect Speed of one or both parts of Lead and Harm. are set to “as Mic Setting” in the Detail tab (page 110), this parameter is effective. In other settings, the setting of the Vocal Harmony's Pitch Detect Speed is effective.</p>

TALK Page

The settings here are for your speech or announcements (NOT your singing performance), and are active when the TALK (page 100) is set to ON. All indications and parameters (with the exception of TALK MIXING below) are the same as in the VOCAL page. However, the settings are independent from those in the VOCAL page.



TALK MIXING (selected by [E] button)

[1 ▲▼]	VOLUME	Determines the output volume of the microphone sound.
[2 ▲▼]	PAN	Determines the stereo pan position of the microphone sound.
[3 ▲▼]	REVERB DEPTH	Determines the depth of the reverb effects applied to the microphone sound.
[4 ▲▼]	CHORUS DEPTH	Determines the depth of the chorus effects applied to the microphone sound.
[5 ▲▼]/ [6 ▲▼]	REDUCTION LEVEL	Determines the amount of reduction to be applied to the overall sound (excepting the microphone input)—allowing you to effectively adjust the balance between your voice and the overall instrument sound.

Setting and Editing Vocal Harmony Types

Setting up the Vocal Harmony Control Parameters

You can set which part controls the Vocal Harmony regardless of the current Vocal Harmony Type.

- 1 Press the [VH TYPE SELECT] button to call up the Vocal Harmony Type Selection display.



NOTE

Check that the microphone is properly connected (Owner's Manual, chapter 8) and the settings (Reference Manual, page 101) are adjusted correctly before setting the Vocal Harmony Control parameters here.

- 2 Press the [8 ▲] (SETUP) button to call up the Setup display, then set the value by using the [2 ▲▼]–[5 ▲▼] and [7 ▲▼] buttons.

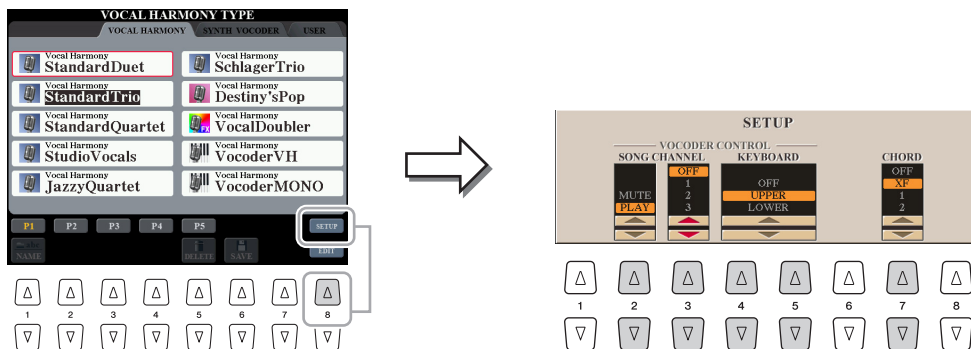

For information on each parameter, see [page 105](#).



- 3 After you finish setting the value, press the [EXIT] button to close the Setup display.

NEXT PAGE

Setup Parameters

[2 ▲▼]– [5 ▲▼]	VOCODER CONTROL	The Vocal Harmony effect in the Vocoder and Vocoder-Mono modes is controlled by the notes you play on the keyboard and/or Song data.
[2 ▲▼]	SONG CHANNEL MUTE/ PLAY	When set to “MUTE,” the channel selected below (to control Harmony) is muted (turned off) during Song playback. This enables you to sing a song with harmony, even without backing or accompaniment.
[3 ▲▼]	SONG CHANNEL OFF/1–16	When set to OFF, Song playback does not affect the Vocal Harmony. When set to one of the values 1–16, note data (played from a Song on this instrument or external MIDI sequencer) contained on the corresponding channel is used to control the harmony.
[4 ▲▼] / [5 ▲▼]	KEYBOARD	<p>OFF: Keyboard performance does not affect the Vocal Harmony.</p> <p>UPPER: Notes played to the right of the Split Point control the harmony.</p> <p>LOWER: Notes played to the left of the Split Point control the harmony.</p> <p> NOTE</p> <p>The separate point of the Keyboard settings (OFF/UPPER/LOWER) is Split Point (L).</p> <p> NOTE</p> <p>When the settings of both keyboard performance and Song data are applied, those settings are merged to control the harmony.</p>
[7 ▲▼]	CHORD	<p>In Chordal mode, the following parameters determine which data in a Song is used for chord detection.</p> <p>OFF: Chords are not detected from the Song data.</p> <p>XF: Chords of XF format are used for the Vocal Harmony.</p> <p>1–16: Chords are detected from note data in the specified Song channel.</p> <p> NOTE</p> <p>The Vocal Harmony may not work properly regardless of the setting here depending on the Song data. This occurs when the selected Song contains no chord data or has insufficient note data for chord detection.</p>

Editing the Vocal Harmony Types

This section explains briefly how to create your own Vocal Harmony types, and lists the detailed parameters for editing. A sum total of sixty types can be created and saved.

- 1 Press the [VH TYPE SELECT] button to call up the Vocal Harmony Type Selection display.



- 2 Select a Vocal Harmony type to be edited by using the [A]–[J] buttons.

To call up the other display pages for further selections, press one of the [1 ▲]–[5 ▲] buttons.

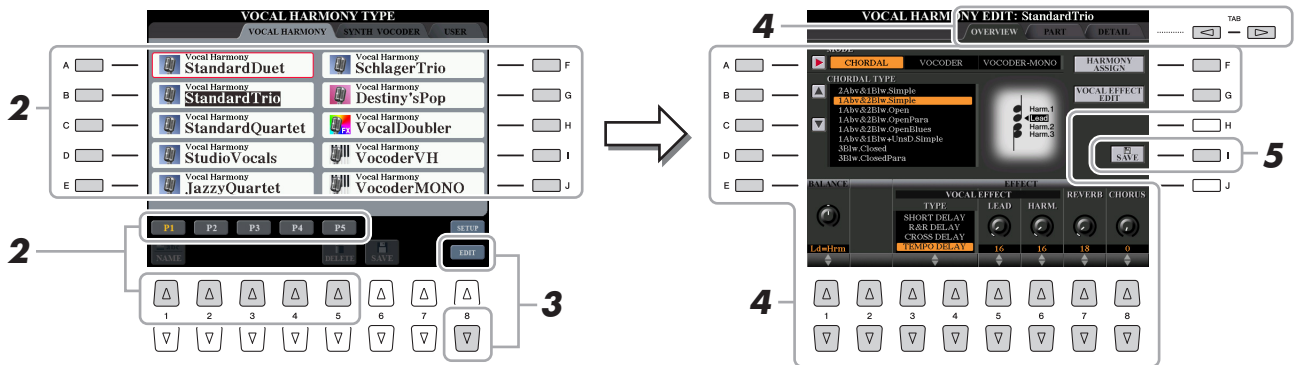

- 3 Press the [8 ▼] (EDIT) button to call up the Vocal Harmony Edit display.

- 4 Use the TAB [◀][▶] buttons to call up the desired tab, then edit the Vocal Harmony by using [A]–[G] buttons and [1 ▲▼]–[8 ▲▼] buttons.

There are three tabs in the Vocal Harmony Edit display; refer to [pages 107–110](#) for editing each tab.

- **OVERVIEW**.....Edits basic parameters for Vocal Harmony type, including Mode, Chordal Type and Vocal Effect, etc.
- **PART**.....Adjusts volume and panning, etc. for each of the harmony notes (Harm.1, 2, 3 and Lead).
- **DETAIL**.....Detailed editing for Vocal Harmony type.

- 5 Press the [I] (SAVE) button to save your edited Vocal Harmony type.

For details on the Save operation, refer to the Owner's Manual, Basic Operations.

NOTICE

The settings here will be lost if you change to another Vocal Harmony type or you turn the power off without executing the Save operation.

NOTE

The edited Vocal Harmony Type can be saved only to internal USER drive as a file. If you want to save this to USB flash memory, save the User Effect file on the display called up via [FUNCTION] → [H] (UTILITY) → SYSTEM RESET → [H] (USER EFFECT).

■ Editing the Overview Tab Parameters



1 Set the value by using the [A]–[C] buttons, [1 ▲▼] and [3 ▲▼]–[8 ▲▼] buttons.
For information on each parameter, see [page 108](#).

2 Press the [F] (HARMONY ASSIGN) button to set how the Vocal Harmony is applied to your singing voice.
For information on each parameter, see [page 108](#).

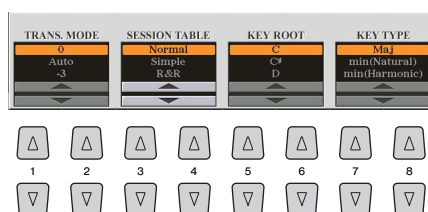

3 Press the [G] (VOCAL EFFECT EDIT) button to edit the Vocal Effect.

On the display called up via this operation, use the [3 ▲▼]–[5 ▲▼] buttons to select the parameter then use the [6 ▲▼]–[7 ▲▼] buttons to set the value. If necessary, you can change the Effect Type from the one selected in Step 1 also on this display via the [1 ▲▼]/[2 ▲▼] buttons.
For information on each parameter, refer to the Data List (Vocal Harmony Parameter List) on the website.

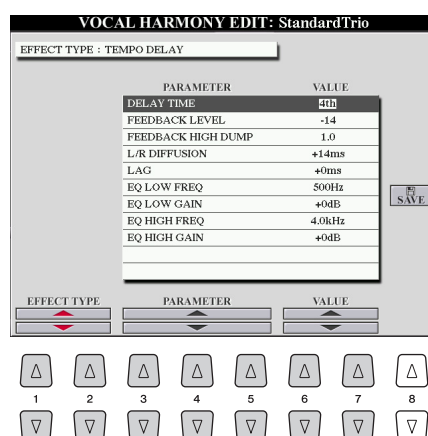

Overview Tab Parameters

[A]	MODE	Determines the mode of the Vocal Harmony effect: Chordal, Vocoder or Vocoder-Mono. Chordal is for conventional vocal harmonies, while Vocoder and Vocoder-Mono are for Vocoder effects. (Vocoder-Mono is for single-note melodies.) When Vocoder or Vocoder-Mono is selected, the Chordal Type parameter below is not available.
[B]/[C]	CHORDAL TYPE	Determines the particular notes and voicings used for generating the vocal harmonies. The harmony and lead notes are also shown as notation in the display. For a list of the Chordal Types, refer to the Data List (Vocal Harmony Parameter List) on the website.
[1 ▲▼]	BALANCE	Lets you set the balance between the lead vocal (your own voice) and Vocal Harmony. Raising this value increases the volume of the Vocal Harmony and decreases that of the lead vocal. When this is set to L<H63 (L: Lead Vocal, H: Vocal Harmony), only the Vocal Harmony is output; when it is set to L63>H, only the lead vocal is output.
[3 ▲▼]– [6 ▲▼]	VOCAL EFFECT	Determines the Vocal Effect type and the amount of the effect applied to the lead and harmony vocal sounds.
[3 ▲▼] –[4 ▲▼]	TYPE	Determines the specific Vocal Effect type applied to the lead and harmony vocal sounds. A wide range of reverb, delay, modulation, distortion and other special effects are available. For a list of the effect types, refer to the Data List (Vocal Harmony Parameter List) on the website.
[5 ▲▼]	LEAD	Determines the amount of Vocal Effect that is applied to the lead vocal sound.
[6 ▲▼]	HARM. (Harmony)	Determines the amount of Vocal Effect that is applied to the harmony vocal sound.
[7 ▲▼]	REVERB	Determines the amount of reverb applied to the overall Vocal Harmony sound, both lead and harmony.
[8 ▲▼]	CHORUS	Determines the amount of chorus effect applied to the overall Vocal Harmony sound, both lead and harmony.

HARMONY ASSIGN

For detailed information on each parameter, refer to the Data List (Vocal Harmony Parameter List) on the website.

[1 ▲▼]/ [2 ▲▼]	TRANS. (TRANSPOSE) MODE	Determines the amount by which the harmony parts are transposed. A setting of “0” results in no transposition, while the “Auto” setting results in automatic transposition. When the mode is set to Vocoder or Vocoder-Mono, this parameter is available. Settings: 0, Auto, -3 – +3
[3 ▲▼]/ [4 ▲▼]	SESSION TABLE	Determines how the harmonies will be voiced, or what type of chord will be used in creating the harmonies, according to different musical styles. This parameter is available only when the mode is set to Chordal and the type is set to something other than ScaleDiatonic or Parallel. Settings: Normal, Simple, R&R, UrbanA, UrbanB, Blues7, UrbanC
[5 ▲▼]/ [6 ▲▼]	KEY ROOT	Determines the root key for the transposition. Use this in combination with Key Type below to enable modal scale harmony transposition. When the Chordal Type parameter is set to ScaleDiatonic, this parameter is available. Settings: C, C#, D, D#, E, F, F#, G, G#, A, A#, B
[7 ▲▼]/ [8 ▲▼]	KEY TYPE	Determines the scale type for the transposition. Use this in combination with Key Root above to enable modal scale harmony transposition. When the Chordal Type parameter is set to ScaleDiatonic, this parameter is available. Settings: Maj, Min (Natural), Min (Harmonic)

■ Editing the Part Tab Parameters

The parameters are arranged in a matrix.

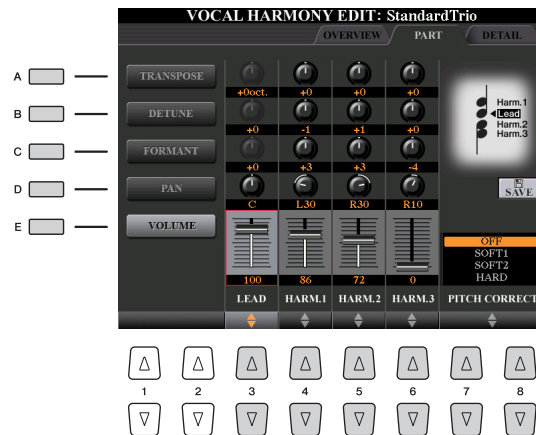

Use the [A]–[E] buttons to select the desired parameter, then edit each of the Vocal Parts including the Harmony notes (Harm.1, 2, 3) and Lead voice (your own voice) via the [3 ▲▼]–[8 ▲▼] buttons.

For information on each parameter, see below.

● TRANSPOSE (selected by [A] button)

Determines the pitch transposition for each part. The range for all parts is the same; however, the lead vocal sound can only be adjusted in octaves. When the Chordal Type is set to ScaleDiatonic, this parameter changes to Degree. When Pitch Correct is set to Off, the Lead part is not available. When the Vocoder or Vocoder-Mono mode is selected, the Harmony parts are not available.

TRANSPOSE Settings

Lead: -3 octaves – +3 octaves

Harmony 1, 2, 3: -36 semitones – +36 semitones

DEGREE Settings

Lead: -3 octaves – +3 octaves

Harmony 1, 2, 3: -3 octaves (-22 scale degrees) – Unison – +3 octaves (+22 scale degrees)

● DETUNE (selected by [B] button)

Determines the fine pitch setting for each part. Adjust this to produce a warm chorusing effect, or to achieve a natural, less-than-perfect vocal sound. When Pitch Correct is set to Off, the Lead part is not available.

Settings: -50 cents – +50 cents

● FORMANT (selected by [C] button)

Determines the formant setting for each part. This parameter can be used to finely change the character of the vocal sound. The higher the value, the more “feminine” the harmony voice becomes. The lower the value, the more “masculine” the voice. When Pitch Correct is set to Off, the Lead part is not available.

Settings: -62 – +62

● PAN (selected by [D] button)

Determines the pan position setting for each part. Setting each vocal part to a different pan position, with the lead vocal at center, for example, results in a naturally wide stereo sound.

Settings: L63 (Left) – C (Center) – R63 (Right)

● VOLUME (selected by [E] button)

Determines the volume setting for each part. Use this to adjust the relative level balance among the vocal parts.

Settings: 0–127

● **PITCH CORRECT MODE** (set by [7 ▲▼]–[8 ▲▼] buttons)

Determines how Pitch Correct affects your voice. For information on each parameter, refer to the Data List (Vocal Harmony Parameter List) on the website.

Settings: OFF, SOFT 1, SOFT 2, HARD

■ **Editing the Detail Tab Parameters**

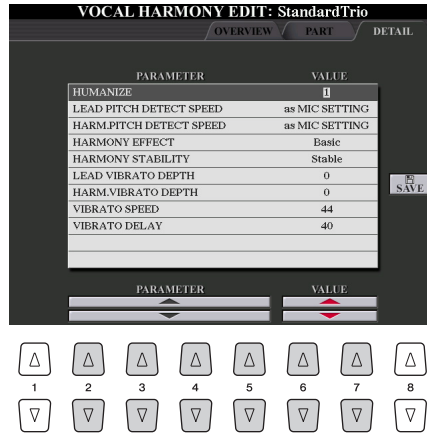

Use the [2 ▲▼]–[5 ▲▼] buttons to select the desired parameter, then set the value of the selected parameter by using the [6 ▲▼]/[7 ▲▼] buttons.

For information on each parameter, refer to the Data List (Vocal Harmony Parameter List) on the website.

Editing the Synth Vocoder Types

This section explains how to create your own Synth Vocoder types, and lists the detailed parameters for editing. A sum total of sixty types (Synth Vocoder and Vocal Harmony types) can be created and saved.

NOTE
For information on "Editing the Vocal Harmony Types," refer to [page 106](#).

1 Press the [VH TYPE SELECT] button to call up the Vocal Harmony Type Selection display.

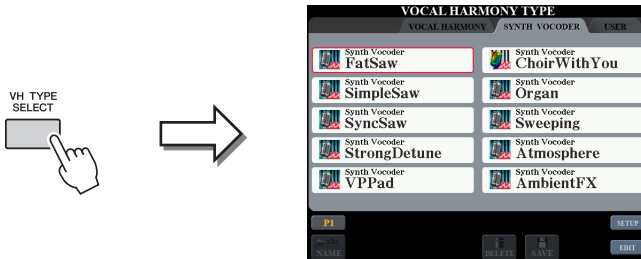

2 Use the TAB [◀][▶] buttons to select the Synth Vocoder tab.

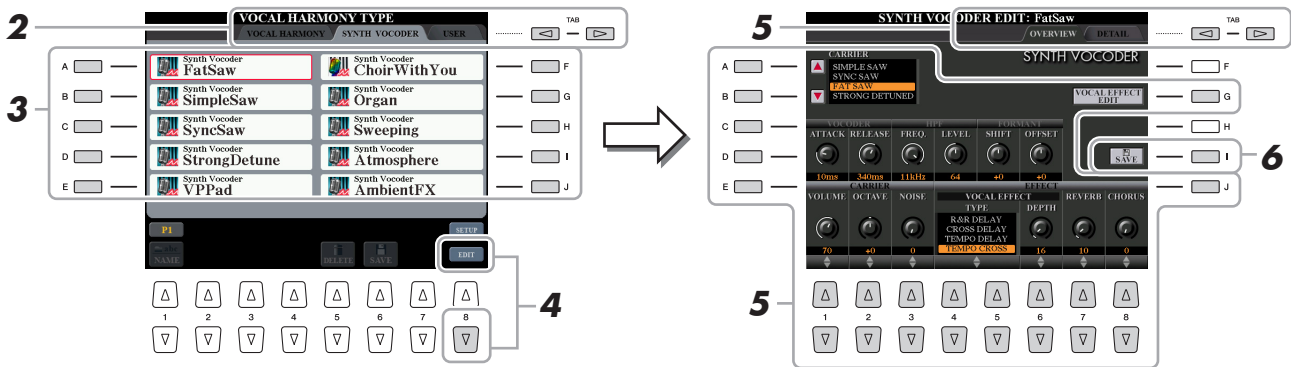

3 Select a Synth Vocoder type to be edited by using the [A]–[J] buttons.

4 Press the [8 ▼] (EDIT) button to call up the Synth Vocoder Edit display.

5 Use the TAB [◀][▶] buttons to call up the desired tab, then edit the Synth Vocoder by using [A]–[E], [G] and [J] buttons and [1 ▲▼]–[8 ▲▼] buttons or sliders.

There are two tabs in the Synth Vocoder Edit display; refer to [pages 112–114](#) for editing each tab.

NOTICE
The settings here will be lost if you change to another Synth Vocoder type or you turn the power off without executing the save operation.

- **OVERVIEW**..... Edits basic parameters for Synth Vocoder type, including Carrier, Vocoder Attack/Release and HPF (High Pass Filter), etc.
- **DETAIL**..... Detailed editing for Synth Vocoder type.

6 Press the [I] (SAVE) button to save your edited Synth Vocoder type.

Editing the Overview Tab Parameters



1 Use the [A]–[E] (or [J]) buttons to select the parameter to be adjusted, then set the value by using the [1 ▲▼]–[8 ▲▼] buttons or sliders.

For information on each parameter, see [page 113](#).

2 Press the [G] (VOCAL EFFECT EDIT) button to edit the Vocal Effect.

Use the [1 ▲▼]–[5 ▲▼] buttons to select the desired effect type and parameter, then set the value of the selected parameter by using the [6 ▲▼]/[7 ▲▼] buttons.

For information on each parameter, refer to the Data List on the website.

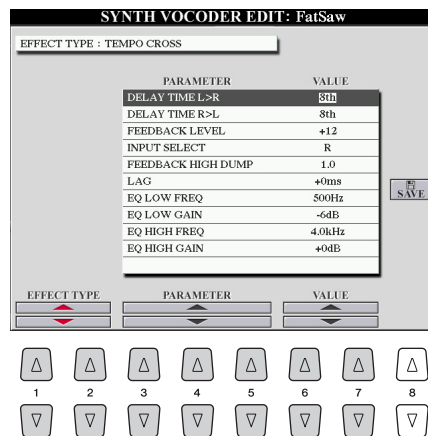

NEXT PAGE

CARRIER (set by [A]/[B] buttons)

Selects the musical instrument sound used as the source (Carrier) for the Synth Vocoder. (The Carrier serves as the basic sound over which the vocal characteristics are applied.)

VOCODER parameters (selected by [C]/[D] buttons)

[1 ▲▼]	ATTACK	Determines the attack time of the Synth Vocoder sound. The higher the value, the slower the attack. Settings: 1ms – 200ms
[2 ▲▼]	RELEASE	Determines the release time of the Synth Vocoder sound. The higher the value, the slower the decay. Settings: 10ms – 3000ms

HPF (High Pass Filter) parameters (selected by [C]/[D] buttons)

[3 ▲▼]	FREQ. (Frequency)	Determines the HPF cutoff frequency for the microphone input sound. Setting this to a low value results in a minimally processed input sound—in other words, close to the original. Setting this to higher values emphasizes the higher frequency consonant and sibilant sounds (making words easier to understand). Settings: Thru, 500Hz – 16kHz
[4 ▲▼]	LEVEL	Determines the level of the microphone sound output from the HPF. Settings: 0 – 127

FORMANT parameters (selected by [C]/[D] buttons)

[5 ▲▼]	SHIFT	Determines the amount (in BPF) by which the cutoff frequency value of the BPFs (for the Inst Input) is shifted. This parameter can be used to change the character of the Vocoder sound. Settings: -2, -1, +0, +1, +2
[6 ▲▼]	OFFSET	Adjusts the cutoff frequencies of all BPFs (for the Inst Input) finely. This parameter can be used to finely change the character of the Vocoder sound. Settings: -63 – +0 – +63

CARRIER parameters (selected by [E]/[J] buttons)

[1 ▲▼]	VOLUME	Determines the level of the Carrier for the Synth Vocoder sound. Settings: 0–127
[2 ▲▼]	OCTAVE	Determines the octave setting of the Carrier for the Synth Vocoder sound. Settings: -2 – +2
[3 ▲▼]	NOISE	Determines the noise level which is input to the Synth Vocoder. This can be used to emphasize sibilant and plosive sounds, and make the speech-like characteristics more pronounced. Settings: 0 – 127

EFFECT parameters (selected by [E]/[J] buttons)

[4 ▲▼]/ [5 ▲▼]	TYPE	Determines the specific type of effect applied to the lead Synth Vocoder sound. A wide range of reverb, delay, modulation, distortion and other special effects are available. You can edit the vocal effect by pressing the [G] (VOCAL EFFECT EDIT) button (step 2 on page 112). For a list of the effect types, refer to the Data List on the website.
[6 ▲▼]	DEPTH	Determines the amount of effect applied to the overall Synth Vocoder sound.
[7 ▲▼]	REVERB	Determines the amount of reverb applied to the overall Synth Vocoder sound.
[8 ▲▼]	CHORUS	Determines the amount of chorus effect applied to the overall Synth Vocoder sound.

Editing the Detail Tab Parameters

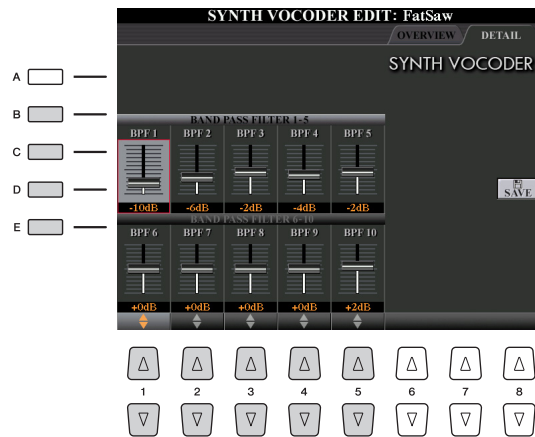

Use the [B]–[E] buttons to select the **BAND PASS FILTER 1–5** or **6–10**, then set the value by using the [1 ▲▼]–[5 ▲▼] buttons or sliders.

NOTE

Feedback (howling) may result depending on the setup settings. Be careful especially when you increase values.

BAND PASS FILTER 1–10 parameters

Determines each output gain of the BPF 1 – 10 for the Inst Input (keyboard performance sound). The BPF 1 corresponds to the lowest Formant while the BPF 10 corresponds to the highest Formant.

Settings: -18dB – +18dB

Contents

Editing VOL/VOICE Parameters	115
Editing FILTER Parameters	116
Editing TUNE Parameters	117
Editing EFFECT Parameters	118
• Adjusting the Effect Depth for Each Part	118
• Selecting an Effect Type for Each Block	118
• Editing and Saving Your Original Effect Type	120
Editing EQ Parameters	122
• Editing and Saving Your Original Master EQ Type	123
Editing Master Compressor Settings	123
Line Out Settings	124
Block Diagram	125

Regarding the Mixing Console, the Reference Manual covers detailed descriptions of each parameter while the Owner’s Manual covers the basic instructions including the Save operation. You can edit various parameters for the Parts called up via the [MIXING CONSOLE] button, then save your edits for future recall.

Editing VOL/VOICE Parameters



[C]/[H]	VOICE	<p>Allows you to re-select the Voices for each part.</p> <p>NOTE</p> <ul style="list-style-type: none"> Note the following operation limitations. For each Style part, you can select the Voices for recording (pages 34 and 35). For each Style or Song channel, you cannot select Voices in the User drive. For each Multi Pad, you cannot change the Voice. When a GM Song is selected, only a Drum Kit Voice can be selected for channel 10 (in the SONG CH9-16 page). <p>NOTE</p> <p>For a Style or Song channel, calling up a rhythm/percussion Voice (Drum Kit, etc.) will replace the channel settings with those for the new Voice. In such a case, the original settings may not be restored even if you re-select the original Voice. To restore the original sound, select the same Style or Song again without executing the Save operation.</p>
[D]/[I]	PANPOT	Determines the stereo position of the selected part (channel).
[E]/[J]	VOLUME	Determines the volume of each part or channel, giving you fine control over the balance of all the parts.

Editing FILTER Parameters



[D]/[I]	HARMONIC CONTENT	Allows you to adjust the Resonance (page 14) for each part.
[E]/[J]	BRIGHTNESS	Determines the brightness of the sound for each part by adjusting the Cutoff Frequency (page 14).

Editing TUNE Parameters



[A]/[B] [F]/[G]	PORTAMENTO TIME	Portamento is a function that creates a smooth transition in pitch from the first note played on the keyboard to the next. The Portamento Time determines the pitch transition time. Higher values result in a longer pitch change time. Setting this to "0" results in no effect. This parameter is available only when the selected keyboard part is set to Mono.
[C]/[H]	PITCH BEND RANGE	Determines the range of the PITCH BEND wheel for each keyboard part. The range is from "0" to "12" with each step corresponding to one semitone.
[D]/[I]	OCTAVE	Determines the range of the pitch change in octaves, over two octaves up or down for each keyboard part. The value set here is added to the setting made via the OCTAVE [-]/[+] buttons.
[E]/[J]	TUNING	Determines the pitch of each keyboard part in cents. <div style="border: 1px solid black; padding: 2px; margin: 5px 0;"> NOTE In musical terms a "cent" is 1/100th of a semitone. (100 cents equal one semitone.) </div>
[1 ▲▼]- [3 ▲▼]	TRANSPOSE	Allows you to set transposition for overall sound of the instrument (MASTER), Song playback (SONG), or keyboard pitch (KBD), respectively. Please note that the "KBD" setting also transposes the pitch of Style playback and the Multi Pads (since these are also affected by keyboard play in the left-hand section).

Editing EFFECT Parameters

This instrument features eleven Effect Blocks, giving you powerful tools to richly enhance the sounds of the instrument or completely transform them. The Effects are divided into the following groups:

■ Reverb, Chorus

The Effects of these Blocks are applied to the overall sound or all Parts. In each of these Effect Blocks, you can select only one Effect Type at a time and adjust the Send Level (Depth) for each Part as well as the Return Level for all Parts.

■ DSP1

When the Connection is set to “System” on the EFFECT PARAMETER EDIT display (page 120), the Effects of this Block are applied only to the Style and Song sounds. In this status, you can select only one Effect Type at a time and adjust the Send Level (Depth) for each Part as well as Return Level for all Parts. When the Connection is set to “Insertion” on the EFFECT PARAMETER EDIT display, the Effect of this Block is applied to a specific channel of the Style and Song.

■ DSP2-9

The Effects of these Blocks are applied to a specific Part or Channel, with the exception of the Multi Pads and microphone input. Different Effect Types can be selected for each of the available Parts or Channels.

Adjusting the Effect Depth for Each Part



Use the [B]–[E] or [G]–[J] buttons to select the desired Effect Block, then use the [1 ▲▼]–[8 ▲▼] buttons to adjust the Effect Depth for each Part.

Selecting an Effect Type for Each Block

This section covers how to change the Effect Type of each Effect Block. The settings here can be saved to a Registration Memory, Song or Style.

- 1** Call up the desired page from PANEL, SONG or STYLE via the [MIXING CONSOLE] button.



- 2** In the EFFECT page, press the [F] (TYPE) button to call up the Effect Type Selection display.

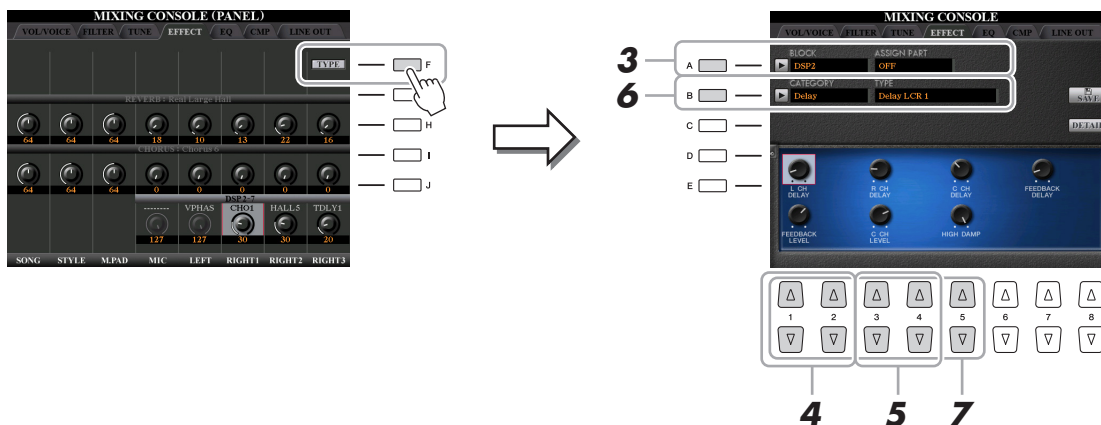

- 3** Press the [A] button.

- 4** Use the [1 ▲▼]/[2 ▲▼] buttons to select the Effect Block.

Effect Block	Effect-applicable parts	Effect characteristics
REVERB	All parts	Reproduces the warm ambience of playing in a concert hall or jazz club.
CHORUS	All parts	Produces a rich, “fat” sound as if several parts are being played simultaneously. In addition, other type effects (such as reverb, delay, etc.) can also be selected in this effect block.
DSP1	STYLE PART, SONG CHANNEL 1–16	This effect is applied only to Style/Song parts.
DSP2, DSP3, DSP4, DSP5, DSP6	RIGHT 1, RIGHT 2, RIGHT 3, LEFT, SONG CHANNEL 1–16	Any unused DSP blocks are automatically assigned to the appropriate parts (channels) as needed. Only one DSP block can be assigned to each keyboard or Song part.
DSP7	Microphone sound, SONG CHANNEL 1–16	This effect is applied to the MIC input (in addition to the Vocal Harmony effect)/Song parts.
DSP8, DSP9	STYLE PART	These effects are applied only to Style parts.

- 5** Use the [3 ▲▼]/[4 ▲▼] buttons to select the Part to which you want to apply the effect.

Note that a Part cannot be selected if “REVERB,” “CHORUS,” or “DSP1” is selected. This is because only one of the Effect Types can be selected to be commonly applied to all available Parts.

- 6** Press the [B] button.

- 7** Use the [1 ▲▼]/[2 ▲▼] buttons to select the Category then use the [3 ▲▼]–[5 ▲▼] buttons to select the Effect Type.

Note that the Reverb Block is not divided into any Categories.

If you want to edit detailed Parameters of the selected Effect Type, press the [H] (DETAIL) button. For details, refer to the next section.

- 8** Save the Effect Settings to a Registration Memory, Song or Style.

For instructions, refer to the Owner’s Manual.

Editing and Saving Your Original Effect Type

You can edit detailed parameters of the selected Effect Type. The parameter settings can be saved as your original Effect Type as well as to a Registration Memory, Style or Song as described in the previous section. This section covers how to save the settings as an original Effect Type.

- 1 Once you've selected an Effect Block and Effect Type above, press the [H] (DETAIL) button to call up the display for editing the effect parameters.



- 2 Use the [4 ▲▼]/[5 ▲▼] buttons to select a parameter then use the [6 ▲▼]/[7 ▲▼] buttons to edit the value.

When Reverb, Chorus, or DSP1 is selected as the Effect Block, you can adjust the Return Level via the [8 ▲▼] button. If you want to change the Effect Block and Type, use the [1 ▲▼]–[3 ▲▼] buttons.

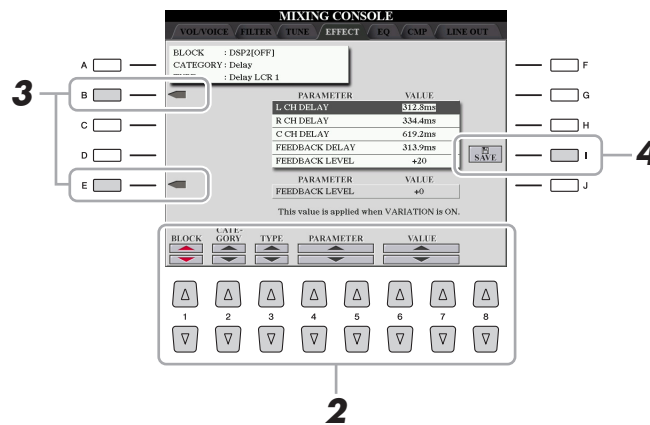

- 3 If DSP 2–9 is selected as the Effect Block, edit the Variation parameter if desired.

Press the [E] button to move the cursor to the Variation parameter, then edit the value via the [6 ▲▼]/[7 ▲▼] buttons. This parameter is effective only when the [VARIATION] button lamp lights on the panel. To move the cursor to the normal parameters, press the [B] button.

NEXT PAGE

4 Press the [I] (SAVE) button to call up the User Memory menu.

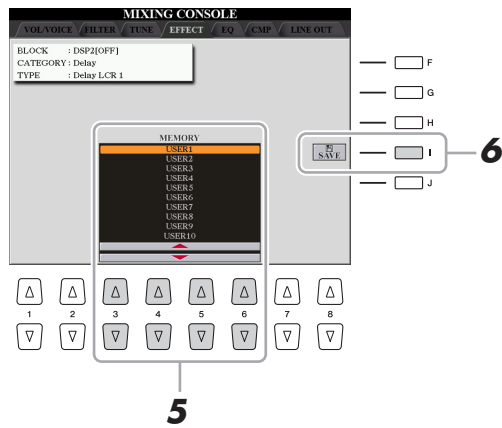

5 Use the [3 ▲▼]–[6 ▲▼] buttons to select the destination for saving the settings as a User Effect.

6 Press the [I] (SAVE) button again to execute the Save operation.

In the Naming window called up via this operation, assign the name to the User Effect Type then press the [8 ▲] (OK) button to save the User Effect Type. If you want to call up the User Effect Type saved here, select the corresponding Effect Block and “USER” Category in the Effect Type Selection display.

Editing EQ Parameters

Equalizer (also called “EQ”) is a sound processor that divides the frequency spectrum into multiple bands that can be boosted or cut as required to tailor the overall frequency response. Usually an equalizer is used to correct the sound from speakers to match the special character of the room. For example, you can cut some of the low range frequencies when playing in large spaces where the sound is too “boomy,” or boost the high frequencies in rooms and close spaces where the sound is relatively “dead” and free of echoes.

As shown below, this instrument possesses a high grade five-band Master EQ which is applied to the entire sound. You can select one of five preset EQ types and create two User Master EQ types by editing the related parameters. In addition to the Master EQ, Part EQ is available, letting you boost/cut the high band or low band for each Part.

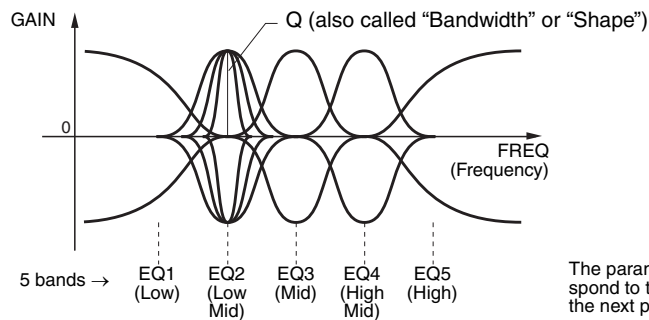

The parameters of this diagram correspond to those edited in Steps 3–4 on the next page.



MASTER EQ

[B]/[C]	TYPE	Selects the desired Master EQ type. This affects the overall sound of the instrument.
[F]	EDIT	For editing the Master EQ. See page 123 .

PART EQ

[D]/[I]	EQ HIGH	Boosts or attenuates the high EQ band for each part.
[E]/[J]	EQ LOW	Boosts or attenuates the low EQ band for each part.

Editing and Saving Your Original Master EQ Type

1 Press the [F] (EDIT) button in the EQ Page.

The MASTER EQ EDIT display is called up.

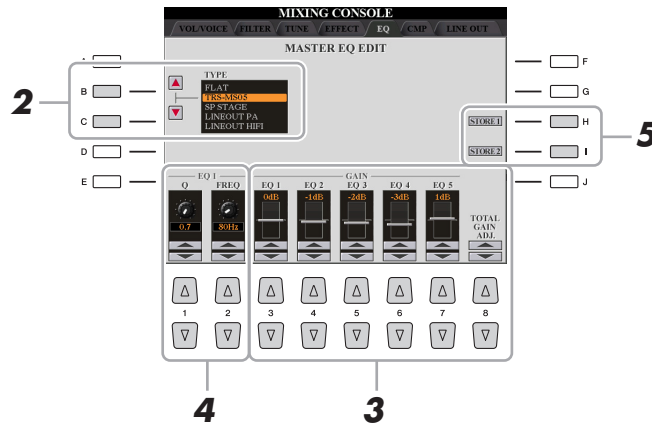

2 Use the [B]/[C] buttons to select a preset EQ type.

The set parameters of the selected EQ type are automatically shown at the bottom of the display.

3 Use the [3 ▲▼]–[7 ▲▼] buttons to boost or cut each of the five bands.

Use the [8 ▲▼] buttons to boost or cut all the five bands at the same time.

4 If desired, adjust the Q (bandwidth) and the FREQ (center frequency) of the band selected in step 3.

To adjust the bandwidth (also called “Shape” or “Q”), use the [1 ▲▼] buttons. The higher the value of Q, the narrower the band width.

To adjust the FREQ (center frequency), use the [2 ▲▼] buttons. The available FREQ range is different for each band.

5 Press the [H] or [I] (STORE 1 or 2) button to execute the Store operation.

In the Naming display called up via this operation, assign the name then press the [8 ▲] (OK) button to store your settings as a User Master EQ Type, which can be called up via the [B]/[C] buttons.

Editing Master Compressor Settings

For details, refer to the Owner’s Manual.

Line Out Settings

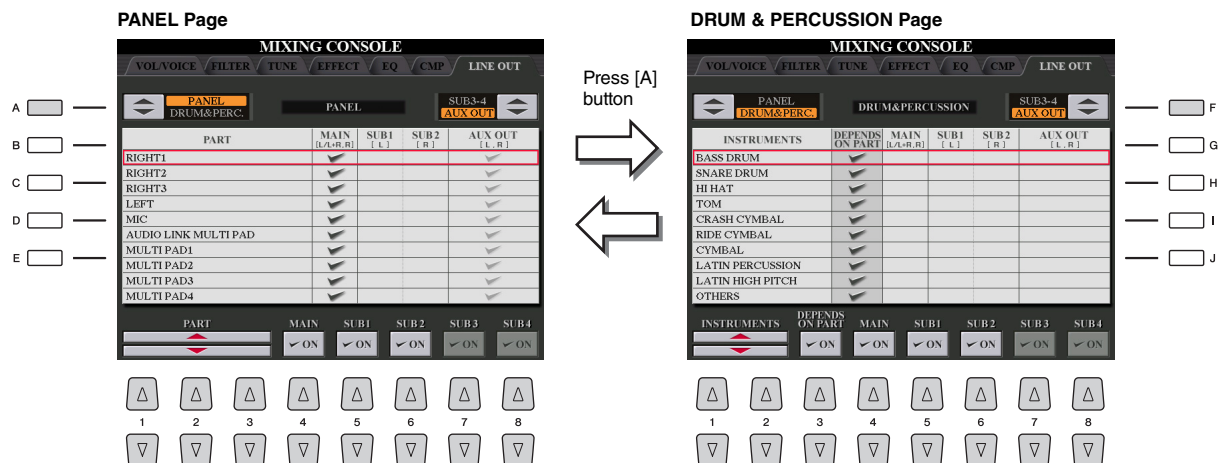

[A]	DRUM&PERC./ PANEL	Switches the displayed menu: PANEL parts or DRUM & PERCUSSION instruments.
[F]	SUB3-4/ AUX OUT	Switches the displayed menu: SUB3-4 or AUX OUT. This also actually switches the role of the LINE OUT SUB [3]-[4] jacks or AUX OUT jacks accordingly.
[1 ▲▼]- [3 ▲▼]	PART (PANEL Page)	Selects the desired part/drum instrument.
[1 ▲▼]/ [2 ▲▼]	INSTRUMENTS (DRUM & PERCUSSION Page)	
[3 ▲▼]	DEPENDS ON PART (DRUM & PERCUSSION Page)	When this is checked, the selected drum instrument will be output via the jacks set from the PANEL page at left.
[4 ▲▼]	MAIN	When this is checked, the selected part/drum instruments will be output from LINE OUT MAIN jacks, PHONES jacks, LOOP SEND jack, and optional speaker.
[5 ▲▼]	SUB1	When one of these columns (jacks) is checked, the selected part/drum instruments will be output from only the selected SUB jack(s). NOTE Only the DSP 2-9 and Vocal Harmony effects can be applied to the sound output from the SUB jacks. Other effects (Reverb, Chorus and DSP 1) will not be applied. (If the "Connection" parameter of DSP 1 is set to "Insertion," DSP 1 will also be applied.)
[6 ▲▼]	SUB2	
[7 ▲▼]	SUB3	
[8 ▲▼]	SUB4	

Block Diagram

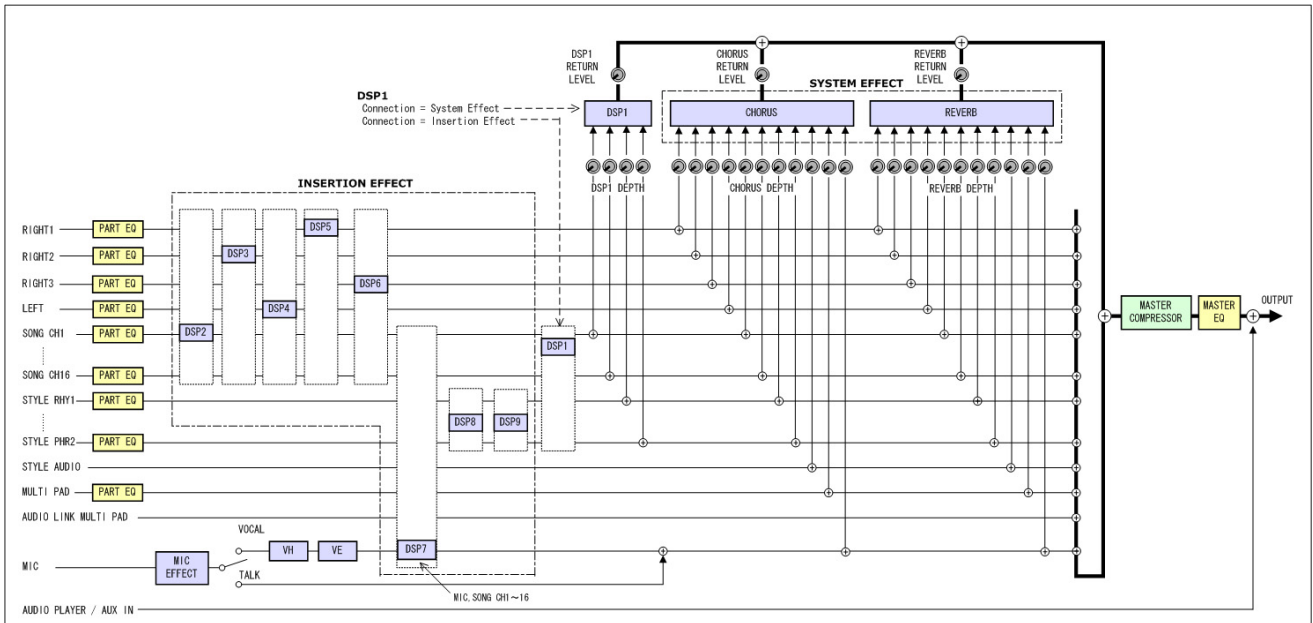

Contents

CONFIG 1	126
CONFIG 2	128
MEDIA.....	129
OWNER.....	130
SYSTEM RESET.....	131
• Factory Reset—Restoring the Factory Programmed Settings.....	131
• Custom Reset—Backup/Restore	132

CONFIG 1

Select the desired parameter:

- 1 Fade In/Out
- 2 Metronome
- 3 Parameter Lock
- 4 Tap
- 5 Auto Power Off

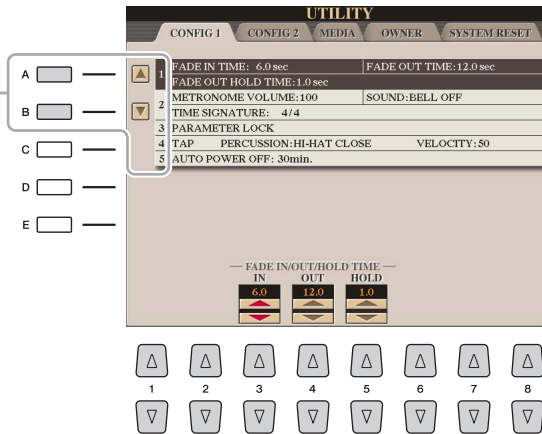

1 Fade In/Out

These parameters determine how Style or Song playback is faded in/out when using the [FADE IN/OUT] button.

[3 ▲▼]	FADE IN TIME	Determines the time it takes for the Style/Song volume to fade in, or go from minimum to maximum (range of 0–20.0 seconds).
[4 ▲▼]	FADE OUT TIME	Determines the time it takes for the Style/Song volume to fade out, or go from maximum to minimum (range of 0–20.0 seconds).
[5 ▲▼]	FADE OUT HOLD TIME	Determines the time the volume is held at 0 following the fade out (range of 0–5.0 seconds).

2 Metronome

[2 ▲▼]	VOLUME	Determines the volume of the metronome sound.
[3 ▲▼]– [5 ▲▼]	SOUND	Determines whether a bell accent is sounded or not at the first beat of each measure.
[6 ▲▼]/ [7 ▲▼]	TIME SIGNATURE	Determines the time signature of the metronome sound.

3 Parameter Lock

This lets you lock or maintain the settings of specific parameters (such as Effect and Split Point), even when the panel setups are changed by Registration Memory, One Touch Setting, etc. To set this function, use the [1 ▲▼]–[7 ▲▼] (SELECT) buttons to select the desired parameter then use the [8 ▲]/[8 ▼] (MARK ON/OFF) buttons to enter or remove the checkmarks. Repeat this step as desired. Items having checkmarks will be locked.

4 Tap

This allows you to set the percussion sound and the velocity which sounds when the [TAP TEMPO] button is tapped.

[2 ▲▼]– [4 ▲▼]	PERCUSSION	Selects the percussion sound.
[5 ▲▼]/ [6 ▲▼]	VELOCITY	Sets the velocity.

5 Auto Power Off

For details, refer to the Owner's Manual.

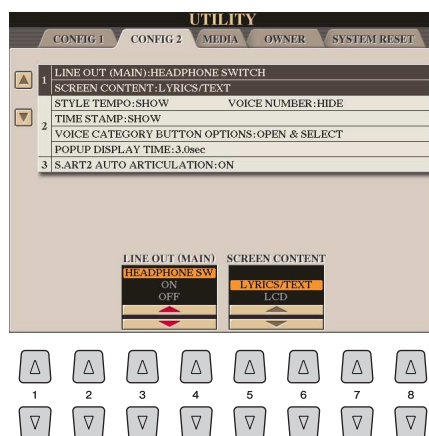

CONFIG 2



1 Line Out (MAIN) / Screen Content

[3 ▲▼]/ [4 ▲▼]	LINE OUT (MAIN)	Determines whether or not the sound is output via LINE OUT (MAIN). HEADPHONE SW: LINE OUT (MAIN) sounds normally, but is cut off when headphones are inserted to the PHONES jack. ON: Sound is output via LINE OUT (MAIN), even if headphones are connected. OFF: LINE OUT (MAIN) sound is off.
[5 ▲▼]/ [6 ▲▼]	SCREEN CONTENT	Selects display contents for the external monitor. For details, refer to the Owner's Manual.

2 Display-related settings / Voice Category Button Options

[1 ▲▼]	STYLE TEMPO	Selects whether or not the default tempo of each preset Style is displayed above the preset Style name in the Style Selection display.
[2 ▲▼]	VOICE NUMBER	Determines whether or not the Voice bank and number are shown in the Voice Selection display. This is useful when you want to check which bank select MSB/LSB values and program change number you need to specify when selecting the Voice from an external MIDI device.  NOTE The numbers displayed here start from "1." Accordingly the actual MIDI program change numbers are one lower, since that number system starts from "0."  NOTE For the GS Voices, the Display Voice Number is not available (the program change numbers are not shown).
[3 ▲▼]	TIME STAMP	Determines whether or not the Updated Date and Updated Time are shown on the File Selection display.
[5 ▲▼]/ [6 ▲▼]	VOICE CATEGORY BUTTON OPTIONS	Determines how the Voice Selection display is opened when one of the VOICE buttons is pressed. OPEN & SELECT: Opens the Voice Selection display with the previously selected Voice in the Voice category automatically selected (when one of the VOICE buttons is pressed). OPEN ONLY: Opens the Voice Selection display with the currently selected Voice (when one of the VOICE buttons is pressed).
[7 ▲▼]/ [8 ▲▼]	POPUP DISPLAY TIME	Determines the time in which the popup windows close. (Popup windows are displayed when you press buttons such as TEMPO, TRANSPOSE or UPPER OCTAVE, etc.)

3 S.Art2 Auto Articulation

Determines whether articulation is added to S.Art2 Voices automatically.

NOTE

This affects not only S.Art2 Voices of your keyboard performance, but also the S.Art2 Voices in Songs or Styles.

MEDIA

You can set or execute important media-related operations for the Tyros5. The word “media” refers to both the USB storage device and internal hard disk drive.

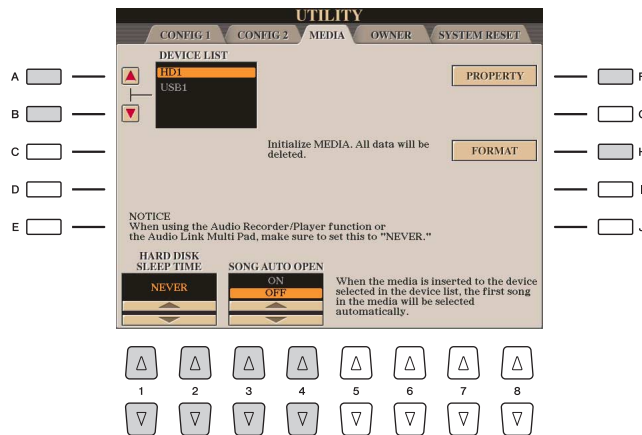

[A]/[B]	DEVICE LIST	Selects the desired media for which you want to check the remaining memory (see “PROPERTY” below) or format the media (see the Owner’s Manual).
[F]	PROPERTY	Opens the Property display of the media selected by [A]/[B] buttons. You can check the amount of remaining memory on the media. NOTE The displayed remaining memory value is an approximate value.
[H]	FORMAT	Formats the media selected by [A]/[B] buttons. Refer to the Owner’s Manual, chapter 11.
[1 ▲▼]/ [2 ▲▼]	HARD DISK SLEEP TIME	The hard disk unit will go into a “sleep” mode after a specified time of inactivity, both to maximize the lifetime of the hard disk and to minimize unnecessary mechanical noise. This parameter determines the sleep time. NOTE When using the Audio Recorder/Player function or the Audio Link Multi Pad, make sure to set this to “NEVER.”
[3 ▲▼]/ [4 ▲▼]	SONG AUTO OPEN	Turns the Song Auto Open function on or off. When this is set to “ON” and the media selected in the Device List above is inserted, the Tyros5 automatically calls up the first Song in the media.

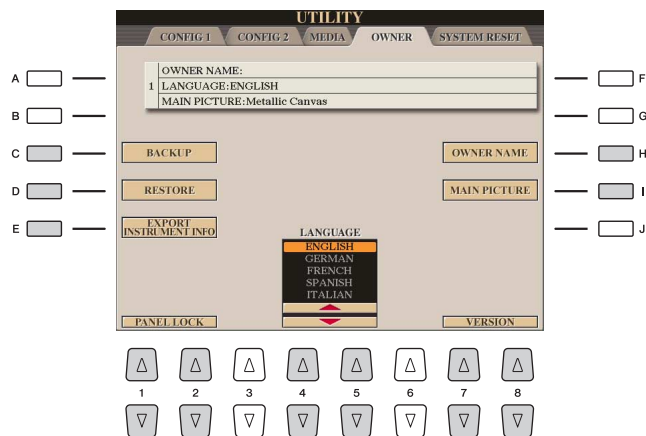

[C]	BACKUP	Lets you backup all data on the instrument to a USB flash memory. For instructions, refer to the Basic Operation section in the Owner’s Manual.
[D]	RESTORE	For loading backup files from the USB flash memory. For instructions, refer to the Basic Operation section in the Owner’s Manual.
[E]	EXPORT INSTRUMENT INFO	For exporting identification information of the instrument, which is necessary for purchasing Expansion Contents, to the root directory of the USB flash memory device. The exported file is named “TYROS5_InstrumentInfo.n27.”
[H]	OWNER NAME	Lets you enter your name as the owner. The Owner name is indicated on the opening display when you turn the power on. For instructions, refer to the Basic Operation section in the Owner’s Manual.
[I]	MAIN PICTURE	Lets you select a background picture for the Main display. You can select a picture from among various pictures provided on the Preset Page. After selecting, press the [EXIT] button to close the Selection display. If you want to use an original picture, prepare the desired file (a bitmap “.BMP” file no greater than 320 x 240 pixels) in the USB flash memory, copy it from the USB flash memory to the USER page, then select it from the USER page. Due to access speed limitations, it is not recommended to select the desired file from the USB flash memory. NOTE The explanation about picture compatibility above applies also to the background of the Song Lyric display (page 53).
[1 ▲▼]/ [2 ▲▼]	PANEL LOCK	For details, refer to the Owner’s Manual.
[4 ▲▼]/ [5 ▲▼]	LANGUAGE	Determines the language used for the display messages. Once you change this setting, all messages will be shown in the selected language.
[7 ▲▼]/ [8 ▲▼]	VERSION	Displays the program version and the hardware ID of this instrument.

SYSTEM RESET

In this display, you can execute one of two reset methods: Factory Reset and Custom Reset. Factory Reset lets you call up the default initial settings for each item while Custom Reset lets you call up your original settings with a single touch.

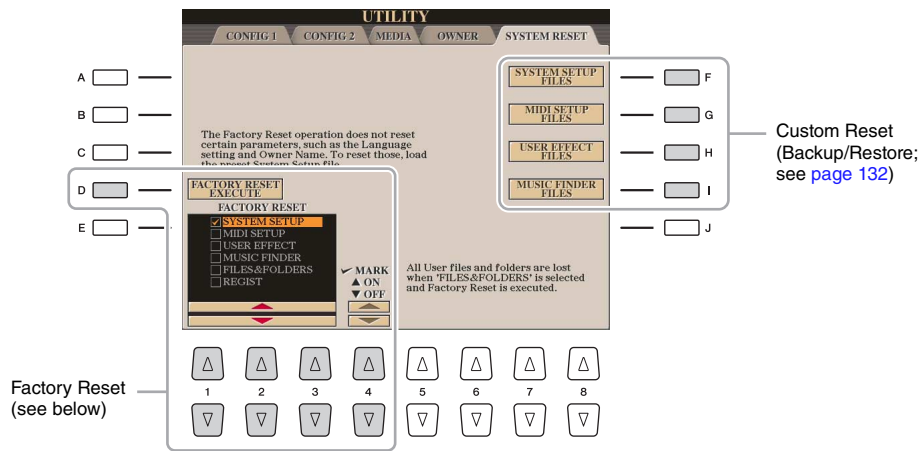

Factory Reset—Restoring the Factory Programmed Settings

This function lets you restore the status of the instrument to the original factory settings.

- 1 Use the [1 ▲▼]–[3 ▲▼] buttons to select the desired item, then press the [4 ▲▼] buttons to enter or remove the checkmark.

When an item is checkmarked, the corresponding parameters will be reset as described below:

SYSTEM SETUP	Resets the System Setup parameters to the original factory settings. Refer to the Data List (Parameter Chart) for details about which parameters belong to System Setup.
MIDI SETUP	Resets the MIDI settings including the MIDI Setups on the USER tab display to the original factory status.
USER EFFECT	Resets the current Effect settings and the following data: <ul style="list-style-type: none"> • User Effect Types..... page 120 • User Master EQ Types..... page 123 • User Compressor Types..... page 123 • User Vocal Harmony Types..... page 106 • User Microphone Settings..... page 101
MUSIC FINDER	Resets the Music Finder data (all Records) to the original factory settings.
FILES & FOLDERS	Deletes all files and folders including the Expansion folder stored in the HD1 tab display.
REGIST	Turns off all the Registration Memory [1]–[8] lamps, indicating that no Registration Memory Bank is selected although all the Registration Memory Bank files are maintained. In this status, you can create Registration Memory setups from the current panel settings. <p>NOTE</p> <p>The same operation can be done by turning the power on while holding the highest key. In this case, you can create Registration Memory setups from the default panel settings.</p>

- 2 Press the [D] (FACTORY RESET EXECUTE) button to execute the Factory Reset operation for all checkmarked items.

Custom Reset—Backup/Restore

For the items below, you can save your original settings to USER or USB drive as a single file for future recall.

1 Make all desired settings on the instrument.

2 Call up the operation display.

[FUNCTION] → [H] UTILITY → TAB [◀][▶] SYSTEM RESET

3 Press one of the [F]–[I] buttons to call up the relevant display for saving your data.

[F]	SYSTEM SETUP FILES	Parameters set on the various displays such as the [FUNCTION] → [H] UTILITY and microphone setting display are handled as a single System Setup file. Refer to the Data List (Parameter Chart) for details on which parameters belong to System Setup.
[G]	MIDI SETUP FILES	The MIDI settings including the MIDI Setups on the USER tab display are handled as a single file.
[H]	USER EFFECT FILES	The following data can be managed as a single file. <ul style="list-style-type: none"> • User Effect Types.....page 120 • User Master EQ Types.....page 123 • User Compressor Types.....page 123 • User Vocal Harmony Typespage 106 • User Microphone Settingspage 101
[I]	MUSIC FINDER FILES	All the preset and created Records of the Music Finder are handled as a single file.

4 Use the TAB [◀][▶] buttons to select one of the tabs (USER or USB) to which your settings will be saved.

5 Press the [6 ▼] (SAVE) button to save your file.

6 To recall your file, press the desired [F]–[I] buttons in the SYSTEM RESET display, then select the desired file.

When the file is selected, a message is displayed according to the content of the file. Press the desired button.

Contents

Footswitch/Foot Controller Settings.....	133
• Assigning a Specific Function to Each Pedal.....	133
MIDI Settings.....	136
• MIDI System Settings.....	138
• MIDI Transmit Settings.....	139
• MIDI Receive Settings.....	140
• Bass Note Settings for Style Playback via MIDI Receive.....	141
• Chord Type Settings for Style Playback via MIDI Receive.....	141
MFC10 Settings.....	142
Connecting to a Network (Bundled USB Wireless LAN Adaptor).....	144
• Displaying Available Networks and Making Connections.....	144
• Entering the SSID, Security and Password Settings in Manual Setup.....	145
• Starting WPS from the Tyros5.....	146
• Manually Setting the Access Point Mode.....	146
• Setting the Time Zone.....	147

Footswitch/Foot Controller Settings

Assigning a Specific Function to Each Pedal

The functions of the foot pedals connected to the ASSIGNABLE FOOT PEDAL 1/2/3 jacks can be changed individually from the default settings (sustain, etc.)—for example, letting you use the footswitch to start/stop Style playback, or use the foot controller to produce pitch bends.

NOTE

For information on how to connect a foot pedal or what kinds of pedals can be connected, refer to the Owner's Manual, chapter 11.

1 Call up the operation display.

[FUNCTION] → [D] CONTROLLER → TAB [◀][▶] FOOT PEDAL

2 Use the [A]/[B] buttons to select one of the three foot pedals to which the function is to be assigned.

On the display, the numbers 1, 2 and 3 correspond to the FOOT PEDAL jacks 1, 2 and 3 respectively.

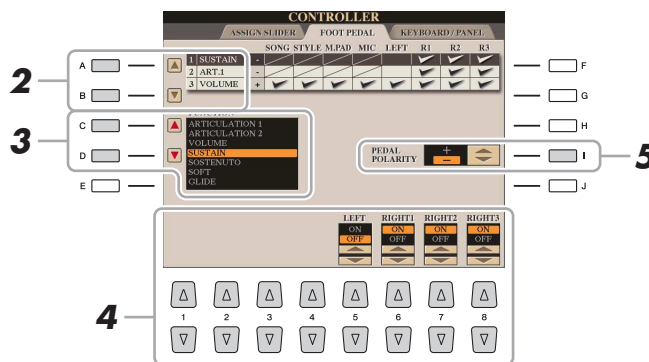

3 Use the [C]/[D] buttons to select the function to be assigned to the pedal specified in step 2.

For information on available functions, see [pages 134–135](#).

4 Use the [1 ▲▼]–[8 ▲▼] buttons to set the details of the selected functions (the part for which the function is applied, etc.).



The available parameters differ depending on the function selected in step 3.

5 If necessary, set the polarity of the pedal by using the [I] button.

Pedal on/off operation may differ depending on the particular pedal you've connected to the instrument. For example, pressing down on one pedal may turn the selected function on, while pressing a different make/brand of pedal may turn the function off. If necessary, use this setting to reverse the operation.

Assignable Pedal Functions

For functions indicated with an asterisk (*), use only a foot controller; proper operation cannot be done with a footswitch.

ARTICULATION 1/2	When you use a Super Articulation Voice that has an effect assigned to the pedal/footswitch, you can enable the effect by pressing the pedal/footswitch. You can turn this function on or off for each keyboard part on this display.
VOLUME*	Allows you to use a foot controller to control the volume. You can turn this pedal function on or off for each part on this display.
SUSTAIN	Allows you to use a pedal to control the sustain. When you press and hold the pedal, all notes played on the keyboard have a longer sustain. Releasing the pedal immediately stops (damps) any sustained notes. You can turn this pedal function on or off for each keyboard part on this display.
SOSTENUTO	Allows you to use a pedal to control the Sostenuato effect. If you play a note or chord on the keyboard and press the pedal while holding the note(s), the notes will sustain as long as the pedal is held. However, all subsequent notes will not sustain. This makes it possible to sustain a chord, for example, while other notes are played staccato. You can turn this pedal function on or off for each keyboard part on this display.  NOTE This function will not affect any of the Organ Flutes and only some of the Super Articulation Voices, even if this has been assigned to the foot pedals.
SOFT	Allows you to use a pedal to control the Soft effect. Pressing this pedal reduces the volume and changes the timbre of the notes you play. This is effective only for certain appropriate Voices. You can turn this pedal function on or off for each keyboard part on this display.
GLIDE	When the pedal is pressed, the pitch changes, and then returns to normal pitch when the pedal is released. The following parameters can be set for this function on this display. UP/DOWN: Determines whether the pitch change goes up (is raised) or down (is lowered). RANGE: Determines the range of the pitch change, in semitones. ON SPEED: Determines the speed of the pitch change when the pedal is pressed. OFF SPEED: Determines the speed of the pitch change when the pedal is released. LEFT, RIGHT 1, 2, 3: Turns this pedal function on or off for each keyboard part.
PORTAMENTO	The portamento effect (a smooth slide between notes) can be produced while the pedal is pressed. Portamento is produced when notes are played legato style (i.e., a note is played while the preceding note is still held). The portamento time can also be adjusted from the Mixing Console display (page 117). You can turn this pedal function on or off for each keyboard part on this display.  NOTE This function affects only certain Voices, especially synth lead and some bass Voices. It will not affect any of the Organ Flutes, Super Articulation 2 Voices and only some of the Super Articulation Voices, even if the function has been assigned to the Foot Pedals.
PITCH BEND*	Allows you to bend the pitch of notes up or down by using the pedal. The following parameters can be set for this function on this display. UP/DOWN: Determines whether the pitch change goes up (is raised) or down (is lowered). RANGE: Determines the range of the pitch change, in semitones. LEFT, RIGHT 1, 2, 3: Turns this pedal function on or off for each keyboard part.

NOTE

You can also assign other functions to the pedal—Punch in/out of Song ([page 67](#)) and Registration Sequence ([page 97](#)). If you assign multiple functions to the pedal, the priority is: Punch in/out of Song → Registration Sequence → Functions assigned here.

MODULATION*	Applies vibrato and other effects to notes played on the keyboard. You can turn this pedal function on or off for each keyboard part on this display.
MODULATION (ALT)	This is a slight variation on MODULATION above, in which the effects (waveform) can be switched on/off by each press of the pedal/footswitch. The modulation effect is alternately turned on and off each time the pedal/footswitch is pressed. You can turn this function on or off for each keyboard part on this display.
DSP VARIATION	Same as the [DSP VARIATION] button on the panel.
PEDAL CONTROL (WAH)	Allows you to use a foot controller to control the Pedal Wah effect.
HARMONY/ECHO	Same as the [HARMONY/ECHO] button.
VOCAL HARMONY	Same as the [VOCAL HARMONY] button.
VOCAL EFFECT	Same as the [EFFECT] button.
TALK	Same as the [TALK] button.
SCORE PAGE +/-	While the Song is stopped, you can turn to the next/previous score page (one page at a time).
LYRICS PAGE +/-	While the Song is stopped, you can turn to the next/previous lyrics page (one page at a time).
TEXT PAGE +/-	You can turn to the next/previous text page (one page at a time).
AUDIO PLAY/PAUSE	Same as the AUDIO RECORDER/PLAYER [PLAY/PAUSE] button.
SONG PLAY/PAUSE	Same as the SONG [PLAY/PAUSE] button.
STYLE START/STOP	Same as the STYLE CONTROL [START/STOP] button.
TAP TEMPO	Same as the [TAP TEMPO] button.
SYNCHRO START	Same as the [SYNC START] button.
SYNCHRO STOP	Same as the [SYNC STOP] button.
INTRO 1–3	Same as the INTRO [I]–[III] buttons.
MAIN A–D	Same as the MAIN VARIATION [A]–[D] buttons.
FILL DOWN	Plays a fill-in, which is automatically followed by the previous Main section (that of the button on the immediate left).
FILL SELF	Plays a fill-in.
FILL BREAK	Plays a break.
FILL UP	Plays a fill-in, followed by the next Main section (that of the button on the immediate right).
ENDING1–3	Same as the ENDING/rit. [I]–[III] buttons.
FADE IN/OUT	Same as the [FADE IN/OUT] button.
FINGERD/FING ON BASS	The pedal alternately switches between the Fingered and On Bass modes (page 27).
BASS HOLD	While the pedal is pressed, the Accompaniment Style bass note will be held even if the chord is changed during Style playback. If the fingering is set to “AI FULL KEYBOARD,” the function does not work.
PERCUSSION	<p>The pedal plays a percussion instrument selected by the [4 ▲▼]–[8 ▲▼] buttons. You can use the keyboard to select the desired percussion instrument.</p> <p> NOTE</p> <p>When you select the percussion instrument by pressing a key on the keyboard, the velocity with which you press the key determines the percussion volume.</p>
RIGHT 1 ON/OFF	Same as the PART ON/OFF [RIGHT 1] button.
RIGHT 2 ON/OFF	Same as the PART ON/OFF [RIGHT 2] button.
RIGHT 3 ON/OFF	Same as the PART ON/OFF [RIGHT 3] button.
LEFT ON/OFF	Same as the PART ON/OFF [LEFT] button.
OTS +/-	Calls up the next/previous One Touch Setting.

MIDI Settings

In this section, you can make MIDI-related settings for the instrument. The Tyros5 gives you a set of ten pre-programmed templates that let you instantly and easily reconfigure the instrument to match your particular MIDI application or external device. Also, you can edit the pre-programmed templates and save up to ten of your original templates to USER memory.

NOTE

You can save all your original templates as a single file to internal memory (User drive) or a USB flash memory: [FUNCTION] → [H] UTILITY → TAB [◀][▶] SYSTEM RESET → [G] MIDI SETUP FILES. See [page 132](#).

1 Call up the operation display.

[FUNCTION] → [G] MIDI

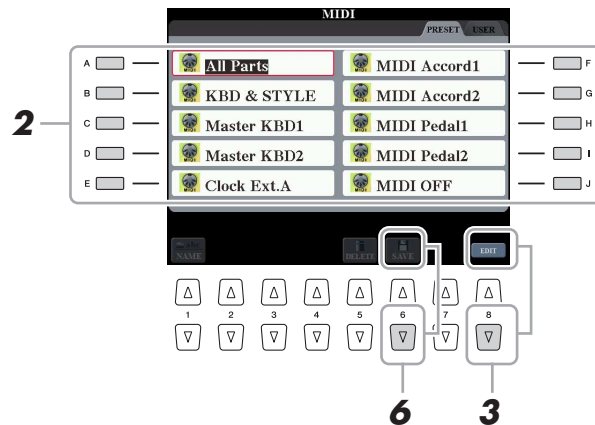

2 Select a pre-programmed template from the Preset page ([page 137](#)).

If you have already created your original template and saved it to the User page, you can also select that template from the User page.

3 To edit the template, press the [8 ▼] (EDIT) button to call up the MIDI display.

4 Use the TAB [◀][▶] buttons to call up the relevant page, then set various parameters to edit the current MIDI template.

- SYSTEMMIDI System Settings ([page 138](#))
- TRANSMITMIDI Transmit Settings ([page 139](#))
- RECEIVEMIDI Receive Settings ([page 140](#))
- BASSBass Note Settings for Style Playback via MIDI Receive ([page 141](#))
- CHORD DETECTChord Type Settings for Style Playback via MIDI Receive ([page 141](#))
- MFC10Settings for a connected MFC10 MIDI Foot Controller ([page 142](#))

5 When you've finished editing, press the [EXIT] button to return to the MIDI template Selection display.

6 Select the User page by using the TAB [◀][▶] buttons, then press the [6 ▼] (SAVE) button to save the edited template.

Pre-programmed MIDI Templates

All Parts	Transmits all parts including the keyboard parts (RIGHT 1, 2, 3, LEFT), with the exception of the Song parts.
KBD & STYLE	Basically the same as “ALL PARTS” with the exception of how keyboard parts are managed. The right-hand parts are handled as “UPPER” instead of RIGHT 1–3 and the left-hand part is handled as “LOWER.”
Master KBD1	In this setting, the Tyros5 functions as a “master” keyboard, for playing and controlling one or more connected tone generators or other devices (such as a computer/sequencer).
Master KBD2	Basically the same as “Master KBD1” above, with the exception that After Touch messages are not transmitted.
Clock Ext. A	Playback or recording (Song, Style, Multi Pad, etc.) synchronizes with an external MIDI clock instead of the Tyros5’s internal clock. This template should be used when you wish to set the tempo on the MIDI device connected to the Tyros5. Playback or recording of the Tyros5 synchronizes with an external clock received via MIDI A.
MIDI Accord 1	MIDI accordions allow you to transmit MIDI data and play connected tone generators from the keyboard and bass/chord buttons of the accordion. This template lets you play melodies from the keyboard and control Style playback on the Tyros5 with the left-hand buttons.
MIDI Accord 2	Basically the same as “MIDI Accord1” above, with the exception that the chord/bass notes you play with your left hand on the MIDI Accordion are recognized also as MIDI note events.
MIDI Pedal 1	MIDI pedal units allow you play connected tone generators with your feet (especially convenient for playing single note bass parts). This template lets you play/control the chord root in Style playback with a MIDI pedal unit (connected to MIDI B only).
MIDI Pedal 2	This template lets you play the bass part for Style playback by using a MIDI pedal unit (connected to MIDI B only).
MIDI OFF	No MIDI signals are sent or received.

MIDI System Settings

The explanations here apply to the SYSTEM page in step 4 on page 136.

Use the [A]/[B] buttons to select the parameters (below), then set the ON/OFF status by using the [1 ▲▼]–[8 ▲▼] buttons.

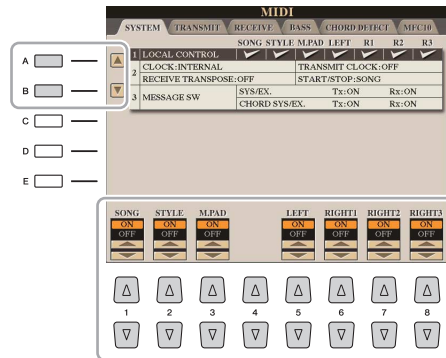

■ 1 Local Control

Turns the Local Control for each part on or off. When Local Control is set to “ON,” the keyboard of the instrument controls its own (local) internal tone generator, allowing the internal Voices to be played directly from the keyboard. If you set Local to “OFF,” the keyboard and controllers are internally disconnected from the instrument’s tone generator section so that no sound is output when you play the keyboard or use the controllers. For example, this allows you to use an external MIDI sequencer to play the instrument’s internal Voices, and use the instrument keyboard to record notes to the external sequencer and/or play an external tone generator.

■ 2 Clock setting, etc.

CLOCK

Determines whether the tempo of the Songs, Styles, etc. are controlled by the instrument’s own internal clock or a MIDI clock signal received from an external device. INTERNAL is the normal Clock setting when the instrument is being used alone or as a master keyboard to control external devices. If you are using the instrument with an external sequencer, MIDI computer, or other MIDI device, and you want to synchronize it to that device, set this parameter to the appropriate setting: MIDI, USB 1, or USB 2. In this case, make sure that the external device is connected properly (e.g., to the instrument’s MIDI IN terminal), and that it is properly transmitting a MIDI clock signal.

TRANSMIT CLOCK

Turns MIDI clock (F8) transmission on or off. When set to OFF, no MIDI clock or Start/Stop data is transmitted even if a Song or Style is played back.

RECEIVE TRANPOSE

Determines whether or not the instrument’s transpose setting is applied to the note events received by the instrument via MIDI.

START/STOP

Determines whether incoming start and stop messages (FA, FC) affect Song or Style playback.

■ 3 MESSAGE SW (Message Switch)

SYS/EX.

The “Tx” setting turns MIDI transmission of MIDI System Exclusive messages on or off. The “Rx” setting turns MIDI reception and recognition of MIDI System Exclusive messages generated by external equipment on or off.

CHORD SYS/EX.

The “Tx” setting turns MIDI transmission of MIDI chord exclusive data (Chord Detect, root and type) on or off. The “Rx” setting turns MIDI reception and recognition of MIDI chord exclusive data generated by external equipment on or off.

NOTE

- When CLOCK is set to a value other than INTERNAL, the tempo is indicated as “EXT.” on the Main display. This means that playback of this instrument is controlled only from an external MIDI device or computer. In this condition, Styles, Songs, Multi Pads or the Metronome cannot be played back even if you execute the start operation.
- When the Wireless LAN Adaptor is connected to the USB TO DEVICE terminal, the “WIRELESS LAN” parameter appears.

MIDI Transmit Settings

The explanations here apply to the TRANSMIT page in step 4 on page 136. This determines which parts will be sent as MIDI data and over which MIDI channel the data will be sent.

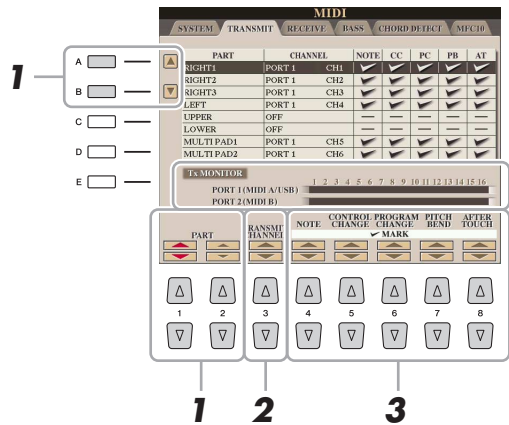

The dots corresponding to each channel (1–16) flash briefly whenever any data is transmitted on the channel(s).

NOTE

If “WLAN” is shown in the PORT1 line, this instrument can handle MIDI messages received via a Wireless LAN Adaptor connected to the USB TO DEVICE terminal. When “WLAN” is not shown although the Wireless LAN Adaptor is connected, turn the instrument off then on again.

1 Use the [A]/[B] buttons or [1 ▲▼]/[2 ▲▼] buttons to select the part for changing transmit settings.

The Parts listed on this display are the same as those shown in the MIXING CONSOLE display and CHANNEL ON/OFF display with the exception of the two parts below.

UPPER

Refers to a keyboard part played on the right side of the keyboard from the Split Point for the Voices (RIGHT 1, 2, and 3).

LOWER

Refers to a keyboard part played on the left side of the keyboard from the Split Point for the Voices. This is not affected by the on/off status of the [ACMP] button.

2 Use the [3 ▲▼] buttons to select the channel via which the selected part will be transmitted.

3 Use the [4 ▲▼]–[8 ▲▼] button to determine the types of data to be sent.

The following MIDI messages can be set on the TRANSMIT/RECEIVE display.

- NOTE (Note events)page 73
- CC (Control Change).....page 73
- PC (Program Change).....page 73
- PB (Pitch Bend).....page 73
- AT (After Touch).....page 73

NOTE

If the same transmit channel is assigned to several different parts, the transmitted MIDI messages are merged to a single channel—resulting in unexpected sounds and possible glitches in the connected MIDI device.

NOTE

Protected Songs cannot be transmitted even if the proper Song channels 1–16 are set to be transmitted.

MIDI Receive Settings

The explanations here apply to the RECEIVE page in step 4 on page 136. This determines which parts will receive MIDI data and over which MIDI channels the data will be received.

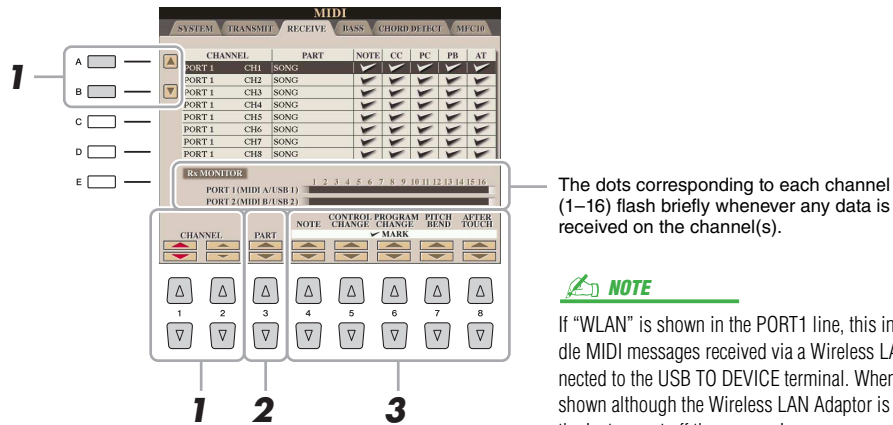

1 Use the [A]/[B] buttons or [1 ▲▼]/[2 ▲▼] buttons to select the channel to be received.

The instrument can receive MIDI messages over 32 channels (16 channels x 2 ports) by USB connection.

2 Use the [3 ▲▼] buttons to select the part via which the selected channel will be received.

The Parts listed on this display are the same as those shown in the MXING CONSOLE display and CHANNEL ON/OFF display with the exception of the following parts.

KEYBOARD

The received note messages control the instrument's keyboard performance.

EXTRA PART 1–4

These are five parts specially reserved for receiving and playing MIDI data. Normally, these parts are not used by the instrument itself. The instrument can be used as a 32-channel multi-timbral tone generator by using these five parts in addition to the other parts (excepting the microphone sound).

3 Use the [4 ▲▼]–[8 ▲▼] button to determine the types of data to be received.

MIDI transmission/reception via the USB terminal and MIDI terminals

The relationship between the [MIDI] terminals and the [USB] terminal which can be used for transmitting/receiving 32 channels (16 channels x 2 ports) of the MIDI messages is as follows:

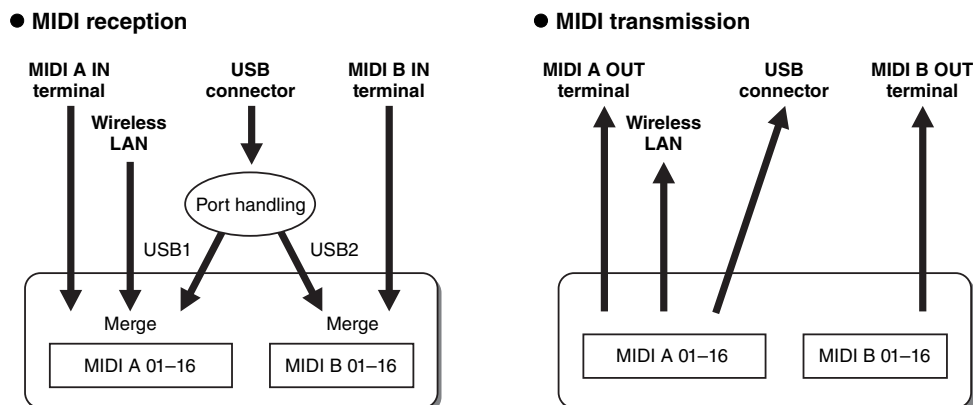

NOTE

The USB wireless LAN adaptor may not be included depending on your locale due to local regulations.

Bass Note Settings for Style Playback via MIDI Receive

The explanations here apply to the BASS page in step 4 on [page 136](#). These settings let you determine the bass note for Style playback, based on the note messages received via MIDI. The note on/off messages received at the channel(s) set to “ON” are recognized as the bass note of the chord of Style playback. The bass note will be detected regardless of the [ACMP] or split point settings. When several channels are simultaneously set to “ON,” the bass note is detected from merged MIDI data received over the channels.

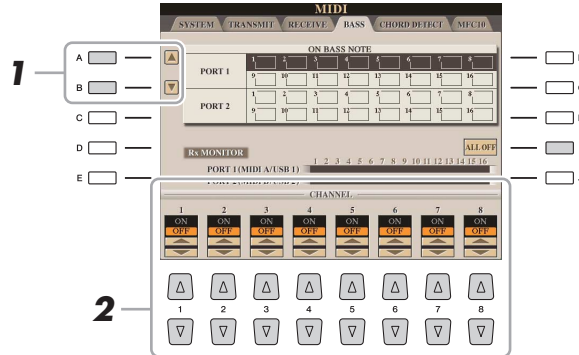

- 1** Use the [A]/[B] buttons to select the desired row of channels.
- 2** Use the [1 ▲▼]–[8 ▲▼] buttons to set specific channels to ON or OFF.
You can also set all channels to OFF by pressing the [I] (ALL OFF) button.

Chord Type Settings for Style Playback via MIDI Receive

The explanations here apply to the CHORD DETECT page in step 4 on [page 136](#). This page lets you select the MIDI channels over which the MIDI data from the external device will be used to detect the Chord Type for Style playback. The note on/off messages received at the channel(s) set to “ON” are recognized as the notes for detecting chords in Style playback. The chords to be detected depend on the fingering type. The chord types will be detected regardless of the [ACMP] or split point settings. When several channels are simultaneously set to “ON,” the chord type is detected from merged MIDI data received over the channels.

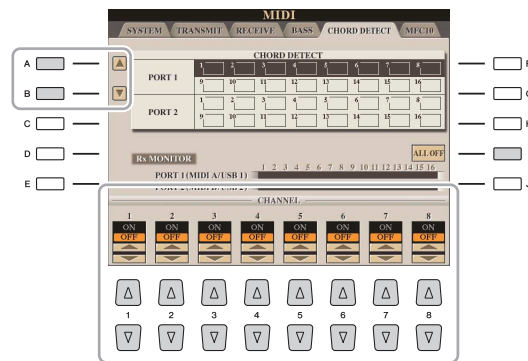

The operation procedure is basically the same as that of the BASS display above.

MFC10 Settings

The explanations here apply to the MFC10 Page in step 4 on [page 136](#).

By connecting an optional MFC10 MIDI Foot Controller to the Tyros5, you can conveniently control a wide range of operations and functions by using your feet—perfect for changing settings and controlling the sound while you perform live. Different functions can be assigned to each of the footswitches and up to five foot controllers (optional) can be connected to the MFC10, for additional sound-shaping possibilities.

- 1 **Connect the MIDI IN terminal of the MFC10 to one of the MIDI OUT terminals of the Tyros5 by using a MIDI cable.**

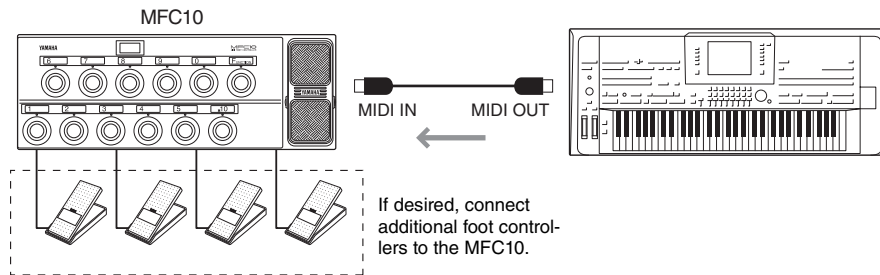

- 2 **Set the MFC10 to the normal mode and turn the [FUNCTION] lamp of the MFC10 on.**
- 3 **Perform steps 1–4 on [page 136](#) to call up the MFC10 Page.**
- 4 **Set the parameters on this display as desired.**

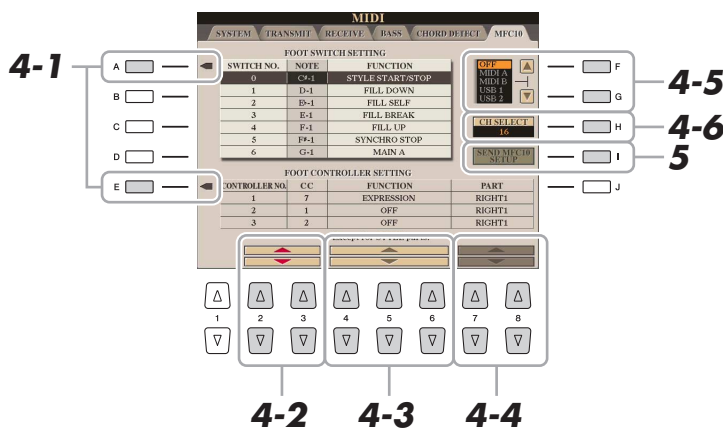

On this display, two settings (below) can be made:

- Each footswitch (F00–F29) on the MFC10 sends a note number to the Tyros5, and the Tyros5 determines how it responds to (which function is executed by) that note number.
- Each foot controller on the MFC10 sends control change messages over a specific control change number to the Tyros5, and the Tyros5 determines how it responds to (which parameter is changed by) that control change number.

4-1 Use the [A]/[E] buttons to select “FOOTSWITCH” or “FOOT CONTROLLER.”

4-2 Use the [2 ▲▼]/[3 ▲▼] buttons to select a footswitch number (F00–F29) or a foot controller number (1–5) to which the function is assigned.

Please note that a note number is assigned to each footswitch and a control change number is assigned to each foot controller beforehand and the settings cannot be changed.

- 4-3** Use the [4 ▲▼]–[6 ▲▼] buttons to specify the function assigned to the footswitch (actually the note number), or the function assigned to the foot controller (actually the control change number). About the functions which can be assigned to the footswitch or foot controller, refer to [page 134](#).
- 4-4** (Only for the FOOT CONTROLLER Setting) Determine the part to which the foot-controller assigned function is applied by using the [7 ▲▼]/[8 ▲▼] buttons.
- 4-5** Use the [F]/[G] buttons to determine the MIDI port which is to be used when communicating with the MFC10.
Here, the USB port (USB1, USB2) can be selected even though the MFC10 does not have a USB connector. This is because a computer can be used instead of the MFC10. (The computer can transmit the same type of data that the MFC10 transmits to the Tyros5. For details, see the bottom of this page.)
- 4-6** Use the [H] (CH SELECT) button to determine the MIDI channel which is to be used when communicating with the MFC10.

5 Press the [I] (SEND MFC10 SETUP) button to send the settings made here to the MFC10.

6 Disconnect the MIDI cable from the Tyros5 and the MFC10, and connect the MIDI OUT terminal of the MFC10 to the MIDI IN terminal of the Tyros5 according to the setting above by using a MIDI cable.

NOTE

Actually the pair of the footswitch number and the note number, the pair of the foot controller number and the control change number, and the MIDI channel for communication set above are transmitted to the MFC10.

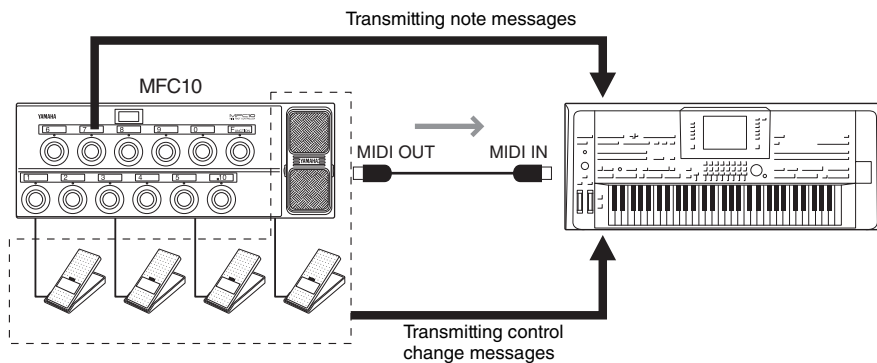

7 Operate the MFC10 to confirm whether you can properly control the Tyros5 from the MFC10 as set in step 4.

8 Press the [EXIT] button to return to the MIDI Template Selection display and save the settings above to the USER tab.

Using a computer or another MIDI instrument instead of the MFC10

Keep in mind that the following two settings on the MFC10 Page are for saving not to the MFC10 but to the Tyros5 as a MIDI template.

- Note number/Tyros5 function assignment pairs
- Control change number/Tyros5 parameter change assignment pairs

If you are not using an MFC10, you can have note numbers and control change messages from any other appropriate MIDI device (such as a computer, sequencer or master keyboard) control the Tyros5. Make sure to set the appropriate channel in this display for control by the external device.

Connecting to a Network (Bundled USB Wireless LAN Adaptor)

The bundled USB Wireless LAN Adaptor lets your Tyros5 connect to a network. This section covers the operations which may be needed to operate the instrument directly on the way of connecting to a network.

For connecting with an iPhone/iPad, see both the [iPhone/iPad Connection Manual](#) and the following instructions.

First, connect the bundled USB Wireless LAN Adaptor to the rear-side [USB TO DEVICE] terminal of Tyros5.

NOTE

Wi-Fi and Wi-Fi Protected Setup are registered trademarks of Wi-Fi Alliance.

NOTE

If the USB wireless LAN Adaptor is not recognized by the instrument, [J] (WIRELESS LAN) button will not appear, even if you press the [FUNCTION] button.

Displaying Available Networks and Making Connections

1 Press the [FUNCTION] button.

2 Press the [J] (WIRELESS LAN) button to call up the available networks in the Wireless LAN display.

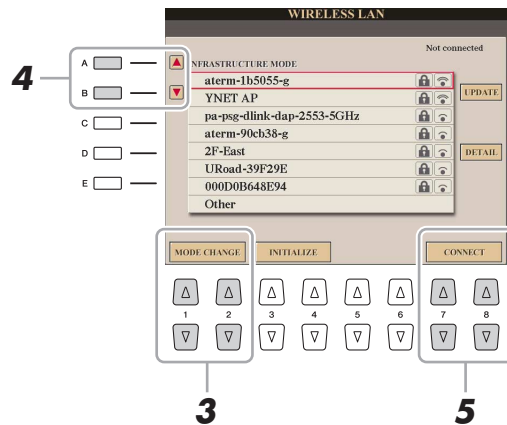

3 Confirm that the MODE parameter is set to “INFRASTRUCTURE MODE.”

If necessary, use the [1 ▲▼]/[2 ▲▼] (MODE CHANGE) buttons to set this to “INFRASTRUCTURE MODE.”

4 Use the [A]/[B] buttons to select the desired network.

5 Use the [7 ▲▼]/[8 ▲▼] (CONNECT) buttons to connect to the selected network.

If necessary, enter the appropriate password.

Entering the SSID, Security and Password Settings in Manual Setup.

- 1 Press the [FUNCTION] button.
- 2 Press the [J] (WIRELESS LAN) button to call up the available networks in the Wireless LAN display.

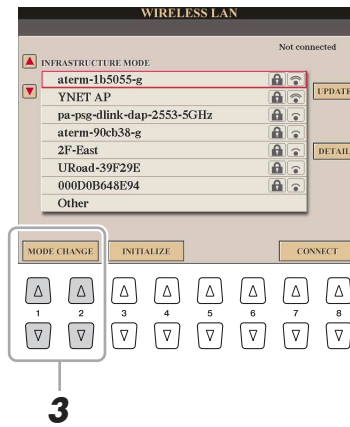

- 3 Confirm that the MODE parameter is set to “INFRASTRUCTURE MODE.”
If necessary, use the [1 ▲▼]/[2 ▲▼] (MODE CHANGE) buttons to set this to “INFRASTRUCTURE MODE.”
- 4 Use the [A]/[B] buttons to select “Other.”

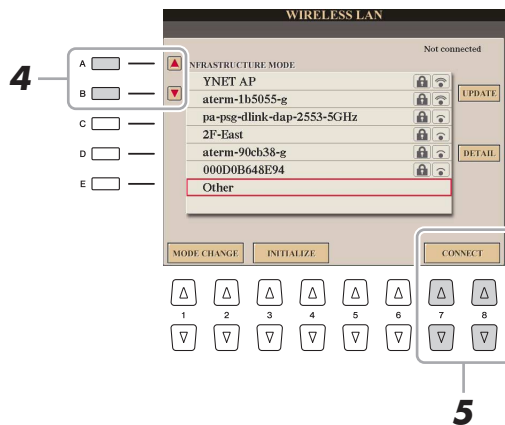

- 5 Use the [7 ▲▼]/[8 ▲▼] (CONNECT) buttons to call up the Manual Setup display.
- 6 Enter the SSID, Security and Password settings for the network.
Use [B] to select SSID, [C] to select Security and [D] to select Password.
- 7 Use the [7 ▲▼]/[8 ▲▼] (CONNECT) buttons to connect to the network.

Starting WPS from the Tyros5

Press and hold the button on the bundled USB Wireless LAN Adaptor until a WPS-related message appears on the Tyros5 display.

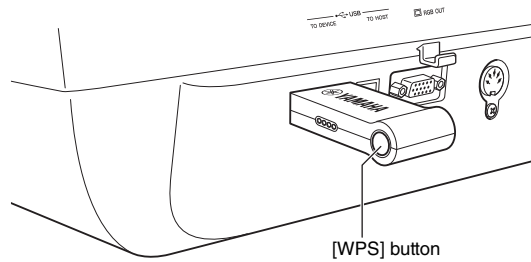

Manually Setting the Access Point Mode

When an available access point cannot be found, you can connect the Tyros5 and the smart device directly.

1 Press the [FUNCTION] button → [J] (WIRELESS LAN) → [1 ▲▼] or [2 ▲▼] (MODE CHANGE).

2 Press the [G] (YES) button.

This calls up the network information on of the Tyros5.

NOTE

To change to the Infrastructure Mode, follow Steps 1 and 2 again.

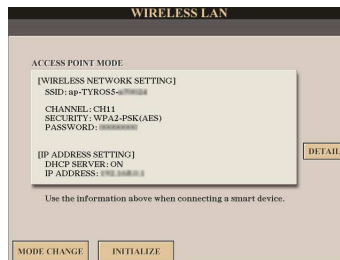

3 If necessary, press the [I] (DETAIL) button and enter the SSID, Security and Password settings.

Use the [B] (SSID) button, [C] (SECURITY) button and [D] (PASSWORD) button to enter each setting.

4 Press [7 ▲▼] or [8 ▲▼] (SAVE) button and follow the onscreen instructions.

The Tyros5 is now available as an access point.

Setting the Time Zone

Once the instrument has accessed the network via the USB Wireless LAN Adaptor, the current time is shown on the display.

You can set the Time Zone and Daylight Saving Time for your local time.

1 Press the [FUNCTION] button → [J] (WIRELESS LAN) → [I] (DETAIL).

2 Use the TAB [◀][▶] buttons to call up the “OTHERS” display.

3 Select your Time Zone and set the Daylight Saving Time.

Use [B] to select the Time Zone, and [C] to set the Daylight Saving Time.

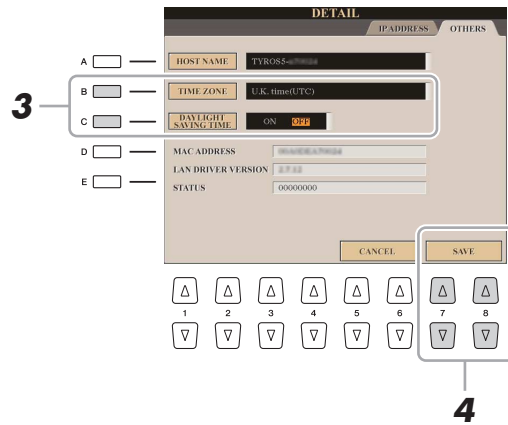

4 Press one of the [7 ▲▼] or [8 ▲▼] (SAVE) buttons and follow the onscreen instructions.

Expansion Pack Related Operations

Installing an Expansion Pack lets you add a variety of optional contents such as Songs, Styles, Voices and so on to the “Expansion” folder in the HD1 drive. You can install the Expansion Pack in two different ways—using a USB flash memory or via wireless network. This section covers the operations which may be necessary to add new contents to the instrument.

For overall general instructions, access the Tyros5 page at the Yamaha Music Soft website:

<http://www.yamahamusicsoft.com>

The following two instructions are not necessary when you install the Expansion pack via wireless network.

Saving the Instrument Info File to the USB Flash Memory

In order to get the Expansion Pack data for the Tyros5, you’ll need to retrieve the Instrument Info file from the Tyros5 as described below.

- 1** Connect the USB flash memory to the [USB TO DEVICE] terminal.
- 2** Call up the OWNER display.
[FUNCTION] → [H] UTILITY → TAB[◀][▶] OWNER
- 3** Press the [E] (EXPORT INSTRUMENT INFO) button.
- 4** Follow the onscreen instructions.

This saves the Instrument Info file to the root directory in the USB flash memory.

Installing the Expansion Pack Data from the USB Flash Memory

Follow these instructions to install Expansion Pack data from the USB flash memory.

- 1** Connect the USB flash memory in which the Pack data are saved to the [USB TO DEVICE] terminal.
- 2** Press the [FUNCTION] button.
- 3** Press the [I] (PACK INSTALLATION) button.
- 4** Use the [A]–[J] and [1 ▲]–[6 ▲] buttons to select the desired Pack file.
- 5** Press the [6 ▼] (INSTALL) button.
- 6** Follow the onscreen instructions.

This installs the selected Pack data to the “Expansion” folder in the HD1.

Uninstalling the Expansion Pack data.

You can uninstall the Expansion Pack data by Factory Reset FILES & FOLDERS (see [page 131](#)).

Index

Symbols

+Audio 25

Numerics

3-BAND EQ (Microphone Setting)..... 102

A

A.T. (After Touch) 73
A*A (Ensemble Voice) 21
A*D (Ensemble Voice)..... 21
ACCENT TYPE 40
Access Point Mode..... 146
AEM Technology 6
AFTER TOUCH 7, 14
AI FINGERED 27
AI FULL KEYBOARD 27
AMPLITUDE 13–14
Any Key 57
ARABIC 1/2 10
ASSIGN (Harmony/Echo)..... 8
ASSIGN / HARMONY
(Ensemble Voice) 20
Assignable Pedal Functions 134
ATTACK 14
ATTACK (Voice Set)..... 14
ATTACK PITCH ADJUST TIME
(Ensemble Voice) 24
ATTACK PITCH RANGE
(Ensemble Voice) 24
Audio File..... 80–81
Audio part 31
AUTO..... 86
AUTO mode..... 86
Auto Power Off (Utility) 127

B

Backup/Restore 132
BAR 61, 72
BAR CLEAR 41
BAR COPY 41
BASS (MIDI) 136
Bass Note Settings 141
BEAT 61, 72
BEAT CONVERTER..... 39
BOOST/CUT..... 40
BRIGHT (Brightness)..... 14

C

CANCEL 72
CARRIER parameters
(Synth Vocoder)..... 113
CH.Vol 73
CHANNEL 40–41, 70
CHANNEL TRANSPOSE 71
Chord..... 73
CHORD DETECT (MIDI) 136
Chord Events..... 73
Chord Fingering..... 26

Chord Fingering Types 27
CHORD NOTE ONLY (Harmony/Echo).... 8
Chord Tutor 26
Chord Type Settings 141
Chorus (Mixing Console) 118
CHORUS DEPTH (Voice Set) 15
CLOCK..... 61, 72
Clock setting (MIDI) 138
Code 73
COMMON (Voice Set) 13
COMPARE 12
CONFIG 1 126
CONFIG 2 128
Connections 133
CONTROLLER 7, 11
CONTROLLER (Voice Set)..... 13
Converting..... 80
Cool! (Voice) 5
COPY 72, 90
Copy (Multi Pad) 49
Ctrl (Control Change)..... 73
CUT..... 72, 90

D

DATA ENTRY 72
DECAY (Voice Set)..... 14
DELETE 61, 71–72, 90
DETAIL (Synth Vocoder) 111
DETAIL (Vocal Harmony) 106
DETUNE (Vocal Harmony) 109
Displaying Available Networks 144
Display-related settings /
Voice Category Button Options
(Utility) 128
Drums (Voice) 5
DSP 15
DSP DEPTH (Voice Set)..... 15
DSP1 (Mixing Console)..... 118
DSP2-9 (Mixing Console) 118
DYNAMICS 40

E

EA (Ensemble Voice)..... 21
Echo Types (Harmony/Echo) 9
Edit (Multi Pad) 48
EFFECT Parameters 118
EFFECT parameters (Synth Vocoder) .. 113
EFFECT/EQ (Voice Set) 15
EG (Voice Set) 14
Ensemble Voice 19
Ensemble Voice Key Assign Status List .21
Ensemble Voice Key Assign Type List ...21
Ensemble Voice Key Assignment
Structure..... 20
Envelope Generator..... 14
EQ (Voice Set) 15
EQ Parameters 122
EQUAL (SCALE TUNE) 10
Event List display 72
EXPAND/COMP. 40

Expansion Pack..... 148

F

F*A (Ensemble Voice) 21
F*D (Ensemble Voice)..... 21
Factory Reset 131
Fade In/Out (Utility) 126
Favorite Record 91
FILES..... 90
FILTER 13–14, 72
FILTER Parameters..... 116
FINE 39
Fine-tuning..... 10
FINGERED 27
FINGERED ON BASS 27
FINGERED* 27
Follow Lights..... 57
FOOTAGES (Organ World)..... 17
Footswitch/Foot Controller Settings..... 133
FORMANT (Vocal Harmony)..... 109
FORMANT parameters
(Synth Vocoder)..... 113
Free Play 25
Freeze 96
FULL KEYBOARD 27

G

GM..... 6
GROOVE..... 39
Guide 55

H

HARMO. (Harmonic Content)..... 14
HARMONY (Ensemble Voice)..... 20
Harmony Types (Harmony/Echo) 9
Harmony/Echo..... 8
HI (Ensemble Voice)..... 21
HIGH KEY 45
HPF parameters (Synth Vocoder) 113
HUMANIZE (Ensemble Voice) 24

I

INITIAL TOUCH..... 7
INS (INSERT) 72
INSERT 90
Installing the Expansion Pack..... 148
Instrument Info File..... 148

J

Jump Markers..... 75

K

KBD.VEL 61
Key (Key signature)..... 73
KEY ASSIGN TYPE 20
Key Assign Type..... 21

Key Assignment Status	20
Key Assignment Structure	20
Key off retrigger	21
KEYBOARD (Transpose)	11
KEYBOARD/PANEL	7, 11
KIRNBERGER	10

L

LA (Ensemble Voice)	21
LENG (Length)	18
LFO	13–14
Line Out (MAIN) / Screen (Utility)	128
Line Out Settings	124
Live! (Voice)	4
Live! Drums (Voice)	5
Live! SFX (Voice)	5
LO (Ensemble Voice)	21
Local Control (MIDI)	138
Loop End Marker	75
Loop Recording	33
Lyrics	73
Lyrics display	53
Lyrics Events	73

M

MANUAL	86
Manual Setup	145
MARK	71, 90
MASTER (Transpose)	11
Master Compressor Settings	123
MASTER EQ (Mixing Console)	122
MEAN-TONE	10
MEDIA	129
MEGAEnhancer	5
MegaVoice (Voice)	5
MERGE	85
MESSAGE SW (MIDI)	138
Meta event	73
Metronome (Utility)	126
MFC10 (MIDI)	136
MFC10 Settings	142
Microphone	100
Microphone Settings	101
MIDI Receive Settings	140
MIDI Settings	136
MIDI Song Data Structure	59
MIDI Songs	50
MIDI System Settings	138
MIDI Templates	137
MIDI Transmit Settings	139
MIX	71
Mixing Console	115
MODE (Organ World)	18
MODULATION (Voice Set)	13
MONO/POLY (Voice Set)	13
MOVE Up/Down	90
Multi Assign Type (Harmony/Echo)	9
MULTI FINGER	27
Multi Pad	46
Multi Pad Creator	46
MULTI SELECT	72
Multi Track	76
Multi Track File	76
Music Finder	91
Music Finder File	93

Music Notation	51
----------------------	----

N

Name	73
Network	144
NOISE GATE (Microphone Setting)	102
NORMAL REC	84
Normalize	83
Note	73
Note Events	73
NOTE LIMIT	45
NTR (Note Transposition Rule)	44
NTT (Note Transposition Table)	44

O

OCTAVE (Ensemble Voice)	23
One Touch Setting	30
OnOff	73
Organ Flutes (Editing Organ Voices)	17
Organ Flutes (Organ World)	17
Organ Flutes! (Voice)	5
Organ World	17
ORIGINAL BEAT	39
OTS LINK TIMING	28
Overdub Recording	33
OVERVIEW (Synth Vocoder)	111
OVERVIEW (Vocal Harmony)	106
OWNER	130

P

P.Bnd (Pitch Bend)	73
PAN (Vocal Harmony)	109
PANEL SUSTAIN (Voice Set)	15
PANPOT (Ensemble Voice)	23
Parameter Lock (Utility)	127
PART (Vocal Harmony)	106
PART EQ (Mixing Console)	122
PART OCTAVE (Voice Set)	13
PART ON/OFF	29
PART ON/OFF (Ensemble Voice)	23
Password	145
PASTE	72
PEDAL	86
PEDAL PUNCH IN/OUT	67
Performance Assistant Technology	58
PITCH CORRECT MODE (Vocal Harmony)	110
PITCH DETECT (Microphone Setting)	102
PITCH RANGE (Ensemble Voice)	24
Playlist	88
PLUS PLAYBACK	84
PORTAMENTO TIME (Voice Set)	13
Pro	25
Prog (Program Change)	73
PROPERTY	89
Prot.1	50
Prot.2	50
Prot.2 Orig.	50
Protected Songs	50
Punch In	67
PUNCH IN OUT	85
Punch In/Out	67
Punch Out	67
PURE MAJOR	10

PURE MINOR	10
PYTHAGOREAN	10

Q

QUANTIZE	41, 70
----------------	--------

R

Realtime Recording	33, 46, 59
Realtime Recording (Multi Pad)	46
REC END	67
REC START	67
RECEIVE (MIDI)	136
Recording Chords (Step Recording)	64
Recording Melodies (Step Recording)	60
Recording Part	59
Redo	77
Registration Memory	95
Registration Sequence	97
RELES. (Release) (Voice Set)	17
REMOVE EVENT	41
REPEAT	89
Repeat	55
RESP (Response) (Organ World)	18
Retrigger	21
Reverb (Mixing Console)	118
REVERB DEPTH (Ensemble Voice)	23
REVERB DEPTH (Voice Set)	15
Rotary Speaker	17
RTG (Ensemble Voice)	21
RTR (Retrigger Rule)	45

S

S.Art! (Voice)	4
S.Art2 Auto Articulation (Utility)	128
S.Art2! (Voice)	4
S.Vol	73
SAVE	72
Scale Tune	10
Scale types	10
ScBar (Score Start Bar)	73
Sect	73
SECTION SET	29
Security	145
SELECT	71, 90
SEQUENCE END	98
Session	25
SETUP	71
SFX (Voice)	5
SHUFFLE	89
SINGLE FINGER	27
SIZE	70
SOFT (Touch)	7
Song	50
SONG (Transpose)	11
Song Creator	59
Song Position Markers	75
SORT	89
SOUND (Voice Set)	14
SOURCE (PLAY) ROOT/CHORD	43
SPEED (Harmony/Echo)	8
SSID	145
Staccatissimo	61
Staccato	61
Start/End Points	87

Step Recording	37, 48, 59
Step Recording (Multi Pad)	48
STOP ACMP	28
STRENGTH	40, 70
Style	25, 73
Style Assembly	37
Style Creator	31
Style Data Structure	31
STYLE TOUCH	29
Style Types	25
Super Articulation (Voice)	4
Super Articulation2 (Voice)	4
Sweet! (Voice)	5
SWING	39
SYNCHRO STOP WINDOW	28
Synth Vocoder Types	111
SYS/EX	73
SYS/EX. (System Exclusive)	73
SYSTEM (MIDI)	136
System Exclusive	72
System Exclusive Events	73
SYSTEM RESET	131

T

Talk	100
TALK MIXING (Microphone Setting)	103
Tap (Utility)	127
TEMPO	29
Tempo	73
Tenuto	61
Text display	53
THRU (Ensemble Voice)	21
Time (Time signature)	73
Time Zone	147
TIMING (Ensemble Voice)	24
TOUCH LIMIT (Harmony/Echo)	8
Touch Response	7
TOUCH SENSE (Voice Set)	13
TRANSMIT (MIDI)	136
TRANSCOPE (Vocal Harmony)	109
TRANSCOPE ASSIGN	11
TREMOLO (Organ World)	17
TUNE / EFFECT (Ensemble Voice)	23
TUNE Parameters	117
Tuning	10
TUNING (Ensemble Voice)	23

U

Undo	77
UNDO/REDO	89
Up/Down	90
USB Wireless LAN Adaptor	144
USER MEMORY (Microphone Setting)	101
Utility	126

V

VARIATION (DSP)	15
VELOCITY CHANGE	41
VIBRATO (Organ World)	17
VIBRATO (Voice Set)	15
VIBRATO SENSITIVITY (Ensemble Voice)	24
VIBRATO SPEED (Organ World)	18

Vocal Harmony	100
Vocal Harmony Types	104, 106
VOCODER parameters (Synth Vocoder)	113
VOICE (Ensemble Voice)	23
Voice Set	12
Voice Types	4
VOL (Organ World)	18
VOLUME (Ensemble Voice)	23
VOLUME (Harmony/Echo)	8
VOLUME (Vocal Harmony)	109
VOLUME (Voice Set)	13
VOLUME / PAN (Ensemble Voice)	23
Volume Balance	78, 83
VOLUME&ATTACK (Organ World)	18

W

WERCKMEISTER	10
Wireless LAN Adaptor	144
WPS	146

X

XG	6
XGPrm (XG parameters)	73

Y

Your Tempo	57
------------	----