

Read this first

In order to use the complete and customizable ADECIA communications solutions, it is necessary to update the firmware of the devices. Please download the latest firmware from the website below and update accordingly.

In order to use the easy RADIUS security configuration feature added in ADECIA version 2.5, a firmware update for the network switch (SWR2311P-10G) is also required.

U.S.A. and Canada: <https://uc.yamaha.com/support/>

Other countries: <https://download.yamaha.com/>



SIGNAL PROCESSOR

RM-CR

Reference Manual

CONTENTS

Information.....	3
INTRODUCTION.....	3
Available utility software	3
Available manuals.....	4
SETUP	5
Connecting to peripheral devices	5
Easy setup using the Web GUI Device Manager	8
CONTROLS AND FUNCTIONS	17
Front panel.....	17
Rear panel	18
CONNECTING COMMUNICATION DEVICES	19
Connecting a computer.....	19
Connecting a smartphone.....	22
Connecting a video conferencing system	23
CONNECTING EXPANSION DEVICES	24
Connecting a handheld microphone	24
Connecting a speaker with built-in amplifier	24
AVAILABLE UTILITY SOFTWARE.....	25
Starting up the Web GUI Device Manager	25
Using ProVisionaire Control.....	27
APPENDIX	28
Block diagram	28
Alert log list	29
EXPLANATIONS	33
About configuration files and presets.....	33
About Divide/Combine Room	35
About deployment servers	36
About microphone grouping.....	37
About network security and easy RADIUS security configuration	38
About VoIP calls	40
About SNMP/MIB.....	41
About Dante.....	42
Updating the firmware.....	42
Initializing RM series devices.....	43
Updating the network switch (SWR2311P-10G) and initializing it for ADECIA.....	43
MAIN SPECIFICATIONS	44

Information

- The illustrations and images shown in this manual are for instructional purposes only.
- The company names and product names in this manual are trademarks or registered trademarks of their respective companies.
- We are continuously improving the software for our products. The latest version can be downloaded from the Yamaha website.
- This document is based on the latest specifications at the time of publication. The latest version can be downloaded from the Yamaha website.
- Reproduction of this manual in whole or in part without permission is prohibited.

INTRODUCTION

Thank you for purchasing the Yamaha RM-CR signal processor.

This unit is one of the components of ADECIA, a comprehensive remote conferencing solution, as well as a signal processor that processes the audio for remote conferences held in meeting rooms.

“ADECIA” is a general term for three solutions that differ depending on the model of microphone used.

- **ADECIA ceiling solution:**

This solution uses the ceiling-mounted microphone RM-CG.

- **ADECIA tabletop solution:**

This solution uses the wired microphone RM-TT, which is installed on a table.

- **ADECIA wireless solution:**

This solution includes a wireless microphone, access point, battery and charger.

For correct and safe use of this product, be sure to first read this manual carefully together with the RM-CR Installation Manual (included with the product).

Available utility software

This utility software can be used to set up this unit according to its use and environment.

- | | |
|--|---|
| <input type="checkbox"/> Web GUI “RM-CR Device Manager” | This allows you to use a computer browser to configure and operate this unit. |
| <input type="checkbox"/> RM Device Finder | This is application software for controlling ADECIA devices on the network. It detects the ADECIA devices on the network and displays the Device Manager for each device. It can also be used to update the firmware of each device, specify the divide/combine settings for multiple rooms, and select a preset. |
| <input type="checkbox"/> ProVisionaire Design | This is Windows application software for designing and managing an entire sound system made up of a combination of various devices. |
| <input type="checkbox"/> ProVisionaire Control | This is Windows application software that allows you to remotely control parameters for various devices from a single control panel. Template files for controlling the route of conference calls using the RM series can be downloaded from the RM-CR website. |
| <input type="checkbox"/> ProVisionaire Touch | This is iPad application software that allows you to remotely control parameters for various devices from a single control panel. |

Available manuals

This describes the manuals related to this product.

- | | | |
|-------------------------------------|---|--|
| <input type="checkbox"/> | Installation Manual (included) | This contains the precautions for using this unit safely as well as the installation procedure. |
| <input checked="" type="checkbox"/> | Reference Manual (this manual/PDF) | This provides details on connecting and using this unit. |
| <input type="checkbox"/> | Web GUI Device Manager Operation Guide | This provides details on the Web GUI Device Manager, which allows you use your computer to configure and operate this unit.
There are two types: one for RM-CR/RM-CG/RM-TT and one for the RM-W series. |
| <input type="checkbox"/> | RM Series Remote Control Protocol Specifications | This provides details on command information for acquiring and controlling information about this unit from external devices. |
| <input type="checkbox"/> | ProVisionaire Design User Guide | This provides details on using ProVisionaire Design. |
| <input type="checkbox"/> | ProVisionaire Control Setup Guide | This provides details on using ProVisionaire Control. |

Software and manuals related to this product can be downloaded from the following website.

▼ Yamaha website (Downloads)

U.S.A. and Canada:

<https://uc.yamaha.com/support/>

Other Countries:

<https://download.yamaha.com/>

SETUP

In order to use this unit, setup is required. First connect this unit to peripheral devices, and then set it up using the Web GUI “RM-CR Device Manager”.

Connecting to peripheral devices

ADECIA uses PoE or PoE+ as the system for supplying/receiving power. In addition, Dante is used as the connection format. Refer to the diagrams in this manual to connect this unit to peripheral devices with LAN cables.

- NOTICE:**
- When disconnecting the LAN cable from the Dante/PoE port, wait at least five seconds before reconnecting the cable. Otherwise, damage or malfunctions may result.
 - With a Dante network, do not use the EEE function* of the network switch. The EEE function may degrade clock synchronization performance and interrupt the audio. Therefore, please note the following.
 - When using managed switches, turn off the EEE function on all ports used for Dante. Do not use a switch that does not allow the EEE function to be turned off.
 - When using unmanaged switches, do not use switches that support the EEE function. In such switches, the EEE function cannot be turned off.
 - * EEE (Energy-Efficient Ethernet) function: Technology that reduces the power consumption of Ethernet devices during periods of low network traffic; also known as Green Ethernet or IEEE802.3az.
 - Before connecting ADECIA to a core network, consult with your network administrator.

■ For an ADECIA ceiling solution

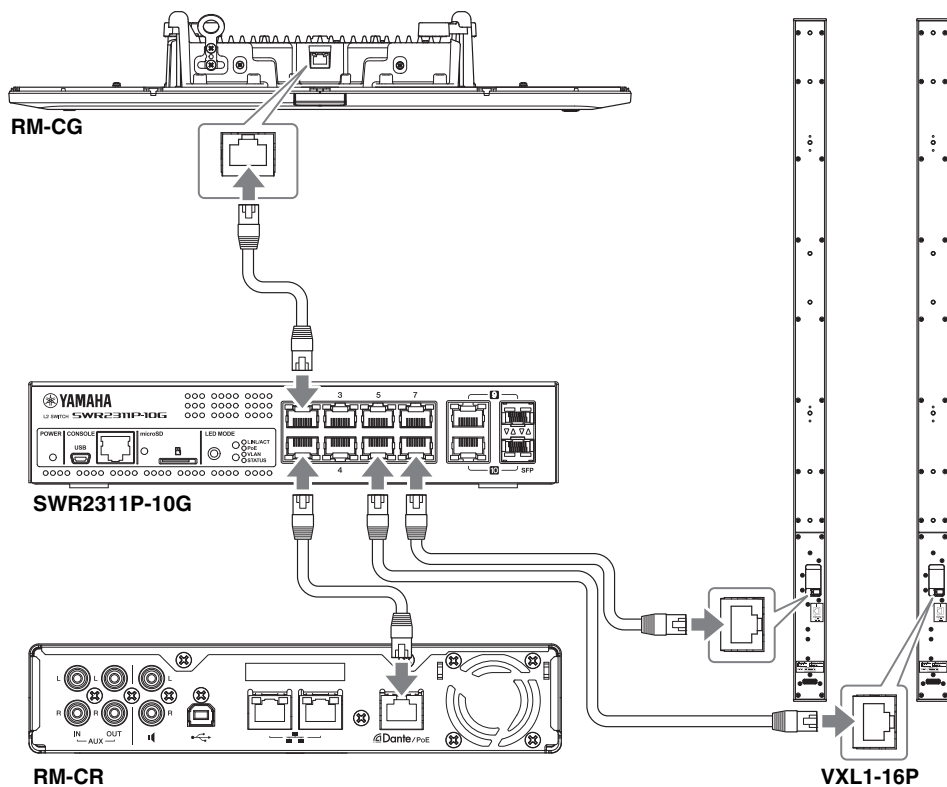

IMPORTANT: There is a DIP switch for specifying settings on the back of each VXL1-16P. Before plugging in LAN cables, set the DIP switches as shown below. The DIP switch settings on the two units must not be the same.

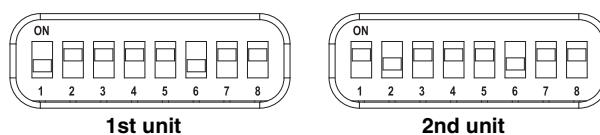

■ For an ADECIA tabletop solution

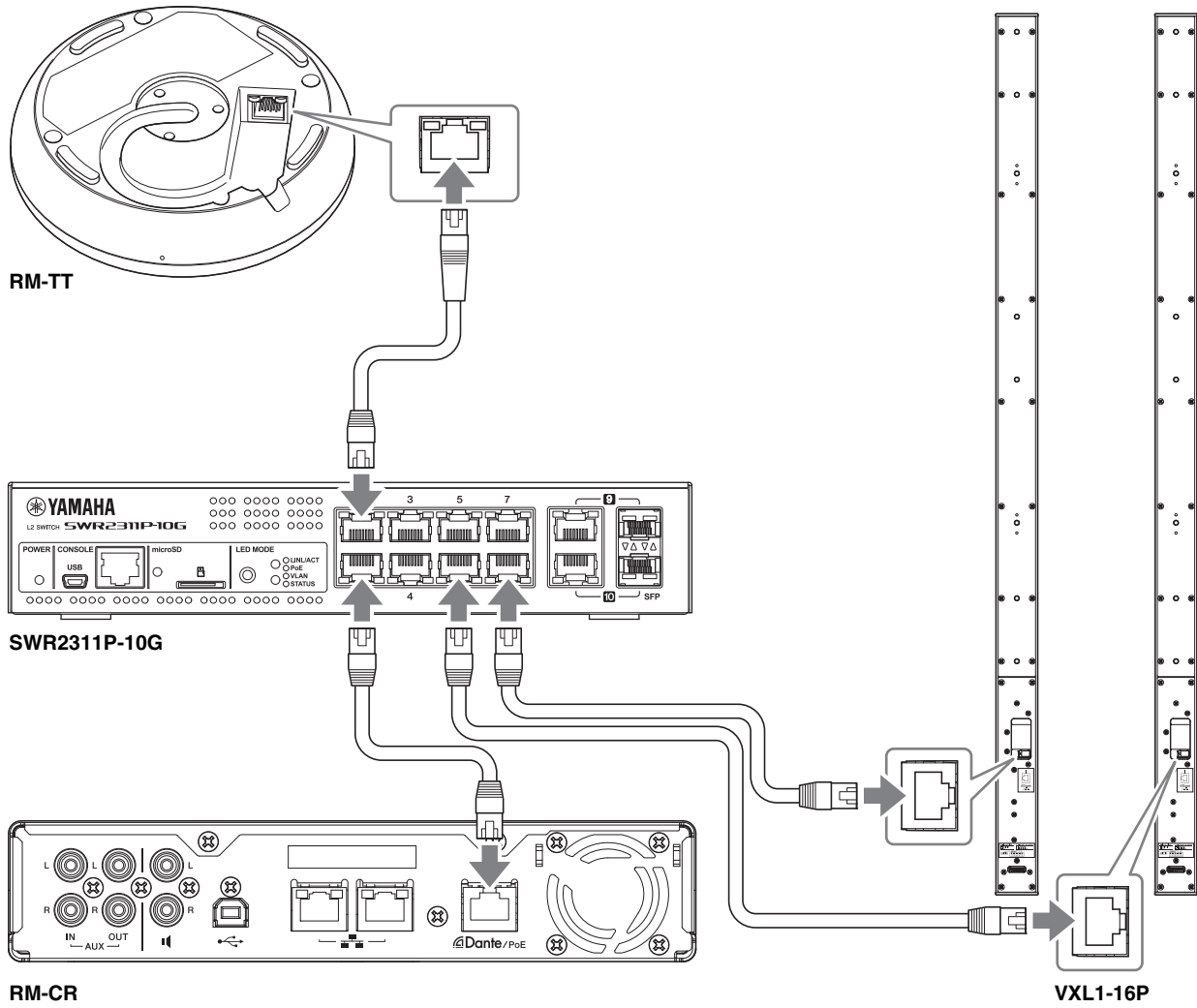

IMPORTANT: There is a DIP switch for specifying settings on the back of each VX1-16P. Before plugging in LAN cables, set the DIP switches as shown below. The DIP switch settings on the two units must not be the same.

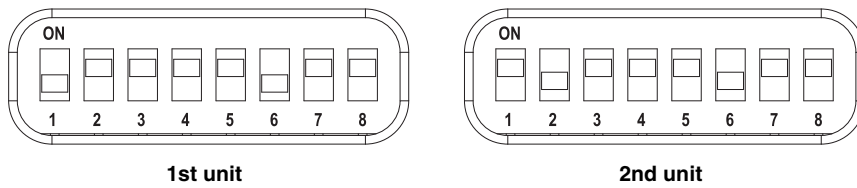

■ For an ADECIA wireless solution

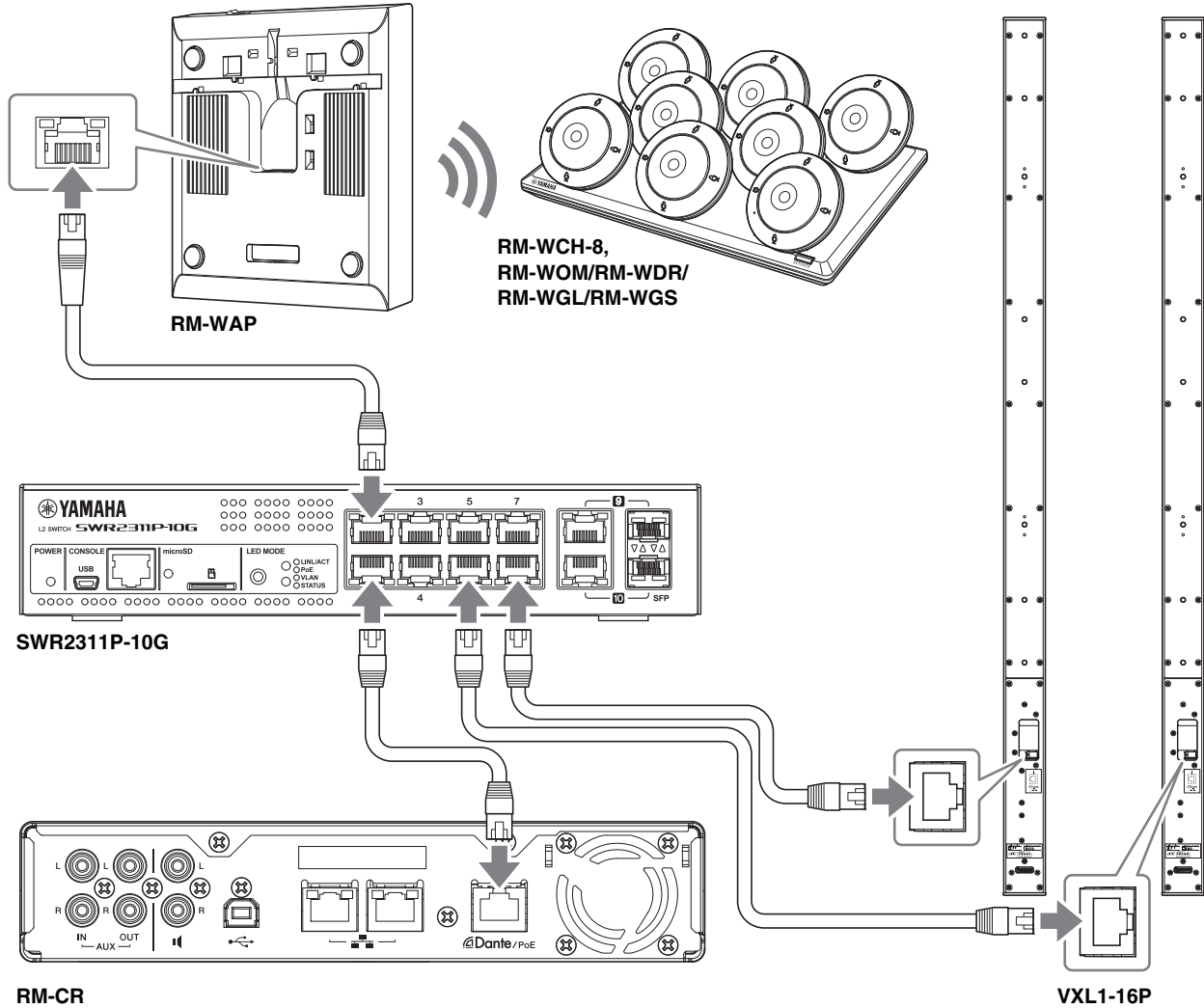

IMPORTANT: There is a DIP switch for specifying settings on the back of each VXL1-16P. Before plugging in LAN cables, set the DIP switches as shown below. The DIP switch settings on the two units must not be the same.

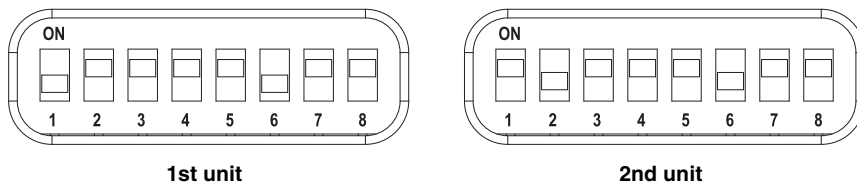

Before setting up this unit:

With an ADECIA wireless solution that includes RM-WAP, use the SITE SURVEY function of the Web GUI “RM-WAP Device Manager” to check the signal conditions in the area before setting up this unit. For details, refer to “Installation and Setup” in the Reference Manual for the RM Series Wireless Microphone System.

Easy setup using the Web GUI Device Manager

After connecting this unit to peripheral devices, set it up using the Web GUI “RM-CR Device Manager”.

Prepare the following.

- Computer
- A-micro B type USB cable (included with the unit)

1. Make sure that this unit and all peripheral devices have been turned on.

2. Connect this unit and the computer with an A-micro B type USB cable.

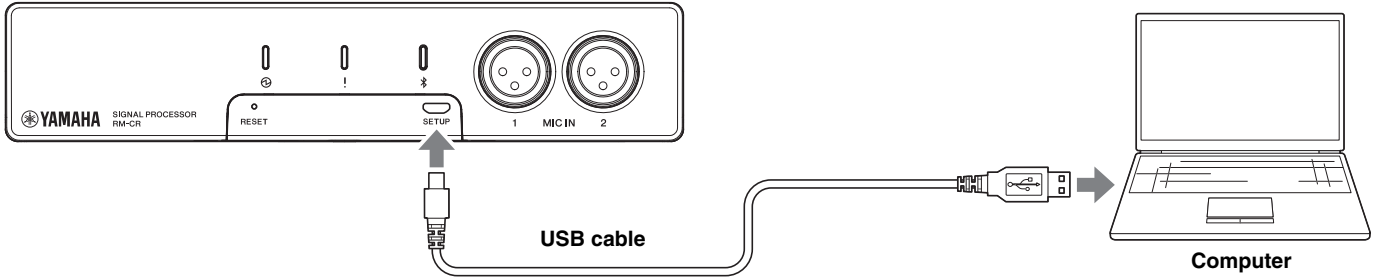

3. Start a browser (Google Chrome or Safari) on the computer and type “172.16.0.1” in the address bar.

The first login window of RM-CR Device Manager appears.

4. Click the [SIGN UP] button in the first login window.

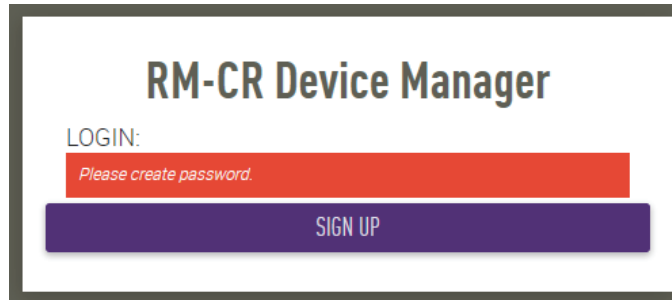

5. Specify a password in the password settings window, and then click the [SUBMIT] button.

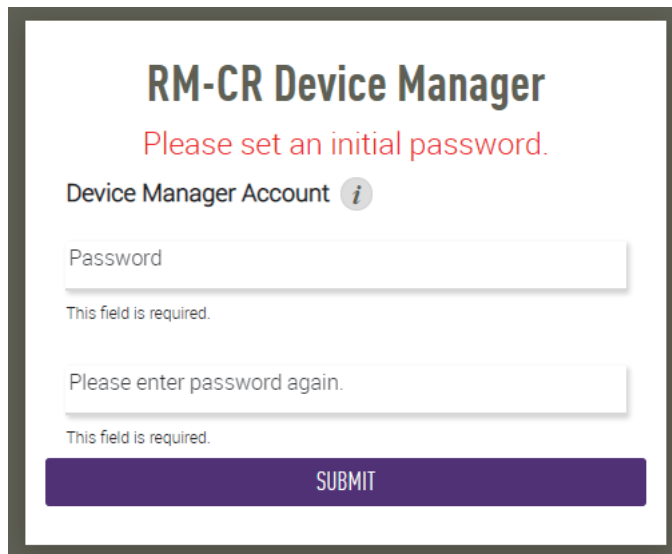

6. Type the password into the login window, and then click the [LOGIN] button.

The wizard starts up.

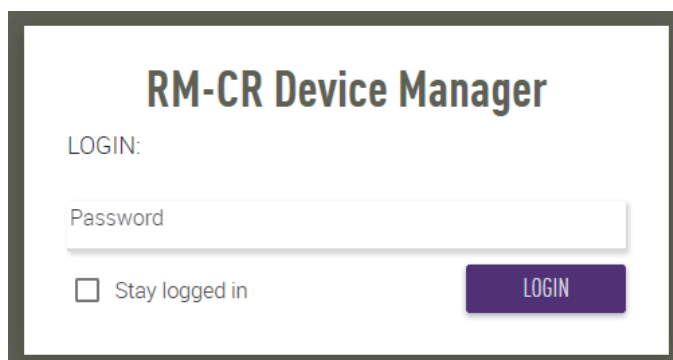

7. Follow the wizard's instructions to continue the setup.

[1. WELCOME]

Click the [NEXT] button.

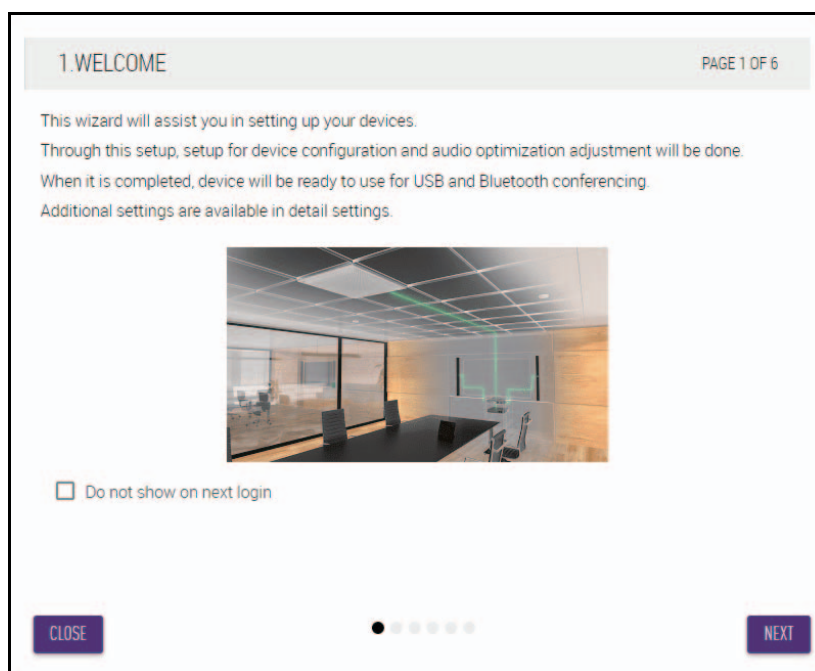

[2. REGISTER YOUR PERIPHERAL DEVICE]

① Click the [ENABLE ALL & SEARCH] button.

Peripheral devices are detected and displayed in the list.

NOTE: If no peripheral devices are detected, recheck the LAN cable connections. For VXL1-16P units, recheck the DIP switch settings. (Refer to page 7.)

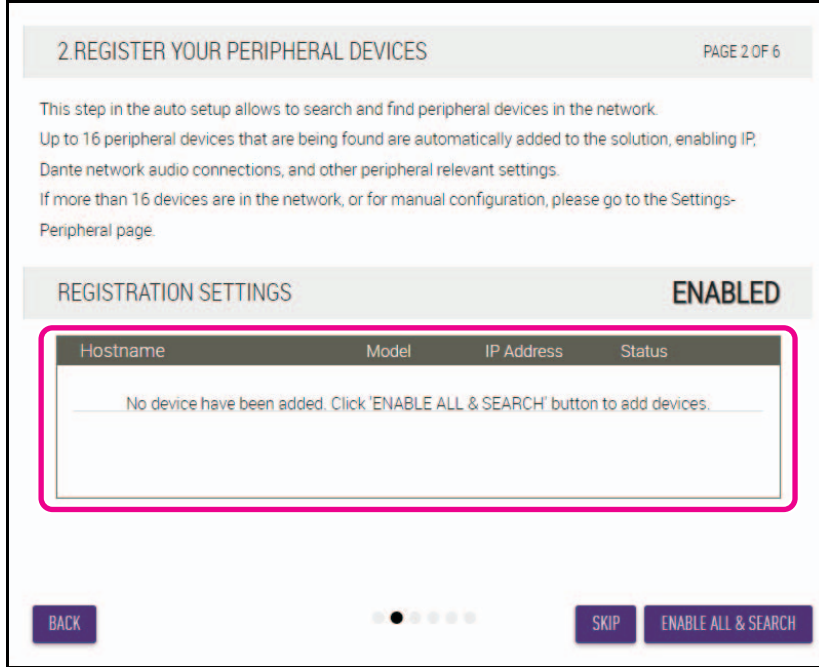

② Check that [connected] appears below [Status] for all peripheral devices, and then click the [NEXT] button.

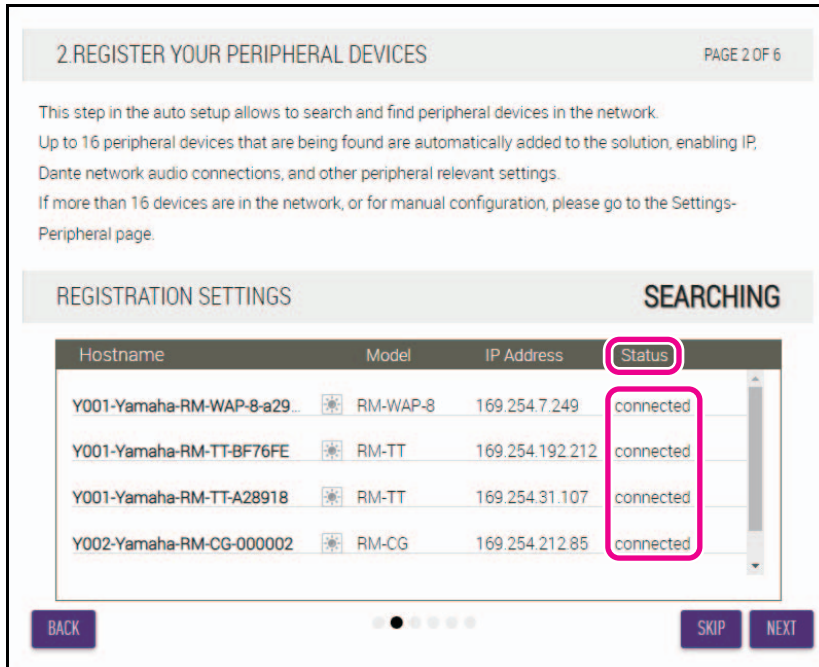

NOTE: Items [2-1] to [2-3] below appear only in an ADECIA wireless solution that comprises RM-W.

[2-1. CHECKING WIRELESS ENVIROMENT]

Peripheral devices are detected by RM-WAP and displayed in the list.

Click the [NEXT] button.

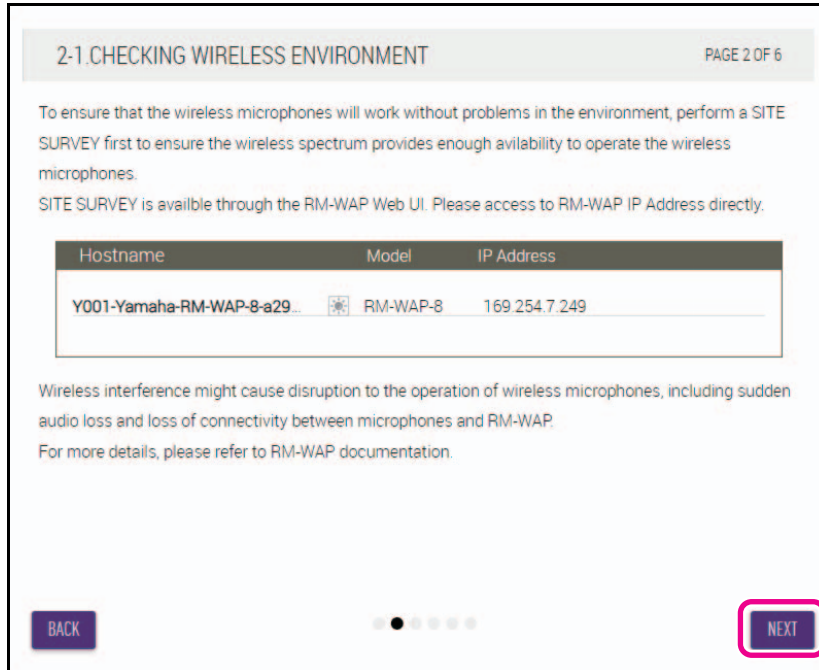

[2-2. PAIR CHARGERS WITH RM-WAP]

Pair the RM-WAP and charger.

- ① Select the RM-WAP, and then click the [PAIR] button.
- ② Long-press the PAIR button on the RM-WCH for at least two seconds.
- ③ Click the [NEXT] button.

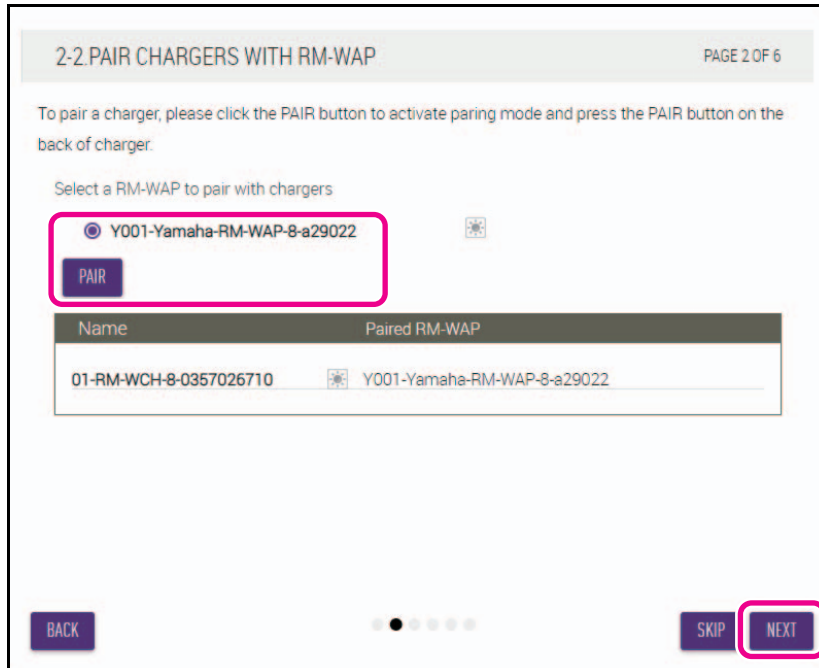

[2-3. PAIR MICHROPHONE WITH RM-WAP]

Pair the RM-WAP and wireless microphones.

IMPORTANT: Place all wireless microphones on the charger.

- ① Select the RM-WAP, and then click the [PAIR] button.
- ② Long-press the ACTIVATE button on the RM-WCH for at least two seconds.
- ③ Click the [NEXT] button.

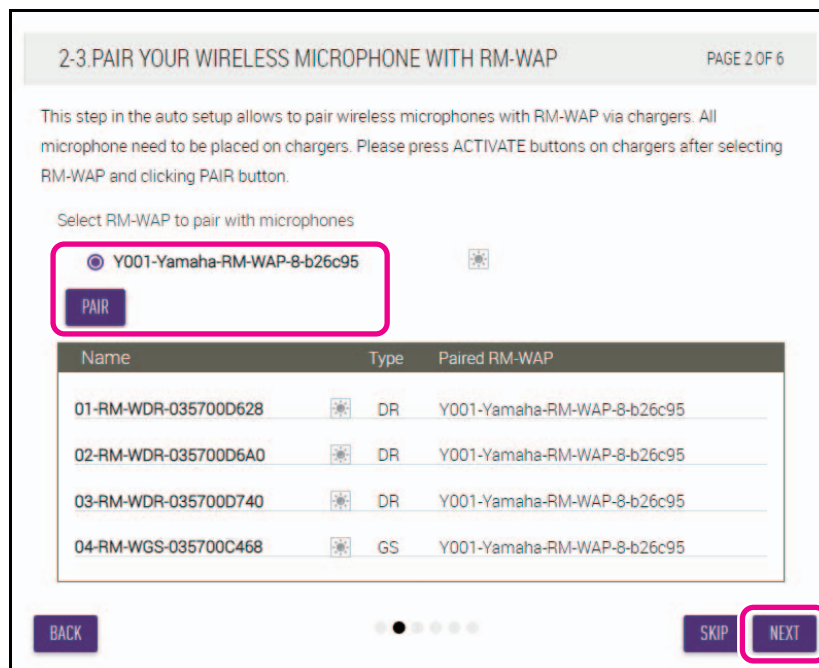

[3. CHECK FIRMWARE VERSION]

Check the versions of the firmware, and then click the [NEXT] button.

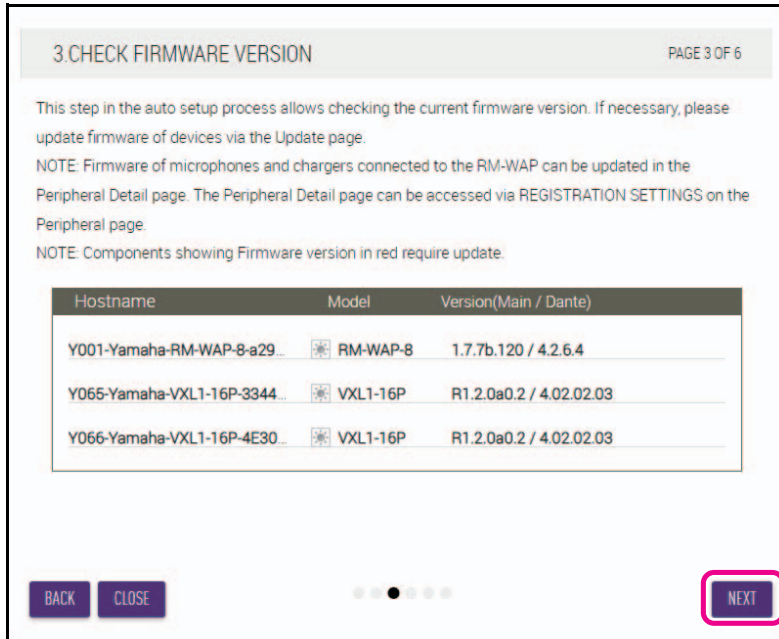

NOTE: If the firmware must be updated, the version number appears in red.

Update the firmware of RM-CR, RM-CG, RM-TT, RM-WAP and VXL1-16P via [TOOLS]→[Update]→[FIRMWARE UPDATE] in the Web GUI “RM-CR Device Manager”.

Update the firmware of RM-WCH, RM-WOM, RM-WDR, RM-WGL and RM-WGS via [SETTINGS]→[Peripheral]→[REGISTRATION SETTING]→[VIEW] under “Details”→[FIRMWARE UPDATE] in the Web GUI “RM-CR Device Manager”. After updating the firmware, click [AUTO SETUP] (in the menu bar of the Web GUI “RM-CR Device Manager”) to perform the auto setup process again.

[4. LOCATE PERIPHERAL DANTE SPEAKERS]

Set [Position] for each speaker to [Left] or [Right] according to the actual mounting position, and then click the [NEXT] button.

NOTE: If  (Identify button) on the right below [Hostname] is clicked, the indicator on the corresponding speaker flashes, allowing you to confirm the mounting position.

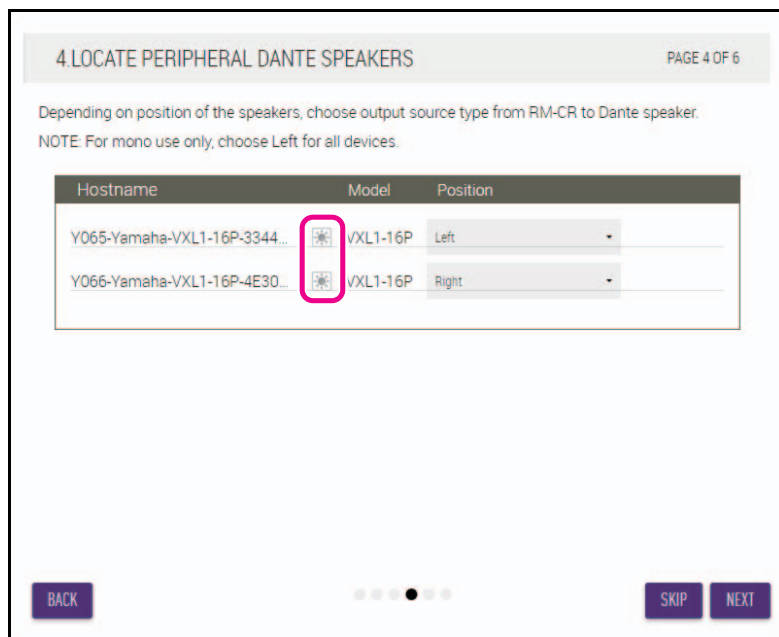

5. EXECUTE AUTOMATIC AUDIO TUNING

PAGE 5 OF 6

Adjust Volume Right (Ch.2) Speaker

Adjust the volume of your analog speakers to provide sufficient volume for the audio tuning. A test sound will be played. Increase the volume of the right channel until a sufficient volume is reached for tuning. Once a sufficient volume is reached the tuning process will automatically progress to the next page.

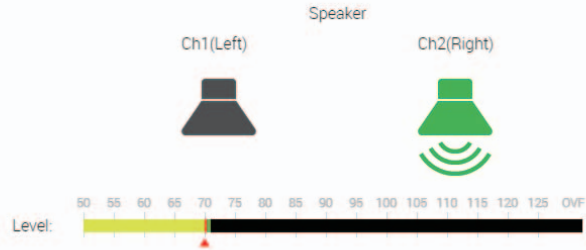

NOTE:
Skip this step if the Right Speaker channel is unused.

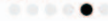

SKIP CANCEL

5. EXECUTE AUTOMATIC AUDIO TUNING

PAGE 5 OF 6

Audio tuning will start shortly. Please wait until the tuning is complete.
The approximate time will be several minutes, depending on the number of peripheral devices.

adjusting parameters



NOTE:
To measure correctly, please do not make a noise or interrupt speaker playback.



CANCEL

② Confirm that tuning has completed, and then click the [NEXT] button.

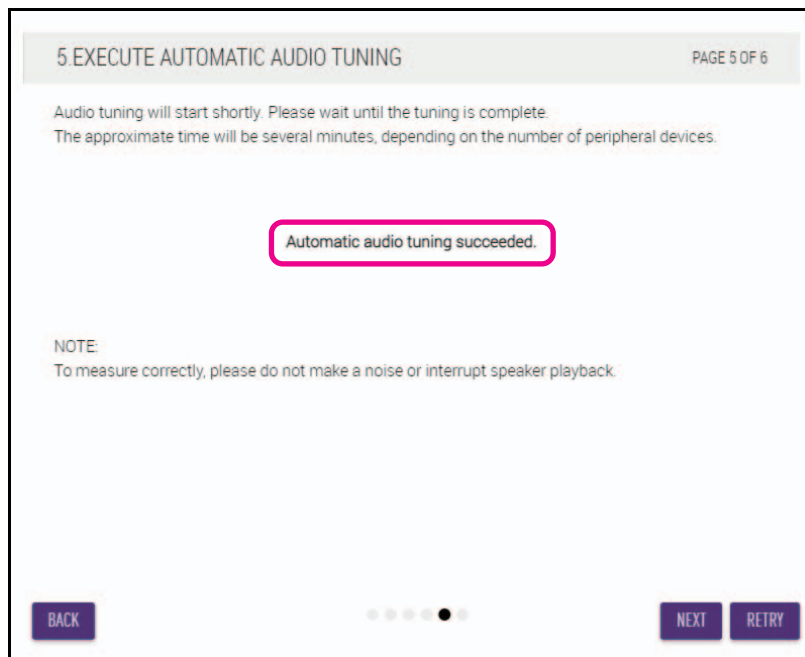

[6. READY TO USE]

Click the [CLOSE] button.

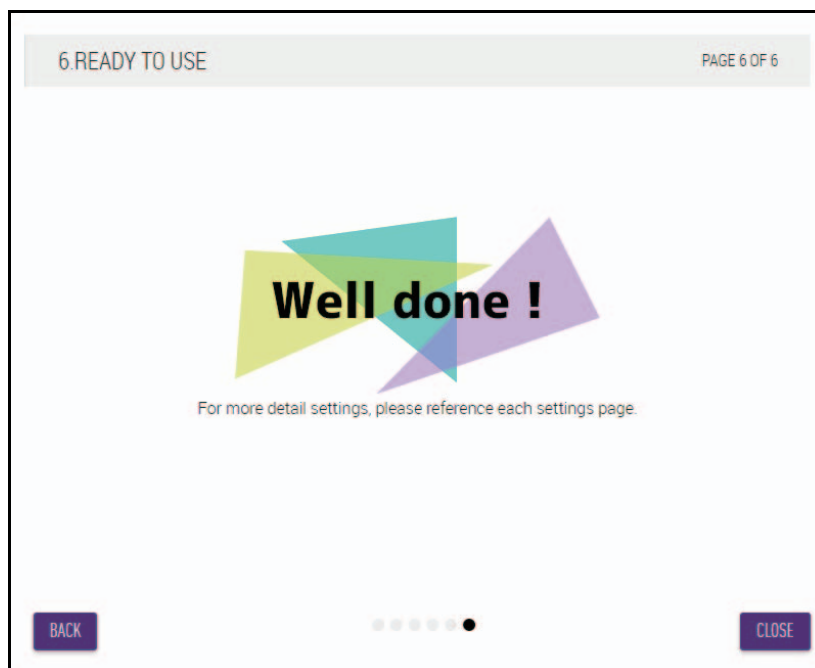

This completes the setup.

NOTE: Use the Web GUI “RM-CR Device Manager” to specify detailed settings for this unit.

CONTROLS AND FUNCTIONS

Front panel

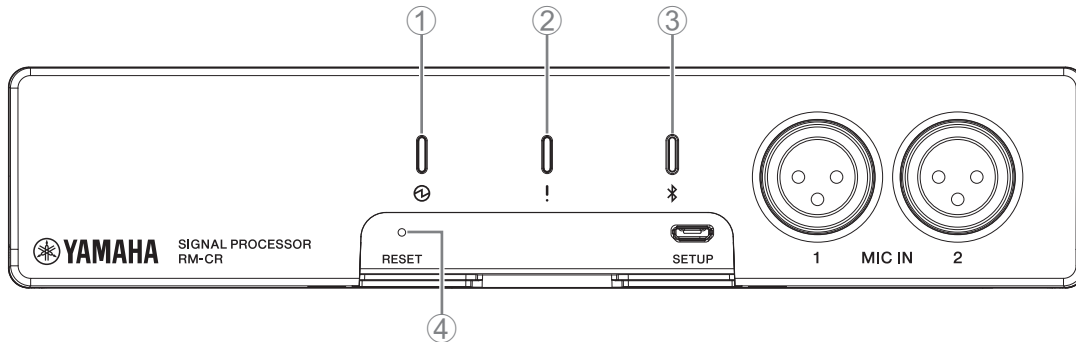

① (Power) indicator

Condition	Power indicator	Unit status
LAN cable plugged into Dante/PoE port	Lit green	Operating
LAN cable plugged into Dante/PoE port	Flashes green	Starting up
–	Flashes green quickly	Supplied power insufficient

② ! (Status) indicator

Condition	Status indicator	Unit status
Identify icon in Web GUI clicked	Flashes white	Responding (to Identify function)
Updating firmware	Flashes white quickly	Firmware being updated
Updating firmware	(After flashing white quickly) Flashes green quickly	Firmware updated successfully
–	Flashes red	Error occurring
–	Flashes red quickly	Severe error occurring

NOTE: Occurrences of errors and severe errors are recorded in the alert log. For details, refer to page 29.

③ (Bluetooth®) button/indicator

Condition	Bluetooth indicator	Unit status
Making Bluetooth connection	Brightly lit blue	Bluetooth connection being made
Bluetooth in Web GUI enabled	Dimly lit blue	Not connected (although Bluetooth can be used)
Long-pressing the Bluetooth button (with Bluetooth enabled) for 4 seconds or more	Flashes blue quickly	Waiting for pairing/Pairing
Bluetooth in Web GUI not enabled	Unlit	Bluetooth cannot be used

④ [RESET] button

Condition	Status indicator	Unit status
[RESET] button long-pressed for 4 seconds to less than 8 seconds, then released	Flashes blue twice per second (during long-pressing/resetting)	Network-related settings Waiting for resetting/Resetting
[RESET] button long-pressed for 8 seconds to less than 12 seconds, then released	Flashes blue three times per second (during long-pressing/resetting)	All settings Waiting for resetting/Resetting

NOTE: Use a fine-tipped object such as an ejector pin to press the [RESET] button.

Rear panel

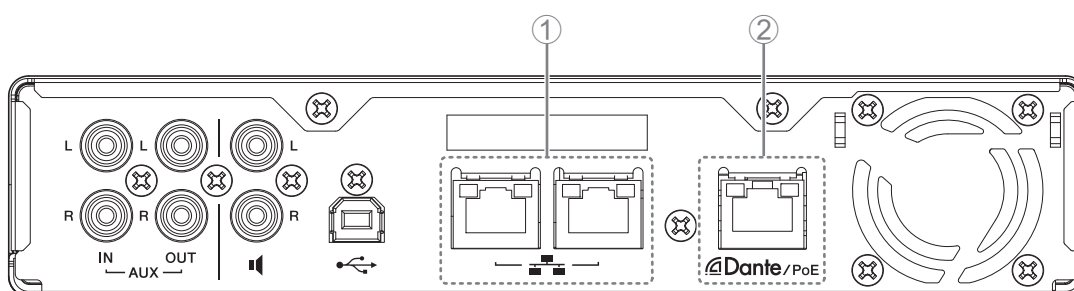

① Network port indicators (Network port)

Network port indicator	Unit status
Left indicator lit green	Link up
Left indicator flashes green	Transferring data
Left indicator unlit	Link down
Right indicator lit green	Connection speed: 1000M Link
Right indicator unlit	Connection speed: 10M Link/100M Link

② Network port indicators (Dante/PoE port)

Network port indicator	Unit status
Left indicator lit green	Link up
Left indicator flashes green	Transferring data
Left indicator unlit	Link down
Right indicator lit green	Operating on word clock of peripheral device (leader)
Right indicator flashes green	Acting as word-clock leader
Right indicator flashes orange	Word clock unlocked

CONNECTING COMMUNICATION DEVICES

The following are examples of a connection with a communication device.

Connecting a computer

Prepare the following.

- Computer
- A-B type USB cable (included with the unit)

NOTE: No installation of a USB driver is necessary.

1. Connect this unit and the computer with a USB cable.

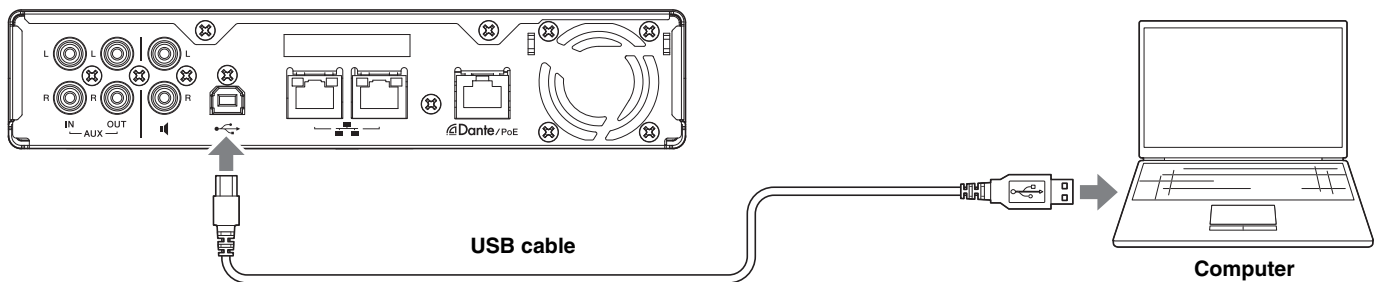

This completes the connection. Referring to the following pages, confirm that a proper connection can be made.

NOTE: The windows may differ depending on the computer.

[For Windows]

Open the Sound Control Panel, and then confirm that [Yamaha RM-CR] is set to [Default Device] on the [Playback] and [Recording] tabs. Otherwise, select [Yamaha RM-CR], click [Set Default], and then click [OK].

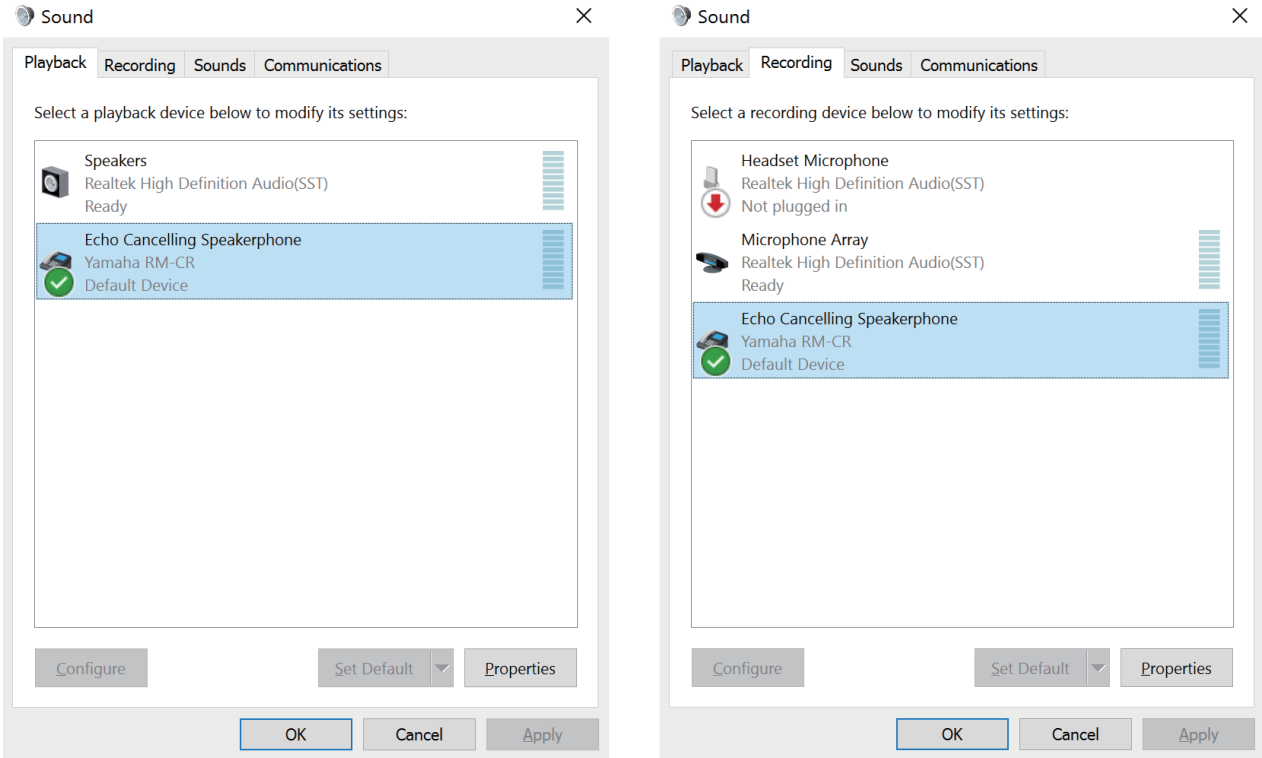

NOTE: Adjust the microphone sensitivity (input volume) as necessary. Select [Yamaha RM-CR] on the [Recording] tab, and then click [Properties] to open the [Echo Cancelling Speakerphone Properties] window. Click the [Levels] tab to display the adjuster.

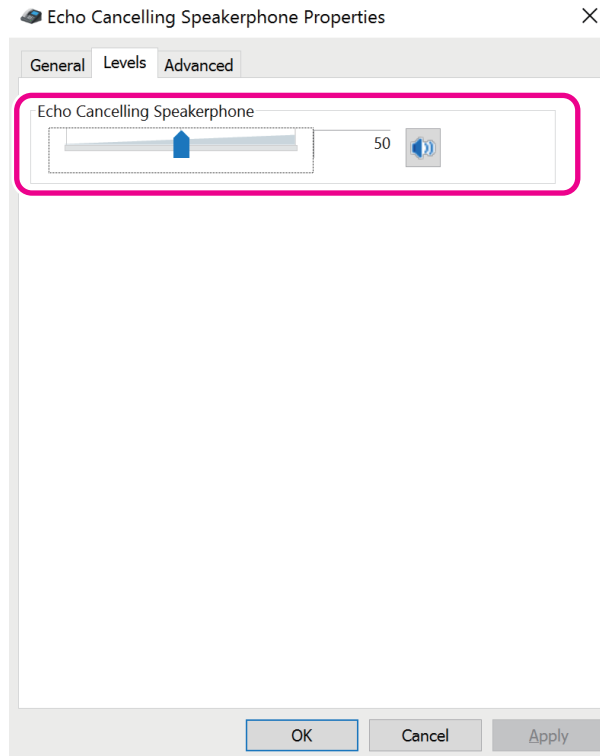

[For macOS]

Open the [Sound] preferences, and then confirm that [Yamaha RM-CR] is selected on the [Output] and [Input] tabs. Otherwise, click [Yamaha RM-CR].

NOTE: Adjust the microphone sensitivity (input volume) as necessary. The adjuster is available on the [Input] tab.

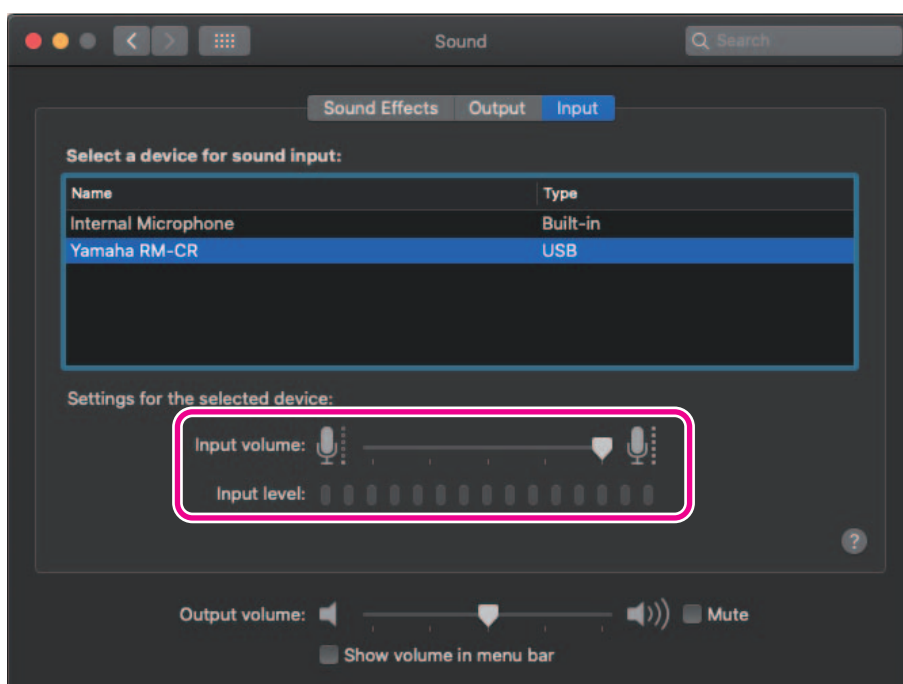
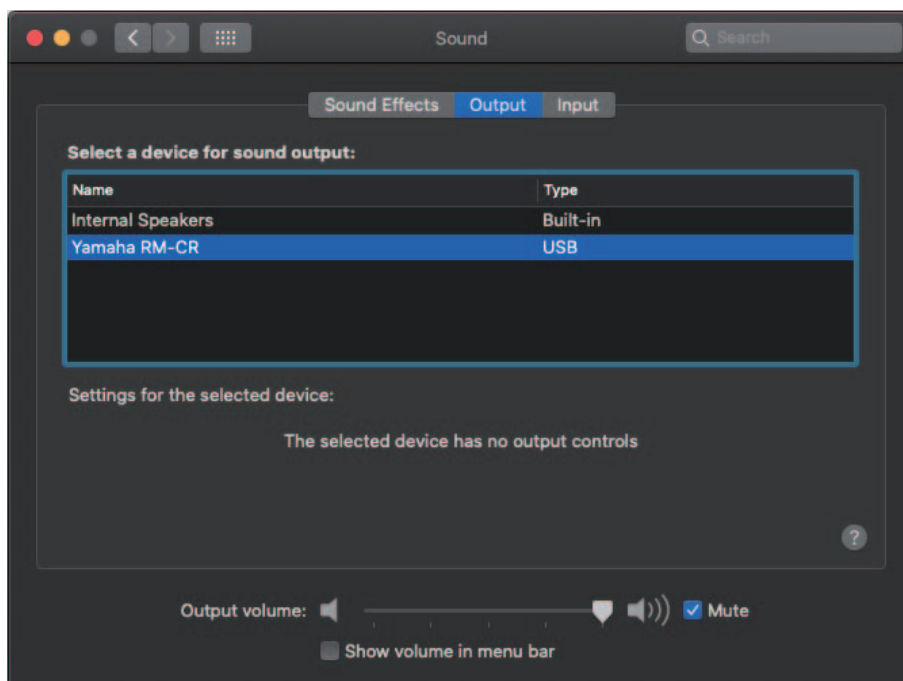

Connecting a smartphone

Prepare the following.

- Smartphone

IMPORTANT: • Bluetooth must first be enabled in the Web GUI “RM-CR Device Manager”.

- This unit cannot be connected with multiple smartphones at the same time via Bluetooth.
- This unit’s Bluetooth connection is for smartphones. Do not use it to connect a computer.

[Connecting for the first time]

1. Long-press the Bluetooth button on the front panel of the unit for four seconds or more.

The unit enters the pairing standby mode, and the Bluetooth indicator flashes blue quickly.

NOTE: Pairing means that the unit and the smartphone register each other with the information required for a Bluetooth connection.

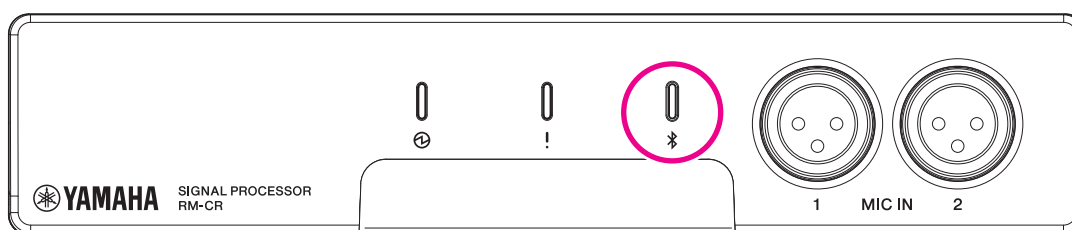

2. Enable Bluetooth on the smartphone, and select [Yamaha RM-CR-XXXXXX] (where “XXXXXX” is the MAC address of this unit).

The connection is completed as soon as pairing is finished. Check the completion of the connection from the screen of the smartphone.

IMPORTANT: As a factory default, the passkey is set to “0000” (numbers). The passkey can be changed in the Web GUI.

- NOTE:**
- If 60 seconds have elapsed without completing pairing, the pairing standby mode of this unit will be canceled.
 - To cancel the pairing standby mode, press the Bluetooth button while the Bluetooth indicator is flashing.
 - This unit can be paired with up to eight smartphones. When pairing with the ninth device has completed, the pairing with the oldest date and time of the nine smartphones will be canceled.

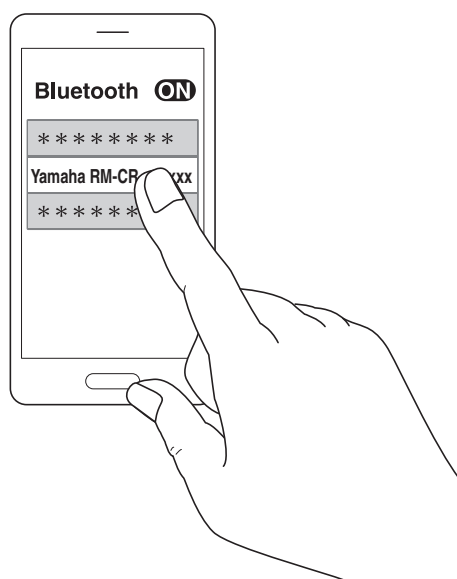

[Connecting a paired smartphone]

1. Enable Bluetooth on the smartphone, and select [Yamaha RM-CR-XXXXXX] (where “XXXXXX” is the MAC address of this unit).

This completes the connection. Check the completion of the connection from the screen of the smartphone.

[Disconnecting]

The Bluetooth connection can be cut by using any of the following methods.

- Press the Bluetooth button on the unit.
- Turn off Bluetooth from the smartphone.
- Turn off the unit or smartphone.

NOTE: Bluetooth operation of this unit can also be performed using the Web GUI “RM-CR Device Manager”.

Connecting a video conferencing system

Prepare the following.

- Video conferencing system
- Audio cable with stereo RCA jacks on one end or both ends x2

NOTE: The audio cable jacks that connect to the video conferencing system do not necessarily have to be stereo RCA jacks. Prepare cables that meet the specifications of the video conferencing system.

1. Connect this unit to the video conferencing system with the audio cables.

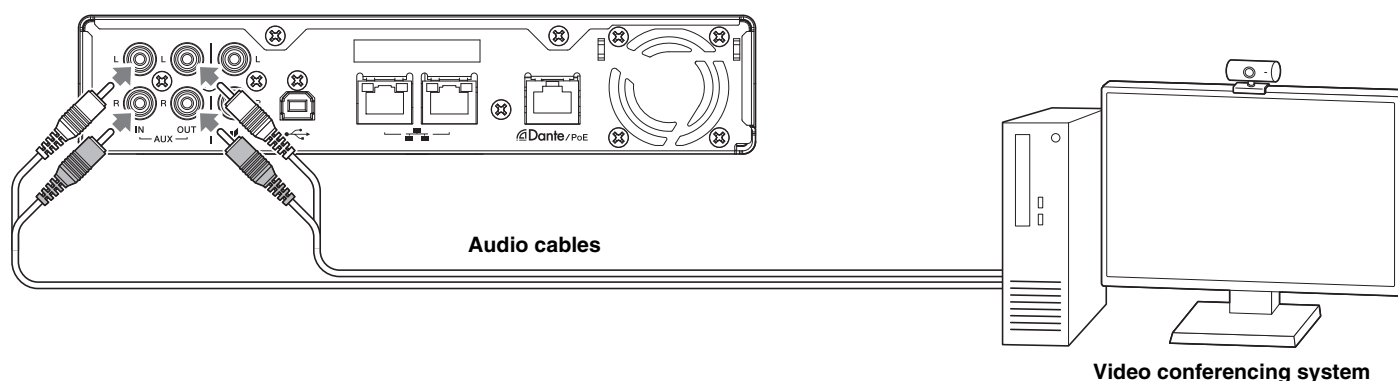

2. Check/change the audio input/output settings of the video conferencing system.

IMPORTANT: Turn off the video conferencing system microphone and speakers.

CONNECTING EXPANSION DEVICES

The following are examples of a connection to an expansion device.

Connecting a handheld microphone

Connect this unit to a handheld microphone to talk with the other party and amplify your voice at your location.

Prepare the following.

- Handheld microphone

1. Connect this unit and the handheld microphone.

NOTE: Two handheld microphones can be connected at the same time.

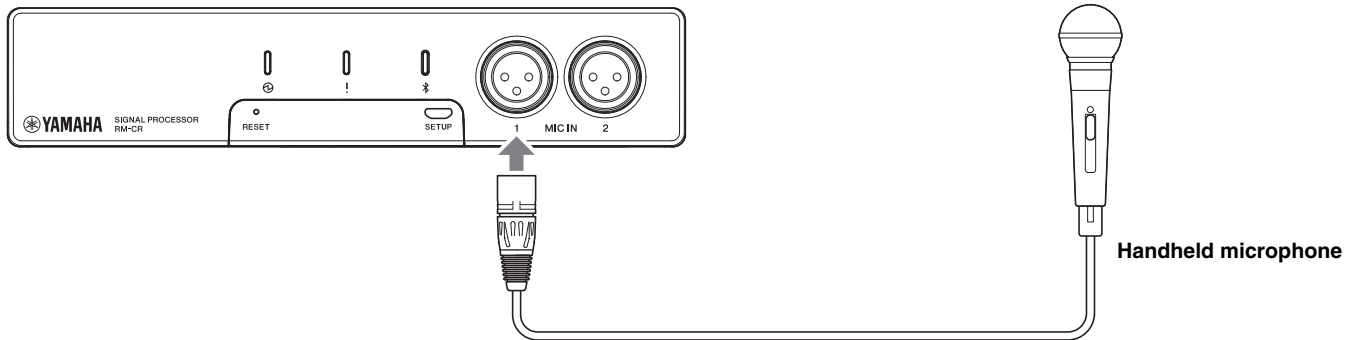

Connecting a speaker with built-in amplifier

Connect this unit to a speaker with built-in amplifier to expand the playback range at your location.

Prepare the following.

- Speaker with built-in amplifier
- Audio cable with RCA jack on one end or both ends

NOTICE: Use a speaker with built-in amplifier that has little delay and distortion. Using a speaker with a lot of delay or distortion may cause echoing for the other party.

NOTE: The audio cable jack that connects to the speaker with built-in amplifier does not necessarily have to be an RCA jack. Prepare a cable that meets the specifications of the speaker with built-in amplifier.

1. Connect this unit and the speaker.

NOTE: Two speakers with built-in amplifiers can be connected at the same time.

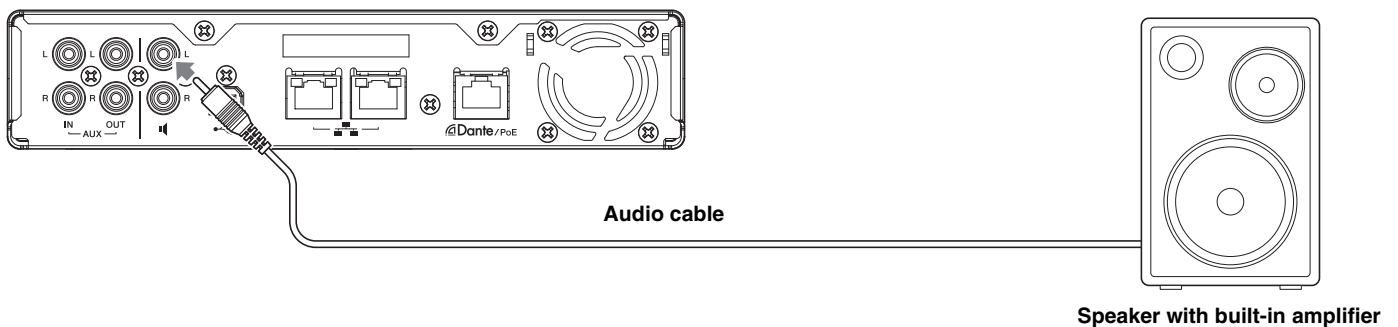

AVAILABLE UTILITY SOFTWARE

Starting up the Web GUI Device Manager

The Web GUI “RM-CR Device Manager” is an application for administrators to check/change the settings of this unit and ADECIA. Follow the steps below to start it up.

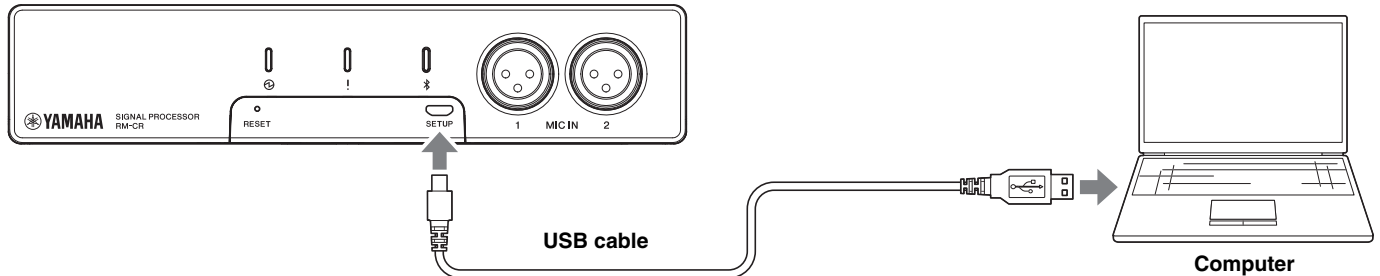

- 1. Connect this unit and the computer with an A-micro B type USB cable.**
- 2. Start a browser (Google Chrome or Safari) on the computer and type “172.16.0.1” in the address bar.**
The RM-CR Device Manager starts up.
- 3. Type the specified password into the login window, and then click the [LOGIN] button.**

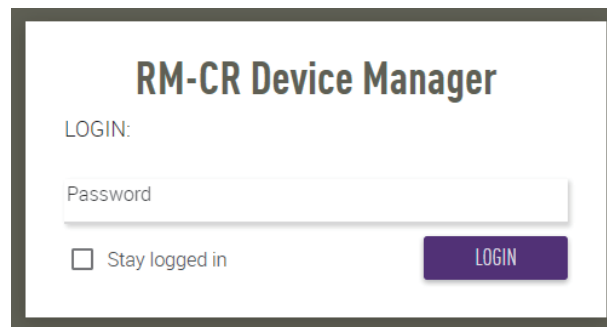

The [HOME] window appears.

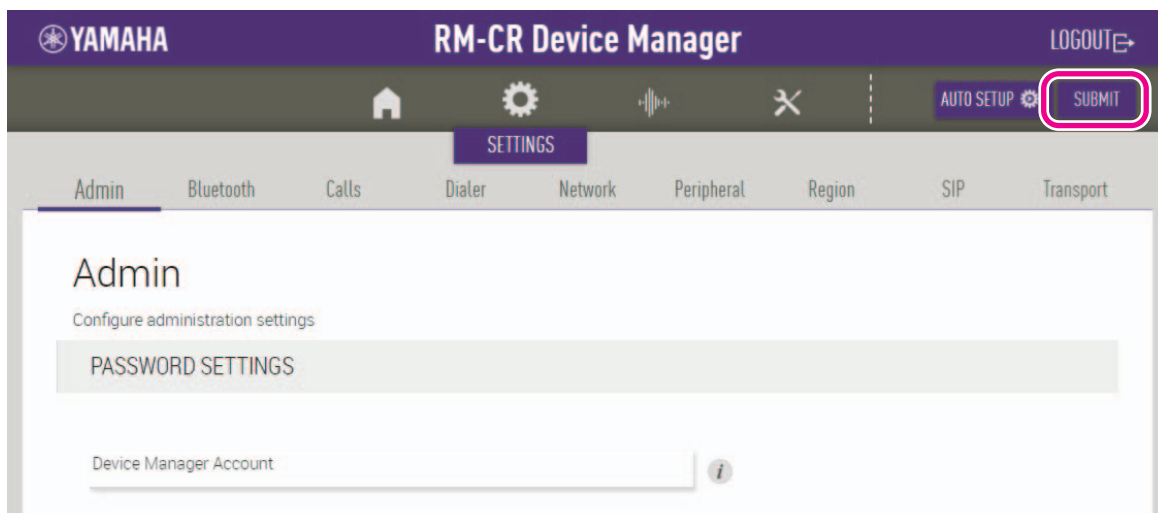

- NOTE:**
- For details on using the Web GUI “RM-CR Device Manager”, refer to the separate RM-CR RM-CG RM-TT Web GUI Device Manager Operation Guide.
 - The RM-CR and computer can also be connected using an Ethernet cable via a network switch. In that case, in order to start the Web GUI “RM-CR Device Manager”, the application “RM Device Finder” is necessary to detect RM series devices on the network. For details, refer to the User Guide included with RM Device Finder.

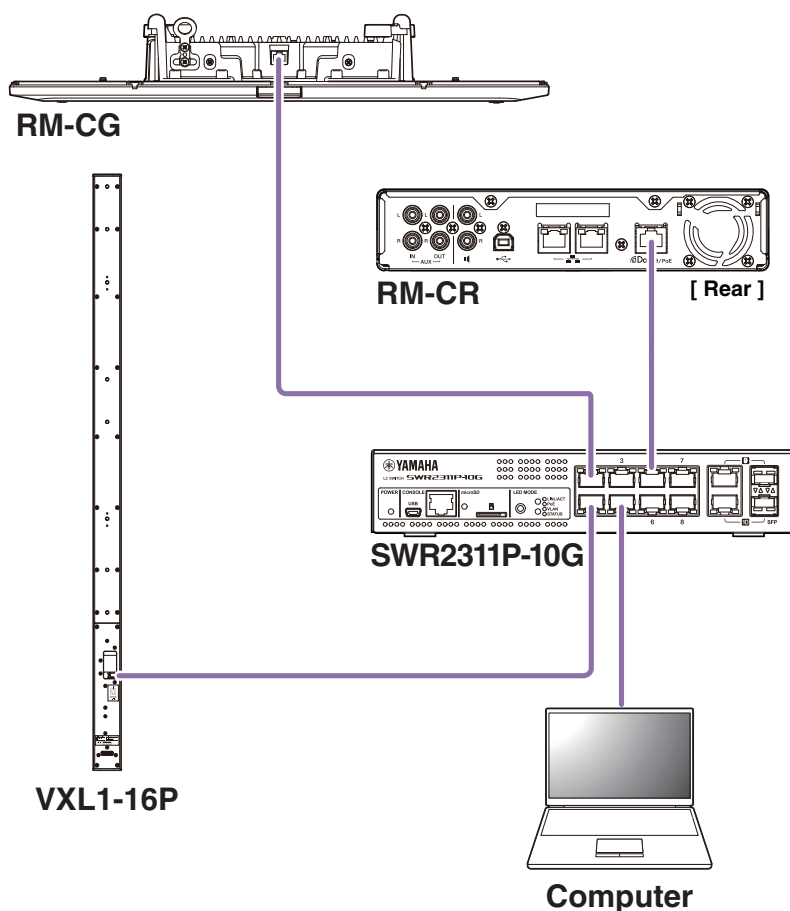

The latest software and manuals can be downloaded from the following website.

▼ **Yamaha website (Downloads)**

U.S.A. and Canada:

<https://uc.yamaha.com/support/>

Other Countries:

<https://download.yamaha.com/>

Using ProVisionaire Control

ProVisionaire Control is Windows application software that allows you to remotely control parameters for various devices from a single control panel. With the RM series, ProVisionaire Control is installed in the conference room and used to control the conference audio routes and calls. This is necessary especially for VoIP calls and conference rooms where multiple call routes (VoIP/Bluetooth/AUX/USB) are used simultaneously. Template files for controlling the route of conference calls using the RM series can be downloaded from the RM-CR website.

The following is an example of a connection using ProVisionaire Control.

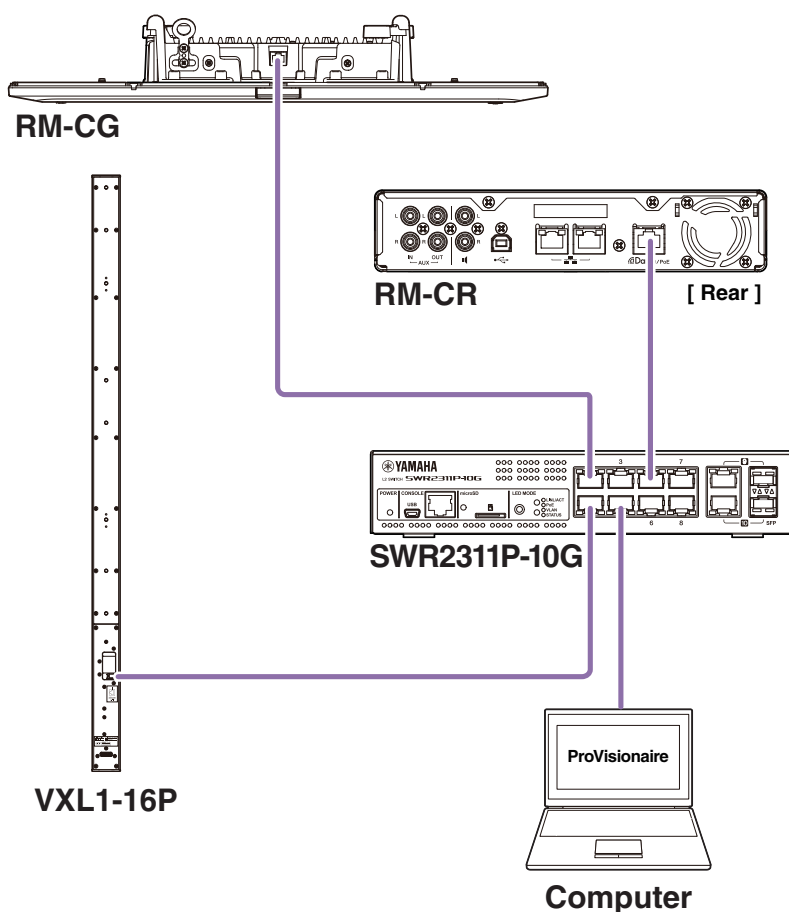

NOTE: For details on using ProVisionaire Control, refer to the ProVisionaire Control Setup Guide.

The manual can be downloaded from the following website.

▼ **Yamaha website (Downloads)**

U.S.A. and Canada:

<https://uc.yamaha.com/support/>

Other Countries:

<https://download.yamaha.com/>

APPENDIX

Block diagram

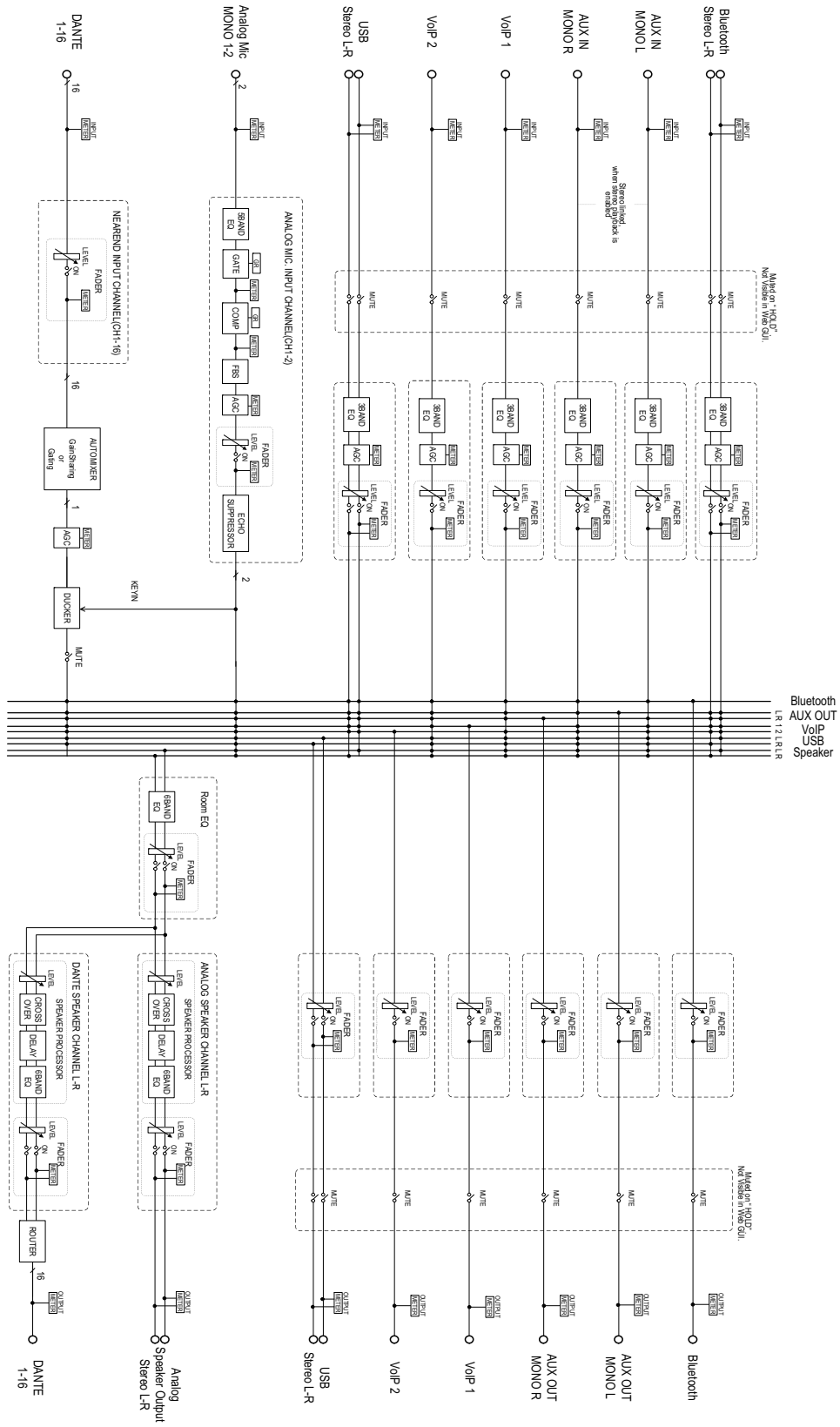

Alert log list

This provides details on the main alert log messages contained in the log files. The log file can be downloaded via [TOOLS]→[Logs].

Display	Description	What to do
[0x010B0020] important mic CH* broken	Important mic CH* broken.	Please contact your Yamaha dealer.
[0x00080000] Bluetooth hardware error	Bluetooth has not worked correctly.	Turn the power off, then turn the power on after waiting at least six seconds. If this does not solve the problem, please contact your Yamaha dealer.
[0x000a0000] Dante hardware error	Dante has not started up correctly.	Turn the power off, then turn the power on after waiting at least six seconds. If this does not solve the problem, please initialize the memory. Should this also fail, contact your Yamaha dealer.
[0x01070003] Firmware update failed, because of *	Failure of firmware update has occurred.	Check firmware file on the firmware update pages of Web GUI.
[0x01070004] Firmware update failed, because of internal error		Turn the power off, then turn the power on after waiting at least six seconds. If this does not solve the problem, please contact your Yamaha dealer.
[0x01040001] SIP internal error	Internal error has occurred in SIP.	Turn the power off, then turn on after waiting at least six seconds. If this does not solve the problem, please initialize the memory. Should this also fail, contact your Yamaha dealer.
	Internal error has been occurred with SIP.	
[0x00090000] USB audio hardware error	A problem has occurred with USB audio.	Turn the power off, then turn the power on after waiting at least six seconds. If this does not solve the problem, please initialize the memory. Should this also fail, contact your Yamaha dealer.
[0x01050009] Web UI internal failure	Internal failure has occurred in Web GUI.	Turn the power off, then turn the power on after waiting at least six seconds. If this does not solve the problem, please initialize settings. Should this also fail, contact your Yamaha dealer.
[0x01010007] failed to start audio proc	The device audio has not started up correctly.	Turn the power off, then turn on after waiting at least six seconds. If this does not solve the problem, please initialize the memory. Should this also fail, contact your Yamaha dealer.
[0x00010000] System error	The device has not started up correctly.	
[0x00010001] Power unstable	The device is not supplying power normally.	Connect to a PoE+ compatible switch. If this does not solve the problem, please turn the power off, then turn on after waiting at least six seconds. Should this also fail, contact your Yamaha dealer.
[0x01060001] Syslog setting error	Failed to update syslog transfer servers.	Turn the power off, then turn the power on after waiting at least six seconds. If this does not solve the problem, please initialize settings.
[0x01060003] logging error	Failed to restart logging.	
[0x010B0044] Automatic audio tuning failed, because of internal error.	Automatic audio tuning has failed, because internal error has occurred.	Turn the power off, then turn the power on after waiting at least six seconds. Please try again. If this does not solve the problem, contact your Yamaha dealer.

Display	Description	What to do
[0x010B0045] Automatic audio tuning failed, because of speaker output too low.	Automatic audio tuning has failed, because speaker output is too low.	Check connection and settings of speakers.
[0x010B0046] Automatic audio tuning failed, because of speaker output undetected.	Automatic audio tuning has failed, because the system could not detect audio output from speaker.	
[0x010B0047] Automatic audio tuning failed, because of measurement environment too noisy.	Automatic audio tuning has failed, because measurement environment is too noisy.	Do not make any noise during execution.
[0x010B0048] Automatic audio tuning failed, because of audio input from peripheral Dante mic undetected.	Automatic audio tuning has failed, because the system could not detect audio input from Dante microphone.	Check audio input on Audio Input page.
[0x010B0049] Automatic audio tuning failed, because of no peripheral Dante mic registered.	Automatic audio tuning has failed, because peripheral Dante microphone is not registered.	Register at least one peripheral Dante microphone.
[0x010B0050] Automatic audio tuning failed, because of peripheral network disconnection.	Automatic audio tuning failed, because of peripheral network disconnection.	Check network settings and connection.
[0x000a0001] Dante started in fail safe mode	Dante has started in failsafe mode.	Execute Failsafe Recovery using Audinate's firmware update tool.
[0x000a0002] Unable to configure Dante, because the Dante device is locked.	Dante is currently limited to control settings, because the device is locked.	Unlock device lock using Dante Controller or check Dante Domain Manager settings.
[0x010C0001] Resume data lost	The settings saved in internal memory has been lost.	Initialize the memory. If this dose not solve the problem, contact your Yamaha dealer.
[0x010C0002] Saving setting data failed	The device has not started up correctly.	Turn the power off, then turn the power on after waiting at least six seconds. If this does not solve the problem, please initialize the memory. Contact your Yamaha dealer if problem still exists.
[0x010D0001] CPU temperature too high	CPU temperature has been too high.	Turn the power off, let the CPU cool down. Turn the power on again. If the temperature is still too high, check the installation environment and whether dirt or a foreign object could have clogged the cooling fan, and clean the fan if necessary.
[0x010D0002] Fan hardware error	Hardware error has occurred in fan speed.	Check whether dirt or a foreign object could have clogged the cooling fan, and clean the fan if necessary. If this does not solve the problem, please turn the power off, then turn the power on after waiting at least six seconds. Should this also fails, contact your Yamaha dealer.
[0x00070003] Too many devices on the network	Too many devices are connected to the network.	Reduce the number of devices connected to the network.

Display	Description	What to do
[0x01100010] Configuration import failed, because of file download failure (*)	Configuration import has failed, because of file download failure.	Check network, server address settings, existence of configuration file at server.
[0x01100011] Configuration import failed, because of file format error (*)	Configuration import has failed, because of file format error.	Check contents and format of configuration file.
[0x01100012] Configuration import transfer failed, because of wrong filename or peripheral disconnected (*)	Configuration import transfer has failed, because of wrong filename or peripheral disconnected.	Check file name and connection status of peripheral device.
[0x01100013] Configuration import failed, because the system is busy (*)	Configuration import has failed, because of system busy.	Check device status and try again. If it is still not working, please update firmware or reset all of the settings.
[0x01100014] Configuration import failed, because of internal error (*)	Configuration import has failed, because of internal error.	Try again. If its not working again, please update firmware or reset all of settings.
[0x01090001] Schedule data lost	The schedule data saved in internal memory has been lost.	If this occurs often, contact your Yamaha dealer.
[0x01080001] Peripheral communication error	A peripheral device within the system was not found on the network.	Power-on all peripheral devices in the system, and make sure that they are correctly connected to the network.
[0x01040002] SIP unavailable, because of server registration error	SIP is currently unavailable, because of server registration failure.	Check SIP and network settings.
[0x01040003] SIP server registration failed (code: *)	SIP server registration failure has occurred.	Check error code and settings.
[0x01040001] SIP internal error	SIP internal error occurred.	Please check that there are no problems with the RM-CR's SIP configurations.
[0x01010005] Factory reset failed	Factory reset has failed.	-
[0x01010006] * reset failed	Partial reset has failed.	
[0x01050002] Web UI login failure by *	Web GUI login failure has occurred by (IP address).	Check password.
[0x01090004] Scheduling event failed, because of *	Scheduling event has failed.	Check the number of scheduled events.
[0x00080001] Bluetooth hardware restarted	Bluetooth had not worked correctly and was restarted.	If this occurs often, contact your Yamaha dealer.
[0x010B0040] Audio processing restarted	Audio processing failure has occurred, then restarted.	
[0x01010013] SNMP error	SNMP operation has failed to start.	Turn the device off, then on again after waiting at least six seconds. If this does not solve the problem, initialize the memory. Contact your Yamaha dealer if the problem persists.
[0x010f0004] IEEE802.1X restart failed	Failed to start the IEEE802.1X operation.	Turn the unit off, then on again after waiting at least six seconds. Contact your Yamaha dealer if the problem persists.

Display	Description	What to do
[0x010B0100] High noise level detected on DANTE audio input CH* (*dB SPL).	A high noise level (*dB SPL) was detected on Dante audio input CH*.	Check the operating environment, and then try again. Avoid making noise during the process.
[0x010B0101] Long reverberation time detected on DANTE audio input CH* (*msec).	A long reverberation time (*msec) was detected on Dante audio input CH*.	Check the operating environment, and then try again.
[0x010B0102] Analog speaker CH* measurement failed (input CH*, signal level *dB SPL, noise level *dB SPL, gain *dB).	Measurement of analog speaker CH* failed (input CH*, signal level *dB SPL, noise level *dB SPL, gain *dB).	Check the speaker connections and settings, and then try again.
[0x010B0103] Dante speaker CH* measurement failed (input CH*, signal level *dB SPL, noise level *dB SPL, gain *dB).	Failed to measure Dante speaker CH* (input CH*, signal level *dB SPL, noise level *dB SPL, gain *dB).	Check the speaker connections and settings, and then try again.

EXPLANATIONS

About configuration files and presets

About configuration files

- The configuration information of RM series devices can be exported to a file. This exported file is called a configuration file.
- Configuration files have the .xml extension.
- Separate configuration files for RM-CR, RM-CG, RM-TT, and RM-WAP (including the wireless microphone and charger) can be exported. Configuration files can be exported via [TOOLS]→[Configuration]→[EXPORT CONFIGURATION] in the corresponding device's Web GUI Device Manager.
- In addition, the Web GUI "RM-CR Device Manager" can export configuration files for RM-CG, RM-TT, RM-WAP and VXL-1-16P registered in the same ADECIA system. These configuration files can be exported via [SETTINGS]→[Peripheral]→[REGISTRATION SETTINGS]→[VIEW] beside the corresponding device→[Peripheral Detail]→[EXPORT CONFIGURATION] in the Web GUI "RM-CR Device Manager".
- The MAC address of the device is used as the file name of the exported configuration file. For RM-CR, the MAC address for the corporate port is used.
- Configuration files do not include the following information:
 - Passwords
 - RM-CR Bluetooth pairing information
 - Pairing information for the RM-WAP microphone and charger (After pairing, the information and status of the devices connected to the RM-WAP are included in the configuration file.)

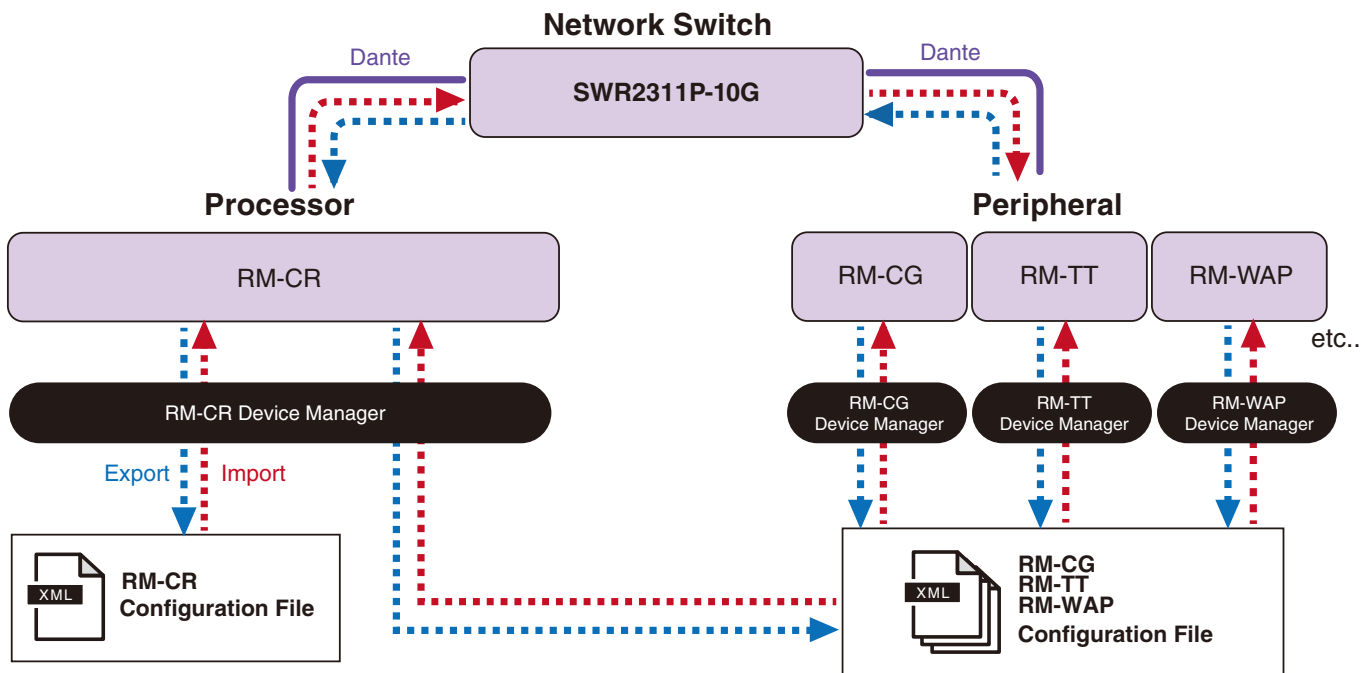

- The exported configuration file can be used for importing.
- Configuration files can be imported via [TOOLS]→[Configuration]→[IMPORT CONFIGURATION] in the corresponding device's Web GUI Device Manager.
- In addition, the Web GUI "RM-CR Device Manager" can import configuration files for RM-CG, RM-TT, RM-WAP and VXL-1-16P registered in the same ADECIA system. These configuration files can be imported via [SETTINGS]→[Peripheral]→[REGISTRATION SETTINGS]→[VIEW] beside the corresponding device→[Peripheral Detail]→[IMPORT CONFIGURATION] in the Web GUI "RM-CR Device Manager".

- When importing a configuration file, its name (MAC address) must match the MAC address of the device into which the file will be imported. When replacing a device due to device failure, for example, change the file name of the exported configuration file to the MAC address of the newly installed device before importing the file.
- For information on exporting and importing configuration files, refer to the RM-CR RM-CG RM-TT Web GUI Device Manager Operation Guide or the RM Series Wireless Microphone System Web GUI Device Manager Operation Guide.

About presets

- A combination of configuration files for RM-CR, RM-CG, RM-TT, RM-WAP and VXL-1-16P can be saved and recalled as a preset. There are two ways to import the configuration files: one for each device or multiple files compressed into one (ZIP format). If configuration files with the same file name are imported, the files will be overwritten with priority given to the last one.
- Presets make it easier to configure and manage multiple devices in an ADECIA system.
- Up to 10 presets can be saved.
- Presets can be saved and recalled via [TOOLS]→[Preset]→[CONFIGURED PRESETS] in the Web GUI “RM-CR Device Manager”. From this window, you can also recall the settings from a configuration file saved on the deployment server.
- When using presets, it is recommended to select [SETTINGS]→[Peripheral]→[DEVICE SETTINGS]→[Enable automatic Dante audio routing] in the RM-CR Device Manager. This enables automatic routing of Dante patches. If this is not selected, Dante audio patches must be managed manually using a Dante Controller or similar device.
- For information on saving and recalling presets, refer to the RM-CR RM-CG RM-TT Web GUI Device Manager Operation Guide.
- Presets can also be used with the Divide/Combine Room systems described below. In a Divide/Combine Room system where RM Device Finder is used, presets can be saved for multiple RM-CRs on the network, and the switching between those presets can be reviewed at the same time. For details, refer to the RM Device Finder User Guide.

Remote control of preset recalls

■ ProVisionaire Control

ProVisionaire Control is Windows application software that allows you to remotely control parameters for various devices from a single control panel. ProVisionaire Control can also be used to switch between presets. Template files for switching between presets can be downloaded from the ADECIA product website.

■ Remote control protocol

Presets can also be switched from an external device that implements a remote control protocol. For details on the protocol, refer to the RM Series Remote Control Protocol Specifications.

About Divide/Combine Room

- Presets can be used to switch settings when sharing audio signals among multiple rooms or when one room is divided into variable partitions, etc. The audio signal input/output settings can be changed depending on how rooms are divided or combined. Although the Web GUI “RM-CR Device Manager” can be used with Divide/Combine Room systems, RM Device Finder makes it easier to configure room and device settings. For information on configuring a Divide/Combine Room system, refer to the RM Device Finder User Guide.

System image when using two conference systems individually (Divide Room)

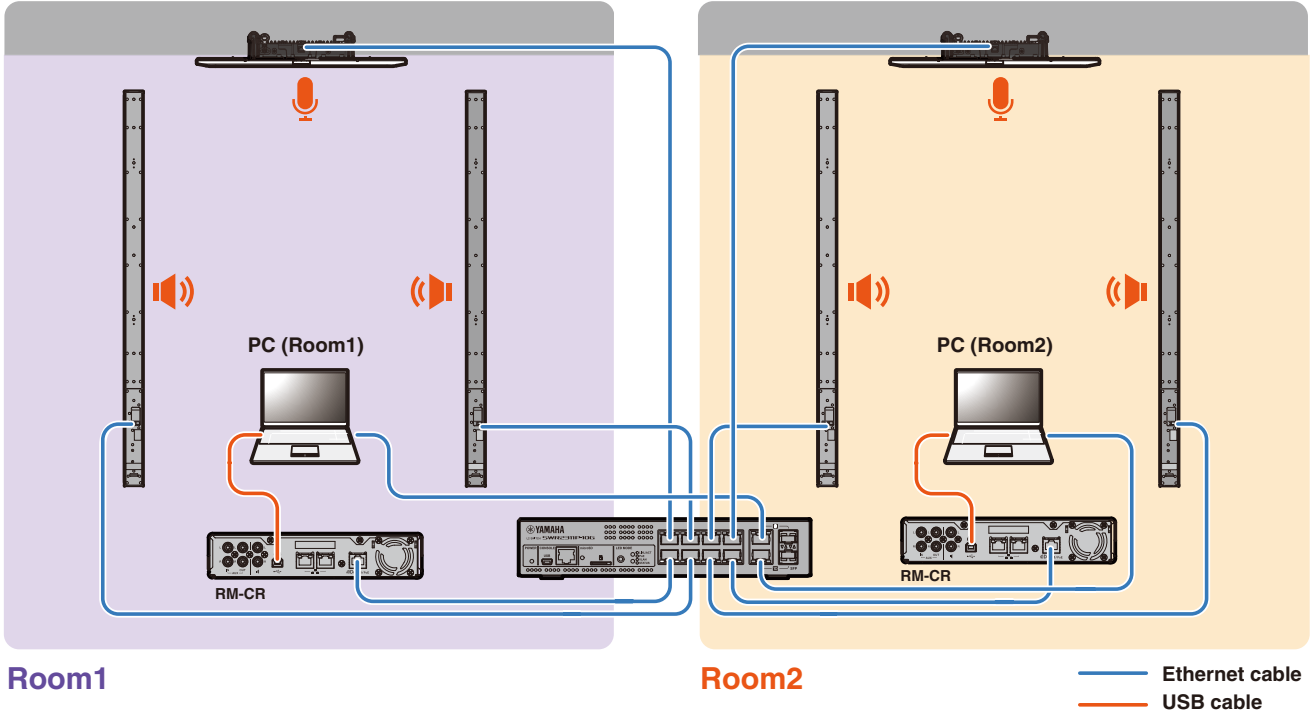

System image when using two conference systems combined (Combine Room)

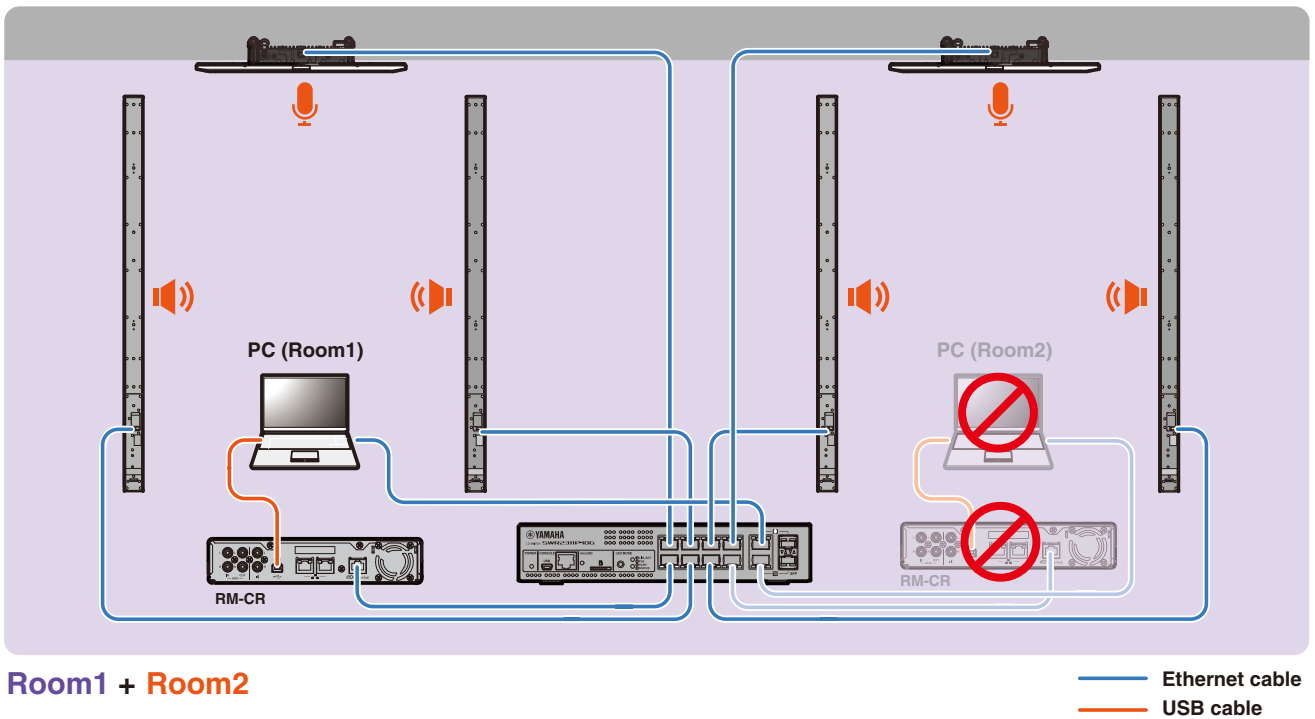

About deployment servers

- A deployment server refers to a tool or server that collectively configures and distributes device configuration files to devices in the same network.
- A deployment server may be a dedicated server on a company's or building's local network in order to manage the configuration of complex equipment.
- An RM series device can centrally manage the settings of all devices via a deployment server. In addition, when the DHCP server option is used, the deployment server's configuration file can be applied to the device simply by connecting the device to the network.

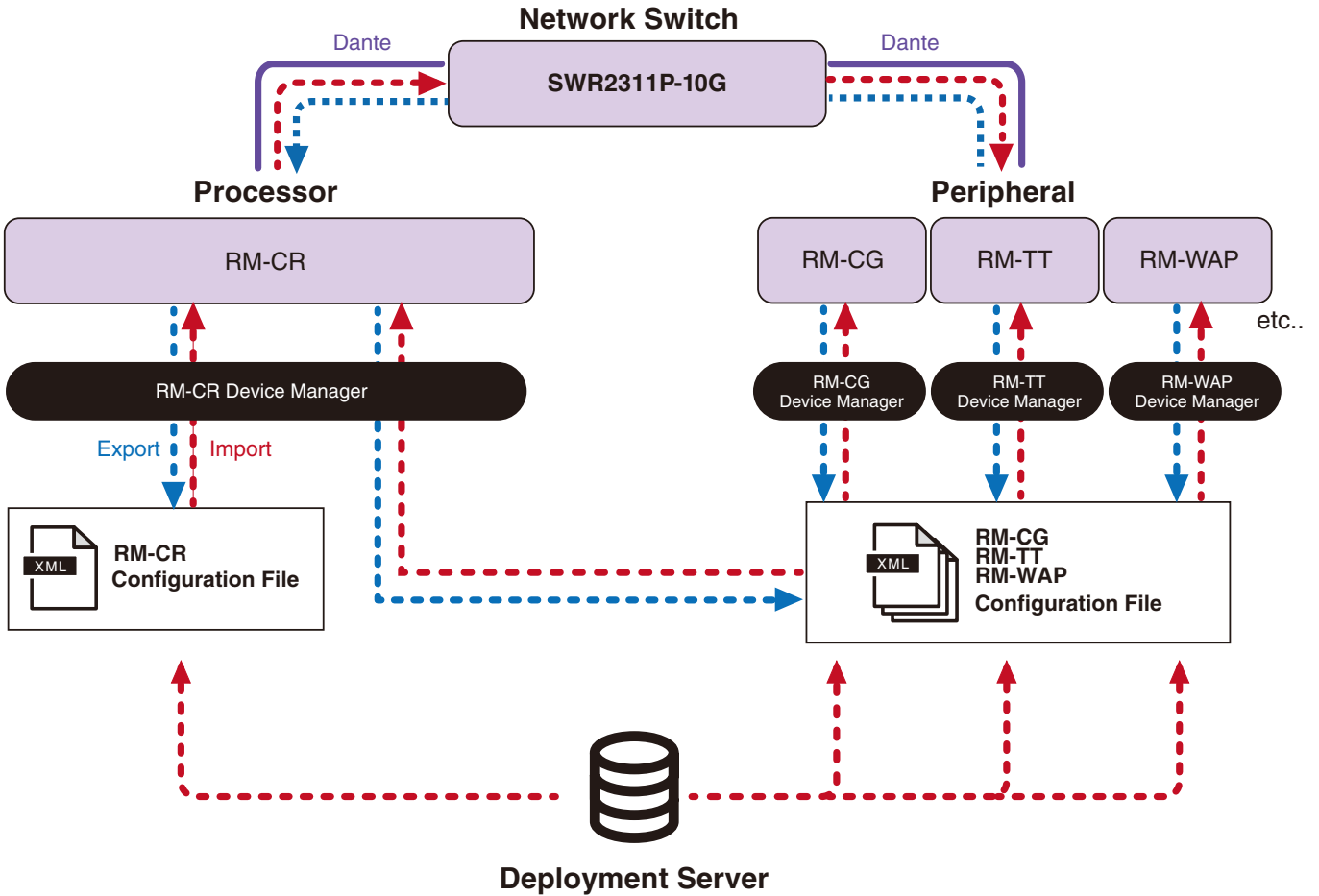

- ADECIA settings when centrally managing ADECIA devices with a deployment server
 - Specify the necessary information in [SETTINGS]→[Admin]→[DEPLOYMENT SERVER SETTINGS] of the appropriate Web GUI Device Manager for RM-CR, RM-CG, RM-TT or RM-WAP.

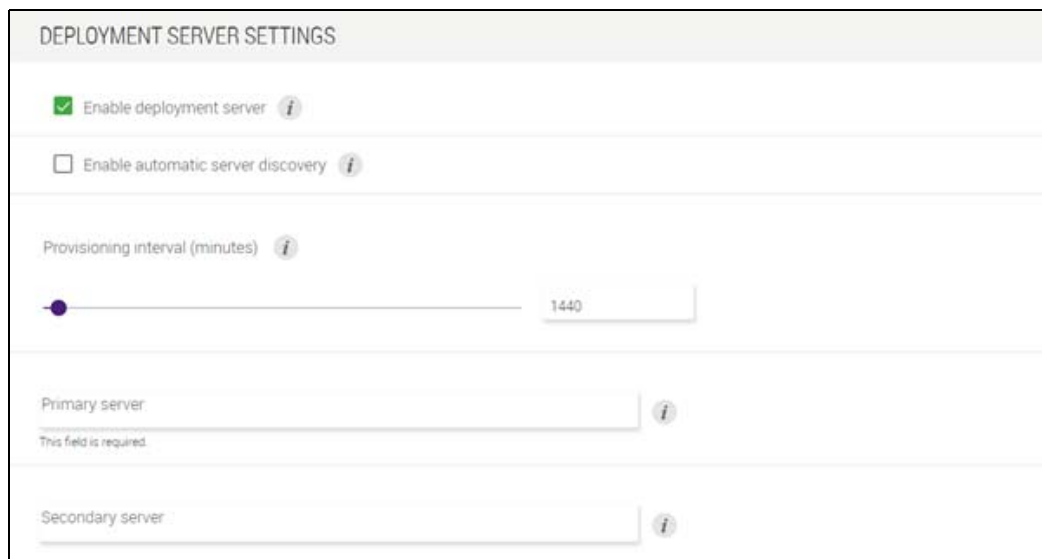

- To use a deployment server, select [Enable deployment server].
- In an environment where a DHCP server is used, if [Enable automatic server discovery] is selected when “TFTP Server Name” is enabled for “DHCP Option 66” or “DHCP Option 150”, the deployment server will be automatically detected, and the deployment server’s configuration file will be applied to the device simply by connecting the device to the network. In that case, there is no need to specify the primary server or secondary server, described below.
- Specify the time interval for ADECIA devices to query the deployment server.
- Specify the IP address of the deployment server and the path to the configuration file. Two servers can be specified: a primary server and a secondary server.
- There are two options for managing devices by using deployment servers and configuration files.
 - 1) By separately specifying the path to each deployment server for RM-CR, RM-CG, RM-TT and RM-WAP
 - 2) By specifying only on the RM-CR deployment server the path to where all ADECIA device configuration files are consolidated
 - With option 2), do not configure the RM-CG, RM-TT or RM-WAP deployment servers. Otherwise, the importing process will be duplicated.
 - With option 2), VXL-1-16P configuration files can also be handled at the same time.

About microphone grouping

By dividing the microphones into groups, muting for each group can be controlled separately. By default, the muting of all microphones is linked.

Group numbers are assigned via the following:

- **RM-CG, RM-TT**

[SETTINGS]→[Peripheral]→[MICROPHONE GROUP MUTE SETTINGS]→[Group] in the Web GUI “RM-CR Device Manager”

- **RM-W series**

[SETTINGS]→[Peripheral]→[MICROPHONE GROUP MUTE SETTINGS]→[VIEW] under “Group”→[Peripheral Detail]→[MICROPHONE SETTINGS]→[Mute Group] in the Web GUI “RM-CR Device Manager”

Alternatively: [SETTINGS]→[MICROPHONE]→[Group] in the Web GUI “RM-WAP Device Manager”

In order to control the muting for each group, the following setting must be selected in the Web GUI “RM-CR Device Manager”.

[SETTINGS]→[Peripheral]→[DEVICE SETTINGS]→[Enable microphone group mute control]

About network security and easy RADIUS security configuration

The ADECIA solution supports a security authentication system based on IEEE802.1X authentication. By using this feature, the leaking of meeting information and unauthorized access can be prevented in the event that a malicious unregistered terminal connects to the network. Information that an unregistered terminal has connected to the network is output to the log file.

What is IEEE802.1X?

IEEE802.1X is a standard for user authentication and port authentication in wired and wireless LANs, allowing you to build a secure network system without affecting traffic.

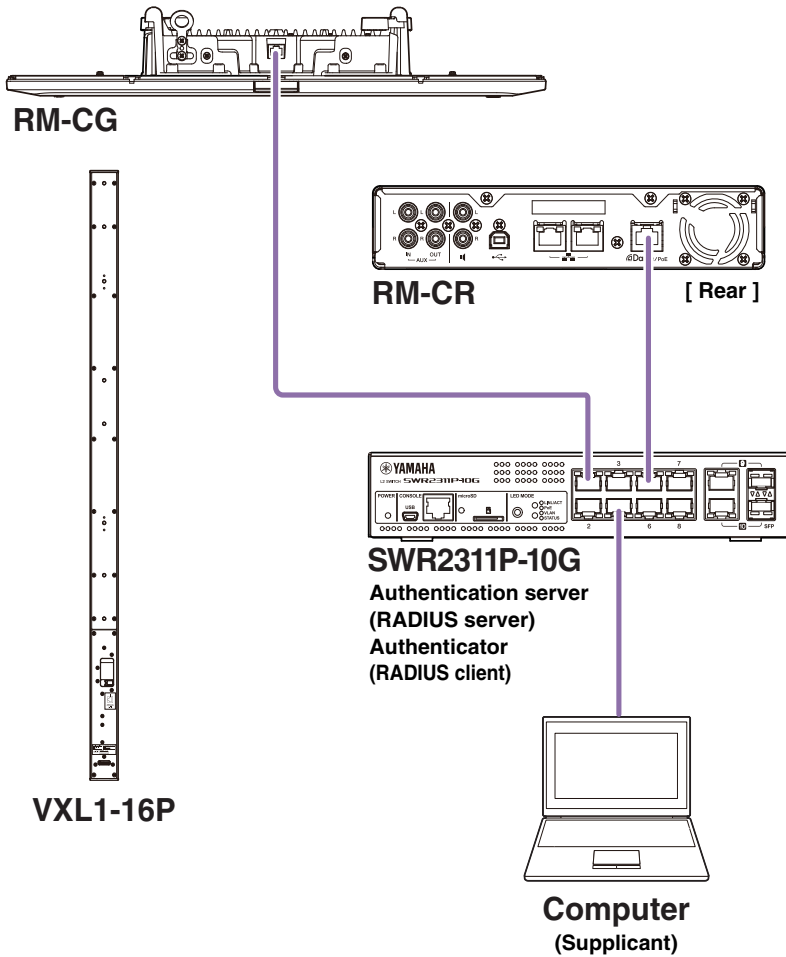

Three components are required to perform IEEE802.1X authentication: a supplicant, an authenticator and an authentication server.

■ Supplicant

This refers to the client in IEEE802.1X authentication or the software installed on the client. This is a standard feature supported by most computers.

■ Authenticator

This is a network device that acts as an intermediary between the supplicant and the authentication server. In an ADECIA solution, SWR2311P-10G acts as an authenticator.

■ Authentication server

This is a server that performs authentication. The RADIUS server* is a typical authentication server. SWR2311P-10G in an ADECIA solution also has authentication server functionality.

* RADIUS server: A server that provides functionality based on a communication protocol called "Remote Authentication Dial-In User Service"

About easy RADIUS security configuration

By using a network switch that supports the easy RADIUS security configuration feature for ADECIA, from the device port side of the network, you can easily restrict and manage the terminals that can connect. SWR2311P-10G is compatible with this feature.

Specify settings via [TOOLS]→[Plugin]→[Yamaha Quick & Easy Radius Security] in the Web GUI “RM-CR Device Manager”.

Since this setting is shared by the multiple network switches on the same network, RADIUS security can be managed without awareness of the devices.

Note:

- This feature is intended to be used when introducing a new ADECIA system.
- The switch firmware must be updated and initialized. Especially when incorporating a switch from another system into the ADECIA system, update and initialize the firmware. Before using this feature with a switch that has already configured its own network security, consult with your network administrator about whether this feature should be used and whether it should be initialized.
- Do not directly change switch settings while security operations are being performed using easy RADIUS security configuration.
- When using the Divide/Combine Room function, set this feature in the Combine Room mode.
- If multiple RM-CRs (up to 4) exist on the network, this feature can be configured from any RM-CR; however, do not specify this feature on multiple RM-CRs. Otherwise, the settings specified on other RM-CRs may be overwritten.

About RADIUS servers

For details on RADIUS servers, refer to the following Yamaha website. (Due to firmware updates, the URL for the latest information may differ.)

This information is required when configuring RADIUS security manually without using the easy RADIUS security configuration feature.

▼ Website with explanations for the Yamaha SWR2311P-10G RADIUS server

https://manual.yamaha.com/pa/interfaces/swr2311p/Rev_2_02_22/en/basic/index.html#!/ap_radius_server

▼ Website with explanations for using the Yamaha SWR2311P-10G RADIUS server

https://manual.yamaha.com/pa/interfaces/swr2311p/Rev_2_02_22/en/gui/index.html#!/rds_user

Easy network security configuration

■ Web GUI Device Manager for RM-CR, RM-CG, RM-TT or RM-WAP

- [SETTINGS]→[Network]→[IEEE802.1X SETTINGS]

* When using the easy RADIUS security configuration feature, these settings are not necessary.

■ RM-CR Device Manager

- [TOOLS]→[Plugin]→[Yamaha Quick & Easy Radius Security]

About VoIP calls

What is VoIP?

VoIP (Voice over Internet Protocol) is a general term for technologies that allow telephone calls over IP networks.

SIP (Session Initiation Protocol) is a term used with the same meaning as VoIP. SIP is a communication protocol for connecting and disconnecting telephones over IP networks. The function for managing incoming and outgoing telephone calls is called call control or signaling, and uses SIP. In other words, SIP is one of the protocols that make up VoIP.

VoIP-related terms

■ SIP server

An SIP server is a server that manages and controls a telephone system using SIP.

The main role of an SIP server is to use an IP network to connect devices making calls.

VoIP-call-related settings (RM-CR Device Manager)

■ Settings required to make VoIP calls

Enable SIP and specify information for connecting to the SIP server.

- [SETTINGS] → [SIP] → [SIP SETTINGS]
 - Enable SIP
- [SETTINGS] → [SIP] → [REGISTRATION SETTINGS]
 - Registrar
 - Username
 - Password
 - User ID
 - Display name

■ Settings for conferences with multiple locations

Not only VoIP lines but also multiple lines of USB, Bluetooth and AUX can be automatically mixed. (Default setting: Enabled)

- [SETTINGS] → [Dialer] → [CONFERENCE SETTINGS]
 - Enable auto-join

■ Settings for discovering RM-CR from ProVisionaire

ProVisionaire Control and ProVisionaire Touch use the unit ID to discover an RM-CR. Set [Mode] under "HOSTNAME SETTINGS" to [Yamaha Hostname using Unit ID], and select a [Unit ID] setting.

- [SETTINGS] → [Network] → [HOSTNAME SETTINGS]
 - Mode
 - Unit ID

Remote control of VoIP calls

■ ProVisionaire Control

ProVisionaire Control is Windows application software that allows you to remotely control parameters for various devices from a single control panel. When making VoIP calls with ADECIA devices, use the dialer feature of ProVisionaire Control. A conference call routing template file can be downloaded from the ADECIA product website.

■ Remote control protocol

Information can also be obtained and ADECIA devices can also be controlled from an external device that implements a remote control protocol. For details on the protocol, refer to the RM Series Remote Control Protocol Specifications.

About SNMP/MIB

What is SNMP?

SNMP (Simple Network Management Protocol) is a protocol for managing and monitoring the connection status of devices on a network. A management tool that implements SNMP can be used to collect information such as the network status, battery status and error events of network devices.

By using RM-CR's SNMP proxy function, RM-CG, RM-TT, etc., can be accessed from a corporate network terminal via RM-CR.

What is MIB?

MIB (Management Information Base) is the database of device information held by network devices.

An MIB file describes (in a tree structure) information that can be used by SNMP.

An MIB file for ADECIA can be downloaded from the Yamaha website.

Application in an ADECIA system

From a computer, etc., a management tool that implements SNMP can be used to obtain information such as from the [Home] window of the Device Manager for RM-CR, RM-CG or RM-TT as well as collect information on connections, muting and alert notifications.

SNMP-related terms

- SNMP manager and SNMP agent

The server that collects information is the SNMP manager, and the device that provides the information is the SNMP agent.

The ADECIA device is an "SNMP agent".

- Trap

Notifications from SNMP agents are called "traps".

SNMP managers obtain status information by requesting responses from SNMP agents. Traps, on the other hand, are sent when the status changes or when some event occurs on the SNMP agent.

SNMP settings (Device Manager for RM-CR, RM-CG or RM-TT)

These are the settings in ADECIA for using an SNMP manager to monitor ADECIA devices.

- [SETTINGS]→[Admin]→[SNMP SETTINGS]

About Dante

ADECIA uses Dante as the protocol for transmitting audio signals. Dante is a protocol developed by Audinate, that features the ability to handle device control signals as well as multiple audio signals with different sampling frequencies or bit rates simultaneously in a Gigabit-Ethernet-compatible network environment.

For details on Dante, refer to the Audinate website (English).

<http://www.audinate.com/>

The Yamaha Pro Audio website also provides a variety of information regarding Dante.

<https://www.yamahaproaudio.com/>

- NOTE:** With a Dante network, do not use the EEE function* of the network switch. The EEE function may degrade clock synchronization performance and interrupt the audio. Therefore, please note the following.
- When using managed switches, turn off the EEE function on all ports used for Dante. Do not use a switch that does not allow the EEE function to be turned off.
 - When using unmanaged switches, do not use switches that support the EEE function. In such switches, the EEE function cannot be turned off.
- * EEE (Energy-Efficient Ethernet) function: Technology that reduces the power consumption of Ethernet devices during periods of low network traffic; also known as Green Ethernet or IEEE802.3az.

Dante-related settings

■ Web GUI Device Manager for RM-CR, RM-CG, RM-TT or RM-W

- [SETTINGS]→[Network]

■ Web GUI “RM-CR Device Manager”

- [TOOLS]→[Plugin]→[Yamaha network switch automatic optimization for Dante]

Updating the firmware

There are multiple ways to update the firmware.

Using RM Device Finder

RM Device Finder is application software for detecting and controlling ADECIA devices on the network. It can also be used to update the firmware of each device.

For operating procedures, refer to the RM Device Finder User Guide included with RM Device Finder.

Using the Web GUI “RM-CR Device Manager”

Firmware can be updated via [TOOLS]→[Update]→[FIRMWARE UPDATE] in the Web GUI “RM-CR Device Manager”.

For operating procedures, refer to the RM-CR RM-CG RM-TT Web GUI Device Manager Operation Guide.

- NOTE:** From the Web GUI “RM-CR Device Manager”, it is also possible to update the firmware of peripheral devices such as RM-CG and RM-TT.

The latest utility software, firmware files and manuals can be downloaded from the following website.

▼ Yamaha website (Downloads)

U.S.A. and Canada:

<https://uc.yamaha.com/support/>

Other Countries:

<https://download.yamaha.com/>

Initializing RM series devices

There are two ways to initialize an RM-CR: using the [RESET] button on the front of the unit and using the Web GUI “RM-CR Device Manager”.

For details on using the [RESET] button on the front of the unit, refer to “Controls and Functions” in this manual.

Alternatively, it can be initialized via [TOOLS]→[Configuration]→[RESET DEFAULTS] in the Web GUI “RM-CR Device Manager”. For operating procedures, refer to the RM-CR RM-CG RM-TT Web GUI Device Manager Operation Guide.

Other RM series devices can also be initialized using the [RESET] button on each device or using the corresponding device’s Web GUI Device Manager.

Updating the network switch (SWR2311P-10G) and initializing it for ADECIA

In order to use the easy RADIUS security configuration feature, the firmware of the network switch must be updated, and the ADECIA configuration file must be applied. Follow the procedure below.

IMPORTANT: If the stacking feature of the network switch is turned on, the easy RADIUS security configuration feature cannot be used. After turning off the stacking feature, update the firmware.

1. Prepare a microSD card.

In order to store the latest firmware and configuration files for the switch, prepare a microSD or microSDHC card formatted with FAT16 or FAT32.

2. Download the complete set of RADIUS security update files for the network switch (SWR2311P-10G) from the following RM-CR product website.

▼ Yamaha website (Downloads)

U.S.A. and Canada:

<https://uc.yamaha.com/support/>

Other Countries:

<https://download.yamaha.com/>

Decompress the downloaded compressed file, and then save the data to the microSD card.

The contents of the microSD card are as follows.

Folder with name of switch model (SWR2311P-10G)

|-- firmware

| | - auto-apply.txt: Auto apply file

| | - swrXXXX.bin: Firmware file

|-- startup-config

| - auto-apply.txt: Auto apply file

| - config.txt: Configuration file

3. Apply the firmware and configuration file to the switch.

3.1 After inserting the microSD card into the microSD slot on the switch, turn on the switch.

3.2 The firmware and configuration file stored on the microSD will be applied, and the device will start up. (The startup time will be longer than usual.)
When the microSD LED goes off, auto apply is finished.

3.3 When the microSD LED is off, remove the microSD card.

3.4 Restart the switch.

Note:

- Do not change switch settings with commands, the GUI, etc., while security operations are being performed using easy RADIUS security configuration. If settings are changed, this operation may not be performed correctly.
- After the switch firmware has been updated, be sure to remove the microSD card.
If the microSD card remains inserted, the firmware update and configuration file will be applied again the next time that the unit is started.

MAIN SPECIFICATIONS

General specifications

Dimensions		W215 mm × D264 mm × H44 mm
Weight		1.6 kg
Power supply		PoE+ (IEEE802.3at, LLDP), DC 48 V
Maximum power consumption		15.0 W
Temperature	Operating	0 °C – 40 °C
	Storage	-20 °C – 60 °C
Humidity	Operating	30% – 90% (non-condensing)
	Storage	20% – 90% (non-condensing)
Indicators		<ul style="list-style-type: none"> • Power • Status • Bluetooth • Network Port Indicator (×3)
Included items		Installation manual, access panel (with screw), USB cable (A-B type), USB cable (A-micro B type), rubber feet (4 pcs.)
Separately sold items		Mounting accessory: RM-MTL Mounting accessory: RM-MRK

Audio specifications

Frequency response		20 Hz – 20 kHz	
Sampling rate		48 kHz	
Bit depth		24-bit	
Latency		8 [ms] (Dante In to USB Out, including signal processing)	
Audio interface	Dante	16 in × 16 out	
	USB	USB2.0 type-B, Audio Class 1.0 Input: 2ch, Output: 2ch @48 kHz	
	Mic Input	XLR balanced, Input 2ch	
	AUX	RCA unbalanced (Line Level), Input: 2ch, Output: 2ch	
	Speaker Out	RCA unbalanced (Line Level), Output: 2ch	
	Bluetooth	Version 4.2 Supported protocols: HFP (1.6), A2DP, AVRCP (1.6) Supported codecs: CVSD, SBC, mSBC Wireless output: Class 2 Maximum communication distance: 10 meters (no obstructions) Wireless frequencies (operating frequencies): 2,402 – 2,480 MHz Maximum output power (EIRP): 4.0 dBm (2.5 mW) Modulation methods: GFSK, $\pi/4$ DQPSK, 8DPSK	
	SIP	Call Handling	Dial, Answer, Hold, Resume, Forwarding, Do not disturb, Call ID, Voice Mail Notifications (switch configured)
		Call Bridging	Supports Bridging SIP, USB, BT and AUX Calls. Join, Split, Hold, Resume, 5+1 Lines: Up to 2 SIP calls, 1 USB call, 1 Bluetooth call, 1 AUX, plus the user
		Codecs	G.711, G.722HD, G.729ab, G.726
		DTMF Support	RTP event, SIP in-band, SIP info package
Security		SRTP Support (RFC 1889), IETF SIP support (RFC 3261 and companion RFCs)	

Network specifications

[Dante/PoE] port	Dante Audio/Dante Control, remote control, WebUI, PoE+ supported Cable requirements: CAT5e or higher, STP
Network ports	Corporate Network, remote control, SIP, WebUI Cable requirements: CAT5e or higher, STP
[SETUP] port	USB2.0 micro, Network Class, WebUI, fixed IP Cable requirement: USB cable (A-micro B type)

Input/output characteristics

Input Terminal	Actual Load Impedance	For Use With Nominal	Input Level		Connector
			Nominal	Max. Before Clip	
MIC IN 1, 2	2.2 k Ω	50 – 600 Ω	–46 dBu	–26 dBu	XLR-3-31 (Balanced)
AUX IN L, R	20 k Ω	1 k Ω	–14 dBV	+6 dBV	RCA PIN

Output Terminal	Actual Source Impedance	For Use With Nominal	Output Level		Connector
			Nominal	Max. Before Clip	
AUX OUT L, R	1 k Ω	10 k Ω	–14 dBV	+6 dBV	RCA PIN
SP OUT L, R	1 k Ω	10 k Ω	–14 dBV	+6 dBV	RCA PIN