

# PSR-SX9000

# PSR-SX7000

Digital Workstation

## Reference Manual

This Reference Manual explains advanced features of the PSR-SX900/SX700.  
Please read the Owner's Manual first, before reading this Reference Manual.

# Contents

<b>Function List</b>	<b>4</b>
<b>1 Styles</b>	<b>6</b>
Style Types (Characteristics) .....	6
Registering Files to the Favorite Tab .....	7
Changing the Chord Fingering Type .....	8
Chord Types Recognized in the Fingered Mode .....	9
Using the Chord Tutor Function .....	10
Turning Each Channel of the Style On/Off .....	11
Style Playback Related Settings .....	12
Adjusting the Tempo .....	13
Recording a Chord Sequence when Style Playback is stopped (Chord Looper) (PSR-SX900) .....	14
Saving and Calling up Your Custom Chord Sequences (Chord Looper) (PSR-SX900) .....	15
Creating/Editing Styles (Style Creator) .....	18
<b>2 Voices</b>	<b>32</b>
Voice Part Setup Display .....	32
Voice Selection Display-related Settings .....	34
Voice Types (Characteristics) .....	35
Registering Files to the Favorite Tab .....	36
Metronome Settings .....	36
Keyboard/Joystick-related Settings .....	37
Keyboard Part-related Settings (Voice Setting) .....	39
Transposing the Pitch in Semitones .....	40
Fine Tuning the Pitch of the Entire Instrument (Master Tune) .....	41
Selecting or Creating a Temperament (Scale Tune) .....	41
Making Detailed Settings for Harmony/Arpeggio .....	44
Editing Voices (Voice Edit) .....	46
Editing Organ Flutes Voices (Voice Edit) .....	50
<b>3 Multi Pads</b>	<b>52</b>
Creating a Multi Pad via MIDI (Multi Pad Creator—MIDI Multi Pad Recording) .....	52
Creating a Multi Pad with Audio files (Multi Pad Creator—Audio Link Multi Pad) .....	54
Editing Multi Pads .....	56
<b>4 Song Playback</b>	<b>57</b>
Creating a Song List for Playback .....	57
Using Repeat Playback Mode .....	58
Editing Music Notation (Score) Settings .....	59
Displaying Lyrics and Setting Up the Display .....	61
Displaying Text and Setting Up the Display .....	62
Using the Auto Accompaniment Features with MIDI Song Playback .....	63
Turning Each Channel of a MIDI Song On/Off .....	64
Song Playback Related Settings .....	65
<b>5 MIDI Song Recording/Editing</b>	<b>67</b>
Overview of MIDI Song Recording .....	67
Recording Each Channel Individually (Realtime Recording) .....	69
Re-recording a Specific Section—Punch In/Out (Realtime Recording) .....	71
Recording Panel Setups to a Song .....	73
Editing Channel Events of Existing Song Data .....	74
Step Recording/Editing Songs (Step Edit) .....	77
<b>6 Registration Memory</b>	<b>86</b>
Disabling Recall of Specific Items (Registration Freeze) .....	86
Calling Up Registration Memory Numbers in Order (Registration Sequence) .....	87
Searching for a Registration Memory Bank File .....	89
<b>7 Playlist</b>	<b>91</b>
Importing Music Finder Records to the Playlist .....	91
<b>8 Microphone</b>	<b>93</b>
Making the Microphone or Guitar Settings (Mic Setting) .....	93
Editing the Vocal Harmony Type (Vocal Harmony) (PSR-SX900) .....	96
Editing the Synth Vocoder Types (Vocal Harmony) (PSR-SX900) .....	100

<b>9 Mixer</b>	<b>102</b>
Editing Filter Parameters (Filter) .....	102
Editing EQ Parameters (EQ) .....	103
Editing Effect Parameters (Effect) .....	105
Editing Effect Parameters (Chorus/Reverb) .....	107
Editing Pan/Volume Settings (Pan/Volume) .....	107
Editing Master Compressor Settings (Compressor) .....	108
Block Diagram .....	110
<b>10 Controller Function Settings</b>	<b>111</b>
Assigning Specific Functions to the Pedals and Panel Buttons (Assignable) .....	111
Editing the Assign Types of the Live Control Knobs (Live Control) .....	117
<b>11 MIDI Settings</b>	<b>120</b>
Basic Procedure for MIDI Settings .....	120
System—MIDI System Settings .....	122
Transmit—MIDI Transmit Channel Settings .....	123
Receive—MIDI Receive Channel Settings .....	124
On Bass Note—Setting the Bass Note for Style Playback via MIDI .....	125
Chord Detect—Settings for Chords used in Style Playback via MIDI .....	125
<b>12 Network Settings</b>	<b>126</b>
Wireless LAN Settings .....	126
Making the Time Settings .....	128
<b>13 Utility</b>	<b>129</b>
Speaker/Connectivity (PSR-SX900), Speaker (PSR-SX700) .....	129
Touch Screen/Display .....	130
Parameter Lock .....	130
Storage—Formatting the Drive .....	130
System .....	131
Factory Reset/Backup .....	132
<b>14 Expansion Pack Related Operations</b>	<b>134</b>
Installing Expansion Pack Data from a USB Flash Drive .....	134
Saving the Instrument Info File to a USB Flash Drive .....	135
Restoring the Pre-installed Expansion Contents .....	135
<b>15 Connections</b>	<b>136</b>
Selecting the Output Destination of Each Sound (Line Out) (PSR-SX900) .....	136
<b>Index</b>	<b>138</b>

### Using the PDF manual

- To quickly jump to items and topics of interest, click on the desired items in the “Bookmarks” index to the left of the main display window. (Click the “Bookmarks” tab to open the index if it is not displayed.)
- Click the page numbers that appear in this manual to go directly to the corresponding page.
- Select “Find” or “Search” from the Adobe Reader “Edit” menu and enter a keyword to locate related information in the document. The names and positions of menu items may vary according to the version of Adobe Reader being used.

 **NOTE**

The names and positions of menu items may vary according to the version of Adobe Reader being used.

- The illustrations and LCD screens as shown in this manual are for instructional purposes only, and may appear somewhat different from those on your instrument. Note that all display examples shown in this manual are in English.
- Even though the example screens and illustrations pertain to the PSR-SX900, the usage is the same for the PSR-SX700.
- The displays are taken from the PSR-SX900, and are in English.
- The “Data List” and “Smart Device Connection Manual for iOS (iPhone/iPad Connection Manual)” documents can be downloaded from the Yamaha website:  
<https://download.yamaha.com>
- The company names and product names in this manual are the trademarks or registered trademarks of their respective companies.

# Function List

This section simply and very briefly explains what you can do in the displays called up by pressing the buttons on the panel, or by touching each icon on the Menu display.

For more information, refer to the page indicated below or the Owner's Manual. The “●” mark indicates that the function is described in the Owner's Manual.

## Displays accessible by the panel buttons

Display	Button to access	Description	Pages	Owner's Manual
Home	[DIRECT ACCESS] + [EXIT]	Portal of the instrument's display structure, which provides at-a-glance information on all current settings.	-	●
Menu	[MENU]	By touching each of the icons, you can call up the menus for the various functions listed below.	-	●
Style Selection	STYLE category selection buttons	For selecting Style files.	-	●
Song Player	SONG [PLAYER]	For controlling Song playback.	57	●
Playlist	[PLAYLIST]	For selecting and editing Playlists, and managing your repertoire.	91	●
Song Recording	SONG [RECORDING]	For recording your performance.	68	●
Mixer	[MIXER/EQ]	For adjusting the parameters of each part, such as volume, pan, and EQ. It also allows you to adjust overall sound controls, such as Master Compressor and Master EQ.	102	●
Voice Selection	PART SELECT [LEFT]-[RIGHT 3], VOICE category selection buttons	For assigning Voices to each of the keyboard parts.	-	●
Multi Pad Selection	MULTI PAD CONTROL [SELECT]	For selecting Multi Pads.	56	●
Registration Memory Bank Selection	REGIST BANK SELECT [-] and [+]	For selecting Registration Memory Banks.	87	●
Registration Memory window	[MEMORY]	For registering the current panel settings.	-	●

## Menu display functions

Menu	Description	Pages	Owner's Manual
Channel On/Off	For turning each channel of Style or MIDI Song on and off.	11, 64	-
Voice Part Setup	For confirming the current Voice settings, and making Voice-related settings such as Effects.	32	-
Line Out (PSR-SX900)	Determines which jack is used to output each part and each drum & percussion instrument.	136	-
Score	For displaying the music notation (score) of the current MIDI Song.	59	●
Lyrics	For displaying the lyrics of the current Song.	61	●
Text Viewer	For displaying text files created on your computer.	62	-
Chord Looper (PSR-SX900)	For recording a sequence of the chords and playing it back in a loop.	14, 15	●
Mic Setting	For making microphone sound settings.	93	●
Vocal Harmony (PSR-SX900)	For adding Vocal Harmony effects to your singing. You can edit the Vocal Harmony and save as your original harmony.	96, 100	●
Kbd Harmony/Arp	For adding the Harmony/Arpeggio effect to the right-hand section of the keyboard. Parameters such as Harmony/Arpeggio type can be set.	44	●
Split & Fingering	For setting the Split Point or change the Chord Fingering type and Chord Detection area.	8	●
Regist Sequence	Determines the order for calling up Registration Memory settings when using the pedal.	87	-
Regist Freeze	Determines the item(s) that remain unchanged even when you call up panel setups from the Registration Memory.	86	-
Tempo	For adjusting the tempo of MIDI Song, Style or Metronome. The same operation as using the TEMPO [-]/[+] and [RESET/TAP TEMPO] buttons can be done on the display.	13	●



Menu	Description	Pages	Owner's Manual
<b>Metronome</b>	For making settings of the metronome and the [RESET/TAP TEMPO] button.	36	●
<b>Live Control</b>	Determines the functions assigned to the Live Control knobs.	117	●
<b>Assignable</b>	Determines the functions assigned to the pedals, assignable buttons, and the shortcuts on the Home display.	111	●
<b>Panel Lock</b>	For locking the panel settings. When the panel settings are locked, the instrument cannot be operated.	-	●
<b>Demo</b>	For calling up the Demo display.	-	●
<b>Voice Edit</b>	For editing the preset Voices to create your own Voices. The display differs depending on whether an Organ Flutes Voice or another kind of Voice is selected.	46, 50	-
<b>Style Creator</b>	For creating a Style by editing the preset Style, or by recording Style channels one by one.	18	-
<b>Song Recording</b>	For recording your performance. (This is same as the [RECORDING] button on the panel.)	67	●
<b>M.Pad Creator</b>	For creating a Multi Pad by editing an existing preset Multi Pad, or by recording a new one.	52, 54	-
<b>Voice Setting</b>	For making detailed settings of the keyboard parts, such as the pitch for each part, Voice Set filter, and Arpeggio related settings.	39	-
<b>Style Setting</b>	For making Style playback related settings such as OTS Link timing, Dynamics Control, etc.	12	-
<b>Song Setting</b>	For making Song playback related settings such as Guide function, Channel settings, etc.	65	-
<b>Chord Tutor</b>	Indicates how to play chords that correspond to the specified chord names.	10	-
<b>Scale Tune</b>	For setting the scale type.	41	-
<b>Master Tune</b>	For fine-tuning the pitch of the entire instrument.	41	-
<b>Transpose</b>	For transposing the pitch of the entire sound in semitones, or just the sound of the keyboard or MIDI Song.	40	●
<b>Keyboard/Joystick</b>	Determines the Touch Response of the keyboard and Joystick-related settings.	37	-
<b>Expansion</b>	For installing Expansion Packs for adding extra contents downloaded from the website or created on your own by using the Yamaha Expansion Manager, or restoring the pre-installed Expansion Contents.	134	-
<b>MIDI</b>	For making MIDI-related settings.	120	-
<b>Utility</b>	For making global settings, managing the USB flash drives, initializing the instrument to the factory default, or backing up the data stored in the instrument, etc.	129	●
<b>Bluetooth</b> <sup>*1</sup> (PSR-SX900)	For making settings for connecting the instrument to a Bluetooth-equipped device.	-	●
<b>Time</b> <sup>*2</sup>	For making settings of the time shown on the Home display.	128	-
<b>Wireless LAN</b> <sup>*2</sup>	For making settings for connecting the instrument to a computer or a smart device such as iPad via the wireless LAN function.	126	-

<sup>\*1</sup> This icon appears only when the Bluetooth function is included.

<sup>\*2</sup> This icon appears only when the optional USB Wireless LAN adaptor is connected.

## Contents

Style Types (Characteristics) .....	6
Registering Files to the Favorite Tab.....	7
• Removing Files from the Favorite Tab .....	7
Changing the Chord Fingering Type .....	8
Chord Types Recognized in the Fingered Mode .....	9
Using the Chord Tutor Function .....	10
Turning Each Channel of the Style On/Off .....	11
Style Playback Related Settings.....	12
• Setting.....	12
• Change Behavior .....	13
Adjusting the Tempo.....	13
Recording a Chord Sequence when Style Playback is stopped (Chord Looper) (PSR-SX900) .....	14
Saving and Calling up Your Custom Chord Sequences (Chord Looper) (PSR-SX900) .....	15
• Memorizing the Recorded Chord Looper Data .....	15
• Saving the Recorded Data as a Bank File.....	16
• Recalling the Chord Looper Bank File and Playing Back a Style with a Chord Sequence .....	16
• Editing the Chord Looper Bank (Export, Import, Clear) .....	17
Creating/Editing Styles (Style Creator) .....	18
• Style Data Structure—Consisting of Source Patterns .....	18
• Basic Procedure for Creating a Style.....	19
• Realtime Recording .....	20
• Step Recording .....	23
• Assembly—Assigning the Source Pattern to Each Channel .....	24
• Channel Edit .....	24
• SFF Edit—Making Style File Format Settings.....	26
• Editing the Rhythm Part of a Style (Drum Setup).....	30

## Style Types (Characteristics)

The particular type of Style is indicated the upper left of the Style name in the Style Selection display. The defining characteristics of these Styles and their performance advantages are described below.



Session	For information on these types, refer to “Style Characteristics” in the Owner’s Manual.
Free Play	
DJ	
+Audio (PSR-SX900)	<p>The Audio Styles (+Audio) have been specially produced by adding audio recordings of studio musicians playing in various recording studios worldwide. This adds exceptionally natural feel, ambience and warmth to the drums and percussion of the Style, giving your performance greater expressive potential. Specifically, it retains the subtle nuances and grooves that are difficult to reproduce using the preset drum/percussion kit. Yamaha Time Stretch Technology allows the audio to follow your tempo changes without changing pitch, so everything stays in perfect sync. Audio Styles can be played back and controlled by this instrument; however, by default the data is not included on this instrument. Audio Styles or Expansion Packs that contain Audio Styles may be available at the Yamaha website.</p> <p><b>NOTE</b></p> <ul style="list-style-type: none"> <li>• If the tempo is set to over 160% of the default, the audio part is muted.</li> <li>• Keep in mind that the Audio Styles may take more time to load than others, and that they may have certain restrictions and differ in the specific functions that can be handled.</li> </ul>

## Registering Files to the Favorite Tab

You can call up your favorite or often used preset Styles or Voices quickly by registering them to the Favorite tab on the File Selection display.

**1** In the File Selection display, select the desired category in the Preset tab.

**2** Touch  (File) to call up the “File Edit” window.

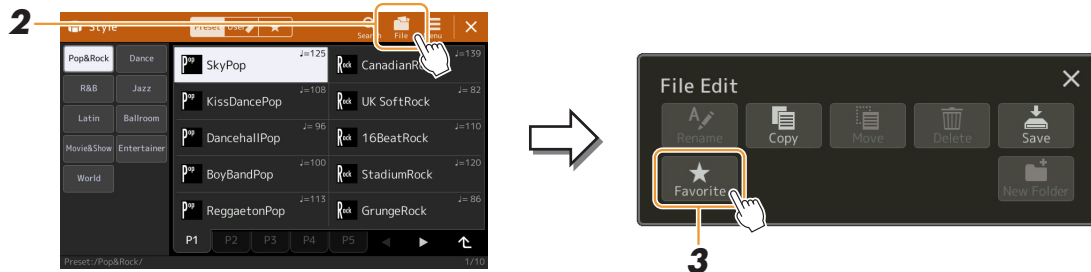

**3** Touch [Favorite] to call up the display for selecting the files.

**4** Select the desired files for registering to the Favorite tab.

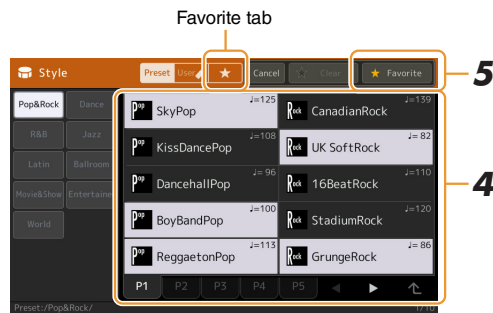

**5** Touch [Favorite] to actually register the files to the Favorite tab.

The selected files are shown on the Favorite tab.

## Removing Files from the Favorite Tab

**1** In the Favorite tab of the File Selection display, touch  (File) to call up the “File Edit” window.

**2** Touch [Favorite] to call up the display for selecting the files.

**3** Select the files which you want to remove from the Favorite tab.



**4** Touch [Clear] to actually remove the files from the Favorite tab.

## Changing the Chord Fingering Type

The Chord Fingering type determines how chords are specified for Style Playback. You can select the desired type on the display called up via [MENU] → [Split & Fingering].

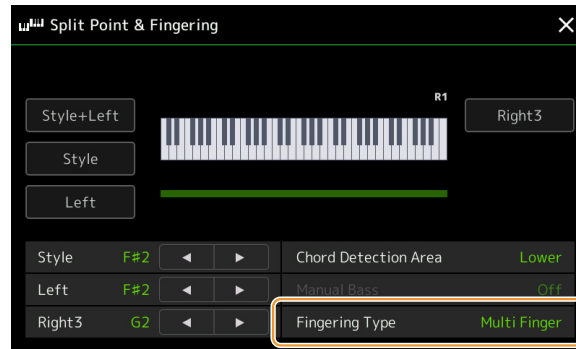

Single Finger	<p>Makes it simple to produce orchestrated accompaniment using major, seventh, minor and minor-seventh chords by pressing only one, two or three keys on the Chord section of the keyboard.</p> <div style="display: flex; flex-wrap: wrap;"> <div style="width: 50%;"> <p><b>C</b></p> <p><b>Major chord</b> Press the root key only.</p> </div> <div style="width: 50%;"> <p><b>C7</b></p> <p><b>Seventh chord</b> Simultaneously press the root key and a white key to its left.</p> </div> <div style="width: 50%;"> <p><b>Cm</b></p> <p><b>Minor chord</b> Simultaneously press the root key and a black key to its left.</p> </div> <div style="width: 50%;"> <p><b>Cm7</b></p> <p><b>Minor Seventh chord</b> Simultaneously press the root key and both a white and black key to its left.</p> </div> </div>
Multi Finger	Automatically detects Single Finger or Fingered chord fingerings, so you can use either type of fingering without having to switch fingering types.
Fingered	Lets you specify the chord by pressing the notes making up a chord in the left hand section of the keyboard when ACMP is turned on or the Left part is turned on. For information on which notes to press for each chord, refer to the Data List (Chord Types Recognized in the Fingered Mode) downloadable from Yamaha Manual Library, or use the Chord Tutor function as described in the next section.
Fingered On Bass	Accepts the same fingerings as Fingered; however, the lowest note played in the Chord section of the keyboard is used as the bass note, allowing you to play “on bass” chords. (In the Fingered type, the root of the chord is always used as the bass note.)
Full Keyboard	Detects chords in the entire key range. Chords are detected in a way similar to Fingered, even if you split the notes between your left and right hands—for example, playing a bass note with your left hand and a chord with your right, or by playing a chord with your left hand and a melody note with your right.
AI Fingered	Basically the same as Fingered, with the exception that less than three notes can be played to indicate the chords (based on the previously played chord, etc.).
AI Full Keyboard	This type is similar to Full Keyboard, with the exception that less than three notes can be played to indicate the chords (based on the previously played chord, etc.). 9th, 11th and 13th chords cannot be played.

### NOTE

- “AI” stands for “Artificial Intelligence.”
- When the chord detection area is set to “Upper,” only “Fingered\*” is available. This type is basically same as “Fingered,” except that “1+5,” “1+8” and Chord Cancel are not available.

# Chord Types Recognized in the Fingered Mode

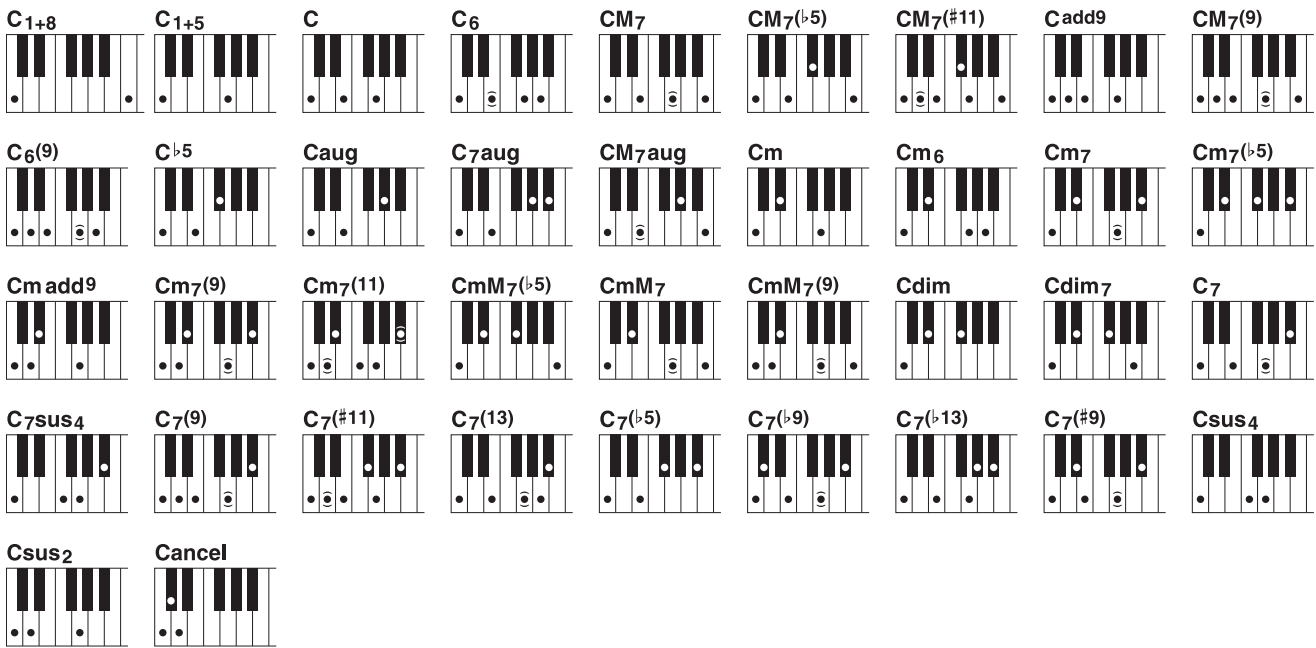

Chord Name [Abbreviation]	Normal Voicing	Display for root "C"
1+8	1+8	C1+8
1+5	1+5	C1+5
Major [M]	1+3+5	C
Sixth [6]	1+(3)+5+6	C6
Major seventh [M7]	1+3+(5)+7	CM7
Major seventh flattened fifth [M7b5]	1+3+b5+7	CM7(b5)
Major seventh add sharp eleventh [M7(#11)]	1+(2)+3+#4+5+7	CM7(#11)
Add ninth [(9)]	1+2+3+5	Cadd9
Major seventh ninth [M7_9]	1+2+3+(5)+7	CM7(9)
Sixth ninth [6_9]	1+2+3+(5)+6	C6(9)
Flatted fifth [(b5)]	1+3+b5	Cb5
Augmented [aug]	1+3+#5	Caug
Seventh augmented [7aug]	1+3+#5+b7	C7aug
Major seventh augmented [M7aug]	1+(3)+#5+7	CM7aug
Minor [m]	1+b3+5	Cm
Minor sixth [m6]	1+b3+5+6	Cm6
Minor seventh [m7]	1+b3+(5)+b7	Cm7
Minor seventh flattened fifth [m7b5]	1+b3+b5+b7	Cm7(b5)
Minor add ninth [m(9)]	1+2+b3+5	Cm add9
Minor seventh ninth [m7(9)]	1+2+b3+(5)+b7	Cm7(9)
Minor seventh eleventh [m7(11)]	1+(2)+b3+4+5+(b7)	Cm7(11)
Minor major seventh flattened fifth [mM7b5]	1+b3+b5+7	CmM7(b5)
Minor major seventh [mM7]	1+b3+(5)+7	CmM7
Minor major seventh ninth [mM7(9)]	1+2+b3+(5)+7	CmM7(9)
Diminished [dim]	1+b3+b5	Cdim
Diminished seventh [dim7]	1+b3+b5+6	Cdim7
Seventh [7]	1+3+(5)+b7	C7
Seventh suspended fourth [7sus4]	1+4+5+b7	C7sus4
Seventh ninth [7(9)]	1+2+3+(5)+b7	C7(9)
Seventh add sharp eleventh [7(#11)]	1+(2)+3+#4+5+b7	C7(#11)
Seventh add thirteenth [7(13)]	1+3+(5)+6+b7	C7(13)
Seventh flatted fifth [7b5]	1+3+b5+b7	C7(b5)
Seventh flatted ninth [7(b9)]	1+b2+3+(5)+b7	C7(b9)
Seventh add flatted thirteenth [7(b13)]	1+3+5+b6+b7	C7(b13)
Seventh sharp ninth [7(#9)]	1+#2+3+(5)+b7	C7(#9)
Suspended fourth [sus4]	1+4+5	Csus4
One plus two plus five [sus2]	1+2+5	Csus2
cancel	1+b2+2	Cancel

• Notes in parentheses can be omitted.

## Using the Chord Tutor Function

The Chord Tutor function lets you see which notes to press for specifying the chord. If you know a chord name but don't know how to play it, use this function.

This function can be used on the display called up via [MENU] → [Chord Tutor].

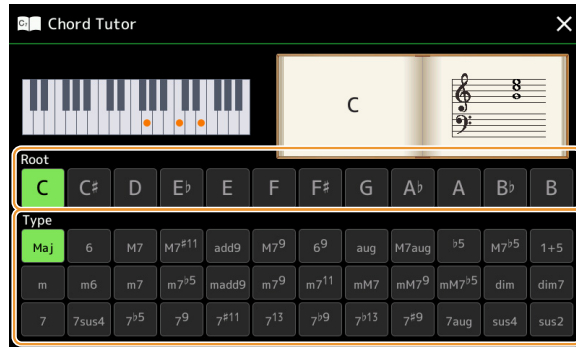

Root	Lets you select the desired chord root.
Type	Lets you select the desired chord type.

The notes you need to play are shown in the display.

### NOTE

- Although this function shows how to play a chord only in case of "Fingered," the indication is useful also when a type other than "Single Finger" is selected.
- Depending on the chord, some notes will be omitted.

## Turning Each Channel of the Style On/Off

You can add variations and change the feeling of a Style by selectively turning channels on/off as the Style plays.

### Style channels

Each Style contains the channels listed below.

- **Rhythm 1/2:** These are the basic parts of the Style, containing the drum and percussion rhythm patterns.
- **Bass:** The bass part uses various appropriate instrument sounds to match the Style.
- **Chord 1/2:** These parts are for rhythmic chord backing, commonly consisting of piano or guitar Voices.
- **Pad:** This part is used for sustained instruments such as strings, organ, choir, etc.
- **Phrase 1/2:** These parts are used for punchy brass stabs, arpeggiated chords, and other extras that make the accompaniment more interesting.

### (PSR-SX900)

- **Audio:** This is an audio part of the Audio Style.

Style channels can be turned on or off on the display called up via [MENU] → [Channel On/Off].

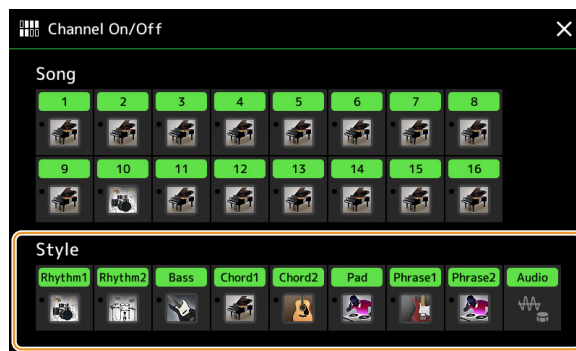

If you want to play back only one particular channel (solo playback), touch and hold the desired channel name until it turns purple. To cancel solo, simply touch the (purple) channel name again.

### NOTE

You can also turn the channels on/off on the Mixer display.

### To change the Voice for each channel:

Touch the instrument icon below the desired channel to call up the Voice Selection display, then select the desired Voice.

### NOTE

(PSR-SX900) The Voice of the Audio part of the Audio Style cannot be changed.

### NOTE



You can save the settings here to Registration Memory. For details, refer to the Owner's Manual.

# Style Playback Related Settings

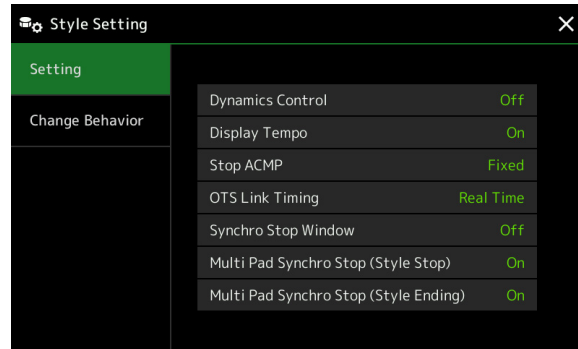
You can make a variety of settings for Style Playback, on the display called up via [MENU] → [Style Setting].



## Setting

Dynamics Control	<p>This determines how the Style playback volume changes depending on the playing strength.</p> <ul style="list-style-type: none"> <li>• <b>Off:</b> The volume is kept the same regardless of playing strength.</li> <li>• <b>Narrow:</b> The volume changes over a narrow range.</li> <li>• <b>Medium:</b> The volume changes over a medium range.</li> <li>• <b>Wide:</b> The volume changes over a wide range.</li> </ul>
Display Tempo	<p>Turns the tempo indication on or off for each Style on the Style Selection display.</p>
Stop ACMP	<p>When the [ACMP] button is turned on and the [SYNC START] button is off, you can play chords in the chord section of the keyboard with the Style stopped, and still hear the accompaniment chord. In this condition—called “Stop Accompaniment”—any valid chord fingerings are recognized and the chord root/type are shown in the Style area of the Home display. Here, you can determine whether the chord played in the chord section will sound or not in the Stop Accompaniment status.</p> <ul style="list-style-type: none"> <li>• <b>Off:</b> The chord played in the chord section will not sound.</li> <li>• <b>Style:</b> The chord played in the chord section will sound via the Voices for the Pad channel and the Bass channel of the selected Style.</li> <li>• <b>Fixed:</b> The chord played in the chord section will sound via the specified Pad/Bass channels’ Voices, regardless of the selected Style.</li> </ul> <p> <b>NOTE</b> When the selected Style contains MegaVoices, unexpected sounds may result when this is set to “Style.”</p> <p> <b>NOTE</b> When you record a Song, the chord detected by playing the Stop Accompaniment can be recorded regardless of the setting here. Please note that both the sounding Voice and chord data is recorded when set to “Style,” and only the chord data is recorded when set to “Off” or “Fixed.”</p>
OTS Link Timing	<p>This applies to the OTS Link function. This parameter determines the timing in which the One Touch Settings change with the MAIN VARIATION [A]–[D] change. (The [OTS LINK] button must be on.)</p> <ul style="list-style-type: none"> <li>• <b>Real Time:</b> One Touch Setting is immediately called up when you press a MAIN VARIATION button.</li> <li>• <b>Next Bar:</b> One Touch Setting is called up at the next measure, after you press a MAIN VARIATION button.</li> </ul>
Synchro Stop Window	<p>This determines how long you can hold a chord before the Synchro Stop function is automatically cancelled. When the [SYNC STOP] button is turned on and this is set to a value other than “Off,” the Synchro Stop function is automatically cancelled if you hold a chord for longer than the time set here. This conveniently resets Style playback control to normal, letting you release the keys and still have the Style play. In other words, if you release the keys more quickly than the time set here, the Synchro Stop function works.</p>



Multi Pad Synchro Stop (Style Stop)	Determines whether or not the repeat playback of a Multi Pad stops when Style playback is stopped.
Multi Pad Synchro Stop (Style Ending)	Determines whether or not the repeat playback of a Multi Pad stops when the Ending section of Style is played back.

## Change Behavior

Section Set	Determines the default section that is automatically called up when selecting different Styles (when Style playback is stopped). When set to “Off” and Style playback is stopped, the active section is maintained even if a different Style is selected. When any of the MAIN A–D sections are not included in the Style data, the nearest section is automatically selected. For example, when MAIN D is not contained in the selected Style, MAIN C will be called up.
Tempo	This determines whether the tempo changes or not when you change the Style. <ul style="list-style-type: none"> <li>• <b>Lock:</b> Regardless of playback status, the tempo setting of the previous Style is maintained.</li> <li>• <b>Hold:</b> While the Style is playing back, the tempo setting of the previous Style is maintained. While the Style is stopped, the tempo changes to that of the default tempo of the selected Style.</li> <li>• <b>Reset:</b> Regardless of playback status, the tempo changes to that of the default tempo for the selected Style.</li> </ul>
Part On/Off	This determines whether the Style Channel on/off status changes or not when you change the Style. <ul style="list-style-type: none"> <li>• <b>Lock:</b> Regardless of playback status, the Channel on/off status of the previous Style is maintained.</li> <li>• <b>Hold:</b> While the Style is playing back, the Channel on/off status of the previous Style is maintained. While the Style is stopped, all Channels of the selected Style are set to on.</li> <li>• <b>Reset:</b> Regardless of playback status, all Channels of the selected Style are set to on.</li> </ul>

## Adjusting the Tempo

You can adjust the tempo of Style, MIDI Song and metronome, on the display called up via [MENU] → [Tempo], or by rotating the Data dial on the Home display.

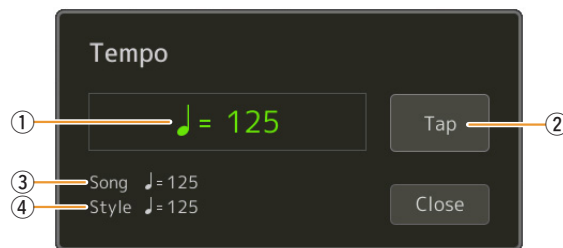

①	Indicates the tempo value during playback of the metronome, Style and MIDI Song. The tempo can be changed by using the Data dial, the [DEC]/[INC] buttons or the TEMPO [-]/[+] buttons. <p><b>NOTE</b> (PSR-SX900) When you select an Audio Style (page 6), the upper limit of the tempo will be shown below the tempo value in this way: Audio: ** max. The Audio part is muted if the tempo is over the upper limit.</p>
②	Allows you to change the tempo by tapping this twice at the desired tempo. (Equivalent to the [RESET/TAP TEMPO] button when the “Style Section Reset” setting (page 36) is off.)
③	Indicates the tempo value of the current MIDI Song. The Song will be started at this tempo.
④	Indicates the tempo value of the current Style. The Style will be started at this tempo.

### **NOTE**

The tempo value of an Audio Song is set via the Time Stretch function. Refer to the Owner's Manual.

## Recording a Chord Sequence when Style Playback is stopped (Chord Looper) (PSR-SX900)

You can start recording and playing back a chord sequence when Style playback is stopped, using SYNC START. By recording this way, you can adjust the start timing to exactly the first beat of the measure.

### 1 While Style playback is stopped, press the CHORD LOOPER [REC/STOP] button.

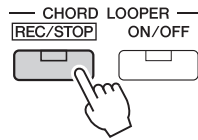

The [REC/STOP] button flashes to indicate the Chord Looper function is on standby to record, and the STYLE CONTROL [SYNC START] button is automatically turned on.

#### NOTE

When [REC/STOP] is turned on, the [ACMP] button is also turned on automatically.

### 2 Enter the chords on the keyboard according to the playback tempo of the Style.



Recording and Style playback starts simultaneously. The chord sequence is recorded until you stop recording in step 3.

### 3 Press the STYLE CONTROL [START/STOP] button to stop recording and Style playback.

Recording stops, and the CHORD LOOPER [ON/OFF] button lights in blue to indicate the data is already recorded.

#### NOTE

You can also stop recording by pressing the CHORD LOOPER [REC/STOP] button. In this case, only the recording stops, while Style playback will continue.

#### **NOTICE**

The latest chord sequence data you recorded is maintained unless you turn the power off or select a Chord Looper Memory number which contains data. If you want to save the data, see [page 15](#).

# Saving and Calling up Your Custom Chord Sequences (Chord Looper) (PSR-SX900)

On the Chord Looper display, you can memorize the recorded chord sequence of the Chord Looper function to one of the eight memories for easy recall. You can save all eight memorized data slots as a single Chord Looper Bank (\*.clb) file or export a single memory as a Chord Looper Data (\*.cld) file. Operation display is called up via: [MENU] → [Chord Looper].

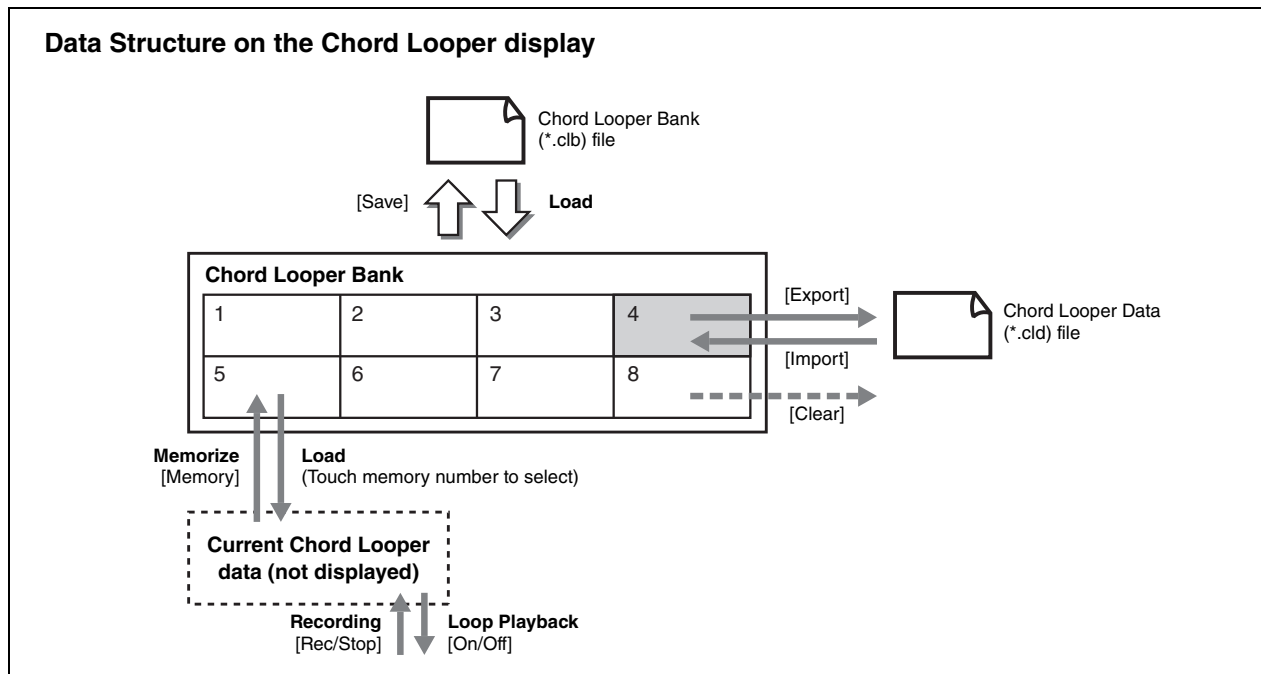

This section covers how to memorize, save/recall, and export/import the recorded data.

## Memorizing the Recorded Chord Looper Data

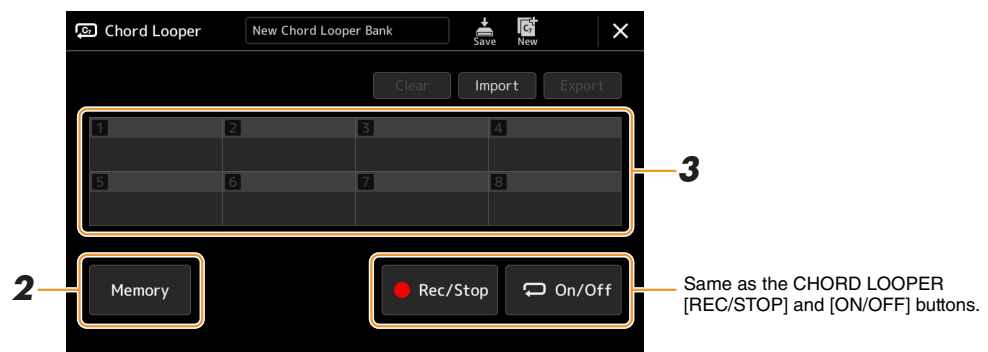

### 1 Record the desired chord sequence.

For details on recording the chord sequence, see [page 14](#) or refer to the Owner's Manual.

### 2 Touch [Memory] on the Chord Looper display.

A guidance message appears on the display.

### 3 Touch the desired number to memorize.

The data is memorized, and the content of the memorized data is shown on the corresponding area.

#### **NOTICE**

If you turn the power off at this point, the Memory will be cleared. To save the memorized data as a file, see [pages 16 and 17](#).

## Saving the Recorded Data as a Bank File

The eight memorized chord sequences are can be saved as a single Chord Looper Bank (\*.clb) file.

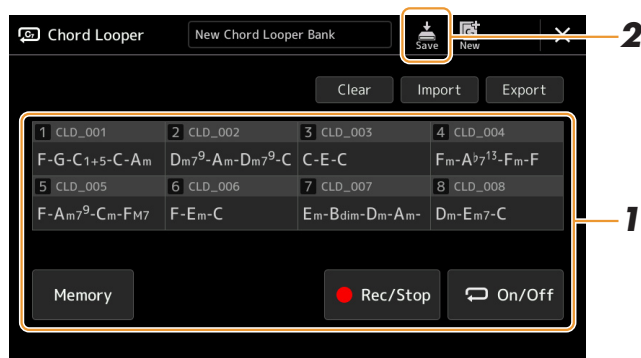

### 1 Record the desired chord sequence, and then memorize to the number [1]–[8].

To record the chord sequence, see [page 14](#) or refer to the Owner's Manual.  
To memorize the recorded data, see [page 15](#).

### 2 Touch (Save) to save the data in the Chord Looper Memory [1]–[8] as a single Bank file.

#### NOTICE

If you select a Chord Looper Bank file before saving the edited data, the data will be lost.

#### NOTE

Each Chord Looper Memory is named automatically such as "CLD\_001," but it can be renamed by exporting the file and import it ([page 17](#)).

## Recalling the Chord Looper Bank File and Playing Back a Style with a Chord Sequence

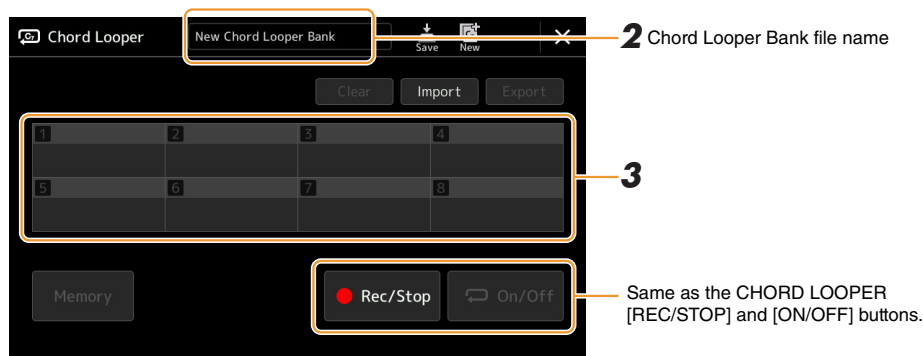

### 1 Select a Style.

### 2 Load the Chord Looper Bank name to call up the Chord Looper Bank Selection display, and then select the desired Bank.

### 3 Touch the Chord Looper Memory number you wish to use first.

#### NOTE

Touch [On/Off] to turn it on here, if you want to start automatic Style playback from the beginning of your performance.

#### 4 Start playback of the Style and play along with it.

#### 5 Turn on [On/Off] just before the measure you want to start loop playback of the chord sequence.

[On/Off] flashes to indicate loop playback is in standby. On the next measure of the Style, [On/Off] is turned on and the chord sequence will be played back in a loop.

#### NOTE

During loop playback, [On/Off] lights (and the CHORD LOOPER [ON/OFF] lights in orange), and the [ACMP] button flashes. In this condition, the chord input from the keyboard is disabled, and the whole keyboard can be used for performance.

#### 6 As necessary, change the Chord Looper Memory number.

To change the Memory number, touch the desired number. The chord sequence changes on the next measure of the Style.

#### 7 Touch [On/Off] to stop loop playback.

The playback of the chord sequence is immediately stopped, and the Style will return to normal playback.

## Editing the Chord Looper Bank (Export, Import, Clear)

Each Chord Looper Memory number contained in the Chord Looper Memory Bank can be edited (cleared, imported, and exported) one by one. The Memory data is exported/imported as a Chord Looper Data (\*.cld) file.

#### NOTE

If you want to clear all data shown in the Chord Looper display, touch  (New) to create the new Bank.

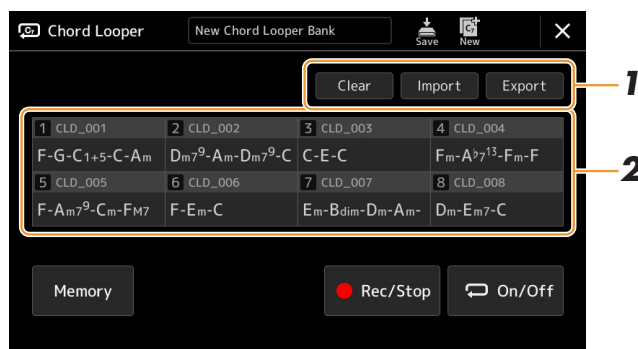

#### 1 Touch the desired operation: [Clear], [Import] or [Export].

Follow the onscreen instructions. To cancel the operation at this point, simply touch an empty area of the display.

#### 2 Touch the desired memory number, and then execute the action selected in the step 1 as below.

Clear	A Confirmation message appears. Touch [Yes] to execute clear.
Import	The File Selection display is called up. Touch the desired file to import, and then touch  or press the [EXIT] button to return.
Export	The File Selection display is called up to export. Touch [Export] on the display, enter the file name, and then touch [OK]. The file name is entered automatically, but you can rename it when saving.

#### 3 As necessary, touch (Save) to save the edited Chord Looper Bank as a new file.

#### NOTICE

If you select a Chord Looper Bank file before saving the edited data, the data will be lost.

## Creating/Editing Styles (Style Creator)

The Style Creator function lets you create your original Style by recording the rhythm pattern via the keyboard and using already-recorded Style data. Basically, select a preset Style that is closest to the type you want to create, then record the rhythm pattern, bass line, chord backing, or phrase (referred to as “Source Pattern” in the Style Creator) for each channel of each Section.

### Style Data Structure—Consisting of Source Patterns

A Style is made up of different Sections (Intro, Main, Ending, etc.) and each Section has eight separate channels, each of which is referred to as a “Source Pattern.” With the Style Creator feature, you can create a Style by separately recording the Source Pattern for each channel, or by importing pattern data from other existing Styles.

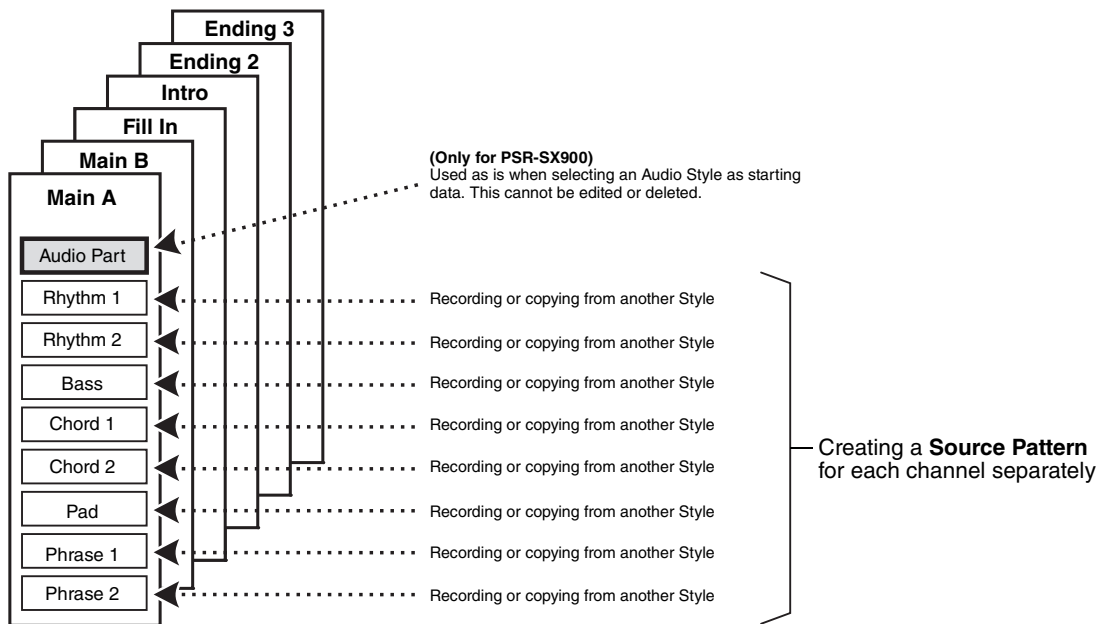

#### (PSR-SX900) Limitations on the Audio part:

- If you select an Audio Style as starting data, the Audio part will be used as is. The Audio part cannot be deleted, edited or created from scratch.
- The created Style containing the Audio part can be used only via an instrument that supports Audio Styles as well as the SFF GE format.
- The Audio part cannot be copied from another Style or Section in the “Assembly” display (page 24). If you want to use a specific Audio part, make sure to select the corresponding Audio Style before calling up the Style Creator display.

## Basic Procedure for Creating a Style

- 1** Select the desired Style to be used as the basis for the new Style.
- 2** Call up the Style Creator display via [MENU] → [Style Creator].
- 3** On the “Basic” display, select the desired Section.

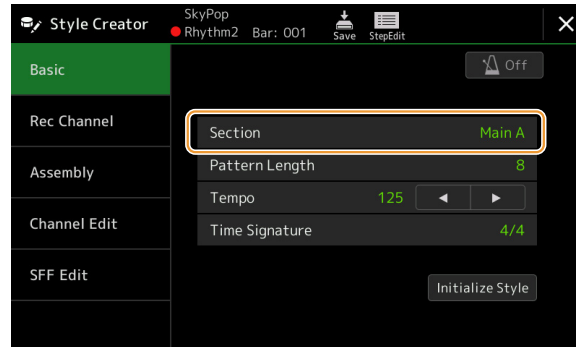

### NOTE

You can also select the Section by pressing one of the corresponding STYLE CONTROL buttons on the panel.

### As necessary, make the following settings.

- If you want to create a Style entirely from scratch, touch [Initialize Style] to make the current Style empty.
- If you initialize the Style, set the “Pattern Length” (measure amount of the Source Pattern). After inputting the value, touch [Execute] to actually enter the changes.

### NOTE

(PSR-SX900) If an Audio Style is selected as starting data, changing the pattern length deletes the corresponding Audio part.

- Set the overall parameters such as “Tempo” and “Time Signature.” The settings here commonly applies to all Sections. After setting the Time Signature, touch [Execute] to actually enter the changes.

## **4** Create the Source Pattern for each channel.

- **Realtime Recording (page 20)**  
Lets you record the Style by simply playing the keyboard.
- **Step Recording (page 23)**  
Lets you enter each note individually.
- **Style Assembly (page 24)**  
Lets you copy various patterns from other preset Styles or Styles you have already created.

## **5** Edit the already recorded channel data.

- **Channel Edit (page 24)**  
Lets you edit the MIDI data of the already recorded channels.
- **SFF Edit (page 26)**  
Lets you edit the SFF (Style File Format) related parameters of already recorded channels other than Rhythm channels.
- **Drum Setup (page 30)**  
Lets you edit the rhythm part of the Style, such as changing the sounds of the individual instruments.

## **6** Repeat steps 3–5 as desired.

## **7** Touch (Save) to save the created Style.

### **NOTICE**

The created Style will be lost if you change to another Style or turn off the power to the instrument without carrying out the Save operation.

# Realtime Recording

The explanations here apply to step 4 of the Basic Procedure on [page 19](#). In the “Rec Channel” display, you can create the channel data via Realtime Recording.

## Realtime Recording Characteristics in the Style Creator

### • Loop Recording

Style playback repeats the rhythm patterns of several measures in a “loop,” and Style recording is also done using loops. For example, if you start recording with a two-measure Main section, the two measures are repeatedly recorded. Notes that you record will play back from the next repetition (loop), letting you record while hearing previously recorded material.

### • Overdub Recording

This method records new material to a channel already containing recorded data, without deleting the original data. In Style recording, the recorded data is not deleted, except when using functions such as “Clear Drum Inst” ([page 21](#)) “Delete” ([pages 21, 23](#)) and “Remove Event” ([page 25](#)). For example, if you start recording with a two-measure Main section, the two measures are repeated many times. Notes that you record will play back from the next repetition, letting you overdub new material to the loop while hearing previously recorded material. When creating a Style based on an existing internal Style, overdub recording is applied only to the rhythm channels. For all other channels (except rhythm), you need to delete the original data before recording.

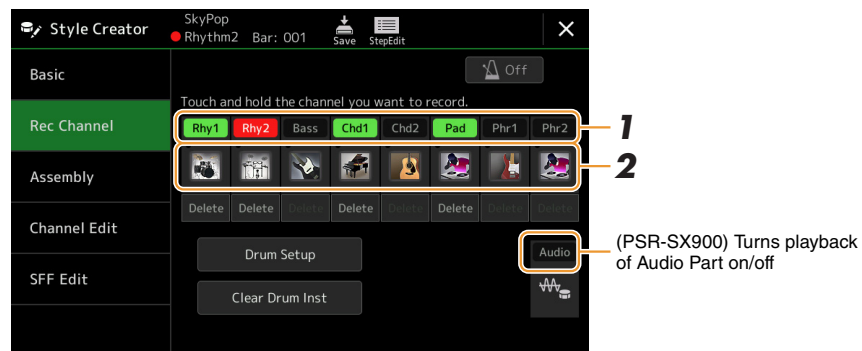

## ■ Recording Rhythm Channels 1–2

### (PSR-SX900) If you select an Audio Style as starting data:

Playback of the Audio part can be turned on or off, but it cannot be edited or deleted. Note that the rhythm pattern of this part will be used in the new Style you intend to create. If you want to create a rhythm phrase in addition to the Audio part, follow the steps below.

### 1 On the “Rec Channel” display, touch and hold the desired channel until it turns red.

The selected channel becomes the Recording target no matter whether the channel already contains data or not. If recorded data is already included, you should record the additional notes to the selected channel as Overdub Recording.



### 2 If necessary, select a Voice, and then practice the rhythm pattern to be recorded.

Touch the instrument icon (illustration) to call up the Voice Selection display then select the desired Voice such as a Drum Kit. After selecting, close the Voice Selection display to return to the Style Creator display. With the selected Voice, practice the rhythm pattern to be recorded.





### Available Voices for recording

For the Rhythm 1 channel, any except Organ Flutes Voices can be used for recording.  
For the Rhythm 2 channel, only Drum/SFX kits can be used for recording.

#### NOTE

For information on which key to play for each Drum/SFX sound, refer to the "Drum/SFX Kit List" in the Data List on the website.

### 3 Press the STYLE CONTROL [START/STOP] button to start recording.

Since already recorded data plays back, turn each channel on or off by touching the channel on the "Rec Channel" display as desired.

If necessary, delete a channel by touching [Delete] located under the desired channel.

#### NOTE

(PSR-SX900) If you selected an Audio Style as starting data, turn the Audio part on or off by touching the [Audio] channel.

### 4 As soon as loop playback returns to the first beat in the first measure, start playing the rhythm pattern to be recorded.

If the rhythm is difficult to play all at once, you can break it down into isolated parts, such as in this example:

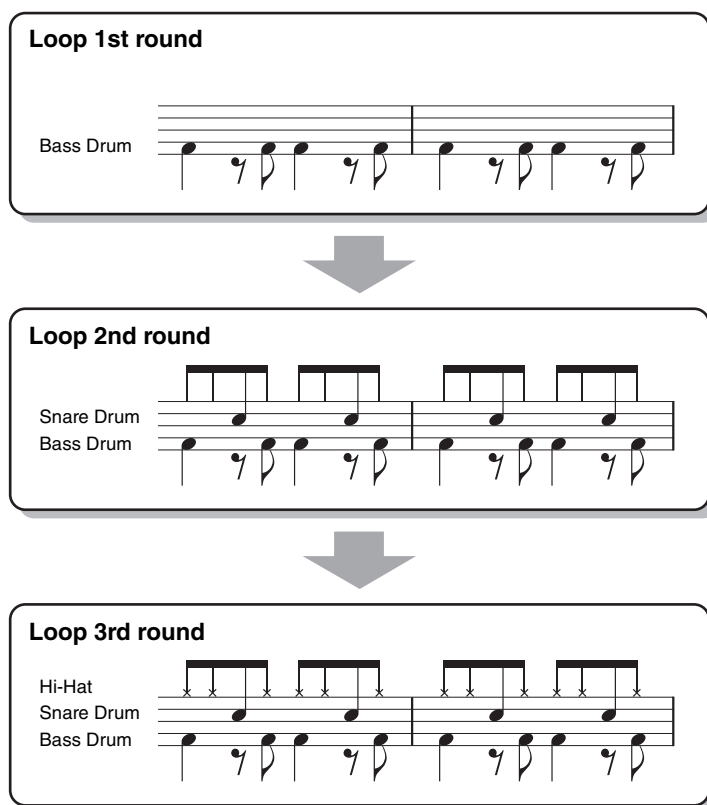

**Loop 1st round**

Bass Drum

**Loop 2nd round**

Snare Drum  
Bass Drum

**Loop 3rd round**

Hi-Hat  
Snare Drum  
Bass Drum

#### Deleting mistakenly recorded notes

If you make a mistake or play any wrong notes, you can delete those specific notes. Touch [Clear Drum Inst] to call up a message, then press the corresponding key on the keyboard while the message is shown. After deleting the desired drum instrument, touch [Exit] to close the message.

### 5 Press the [START/STOP] button to stop playback.

If you want to add more notes, press the [START/STOP] button again to continue recording.

### 6 Touch and hold the Recording channel for a while (until the button changes color) to exit from the Recording mode.

#### **NOTICE**

The edited Style will be lost if you change to another Style or turn off the power to the instrument without carrying out the Save operation (step 7 on page 19).

## ■ Recording Bass, Chord 1–2, Pad and Phrase 1–2

### 1 On the “Rec Channel” display, touch and hold the desired channel until it turns red.

If the selected channel already contains data, a confirmation message appears, prompting you whether or not to delete the existing data of the selected channel. Touch [Yes] to delete data and the selected channel is specified as Record target. Note that channel data other than the Rhythm channels of the preset Style cannot be overdubbed.

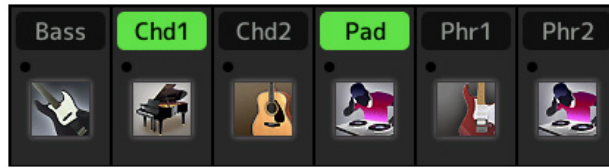

### 2 If necessary, select a Voice, and then practice the bass line, chord backing, or phrase to be recorded.

Touch the instrument icon (illustration) to call up the Voice Selection display then select the desired Voice. After selecting, close the Voice Selection display to return to the Style Creator display. With the selected Voice, practice the phrase or chord backing to be recorded.

#### Available Voices for recording

Any Voices except for the Organ Flutes/Drum kit/SFX kit Voices can be used for recording.

- **Record a phrase in the key of C major (CM7) which will play appropriate notes as you change chords during performance**

#### Rules when recording a Main or Fill-in

With the default initial settings, the Source Root/Chord is set to CM7. This means that you should record a Source Pattern which is to be triggered by specifying CM7 during normal performance. Record a bass line, phrase or chord backing which you want to hear when CM7 is specified. Specifically, see the rules below.

- Use only the CM7 scale tones when recording the Bass and Phrase channels (i.e., C, D, E, G, A, and B).
- Use only the chord tones when recording the Chord and Pad channels (i.e., C, E, G, and B).

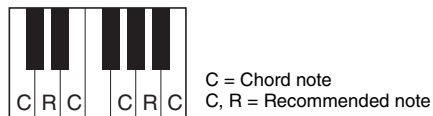

If you observe these rules, Style playback notes are appropriately converted depending on the chord changes you make during your performance.

#### Rules when recording an Intro or Ending

These Sections are designed assuming that the chord is not changed during playback. This is why you need not observe the rules for Main and Fill-In Sections described above, and you can create a special chord progression in recording. However, follow the rules below since the Source Root/Chord is set to CM7 by default.

- When recording the Intro, make sure that the recorded phrase leads properly into a C scale.
- When recording the Ending, make sure that the recorded phrase begins with or properly follows a C scale.

- **Set the Source Root/Chord if necessary**

Although the default Source Root/Chord is set to CM7 as described above, you can change this to any desired one in which you can play easily. Call up the “SFF Edit” display, set the Source Root and Chord to the favorite or desired Root and Chord type. Keep in mind that when you change the Source Chord from the default CM7 to another chord, the chord notes and recommended notes will also change. For details, refer to [page 27](#).



### 3 Press the STYLE CONTROL [START/STOP] button to start recording.

With the already recorded data playing back, turn each channel on or off by touching the channel in the “Rec Channel” display as desired.

If necessary, delete a channel by touching [Delete] located under the desired channel.

#### NOTE

(PSR-SX900) If you selected an Audio Style as starting data, turn the Audio part on or off by touching the [Audio] channel.

### 4 As soon as loop playback returns to the first beat in the first measure, start playing the bass line, chord backing or phrase to be recorded.

### 5 Press the [START/STOP] button to stop playback.

If you want to add more notes, press the [START/STOP] button again to continue recording.

- **To hear the playback sound of the already recorded channels with another Source Chord/Root:**

- 1) Call up the “SFF Edit” display, then set the “Target Ch” at the top of the display to “Rhythm1” or “Rhythm2.”
- 2) Press the STYLE CONTROL [START/STOP] button to start playback.
- 3) Touch [Play Root/Chord] to call up the operation display.
- 4) On the display, set the “Play Root/Chord” to the desired Chord root and Chord type.

This operation lets you hear how the Source Pattern is played back via chord changes during normal performance.

### 6 Touch and hold the Recording channel for a while (until the button changes color) to exit from the Recording mode.

#### **NOTICE**

The edited Style will be lost if you change to another Style or turn off the power to the instrument without carrying out the Save operation (step 7 on page 19).

## Step Recording

The explanations here apply to step 4 of the Basic Procedure on page 19. In the Step Recording (Step Edit) display called up by touching  (Step Edit) at the top of the display, you can record or edit notes one by one. This Step Recording procedure is essentially the same as that for MIDI Song Multi Recording (page 77) with the exception of the points listed below:

- In Song recording, the “End” mark position can be changed freely; in the Style Creator, it cannot be changed. This is because the length of the Style is fixed for all channels as set in the “Basic” display (page 19). For example, if you create a Style of four measures length, the “End” mark position is automatically set to the end of fourth measure, and cannot be changed in the Style Edit display.
- Recording channels can be changed in the Song recording’s Edit display; however, they cannot be changed in the Style Creator. Select the Recording channel in the “Rec channel” display.
- In the Style Creator, Chord, Lyrics, and System Exclusive data cannot be entered. The Channel data can be entered and System Exclusive data can be edited (delete, copy or move).

#### NOTE

(PSR-SX900) If you select an Audio Style as starting data, the Audio part will be used as is. The Audio part cannot be deleted, edited or created from scratch.

## Assembly—Assigning the Source Pattern to Each Channel

The explanations here apply to step 4 of the Basic Procedure on [page 19](#). The “Assembly” display shows each channel data of the current Section, and where it has been copied from (Style, Section, and channel). For each channel, touch the Style name, Section name, or Channel name as necessary to select the desired item.

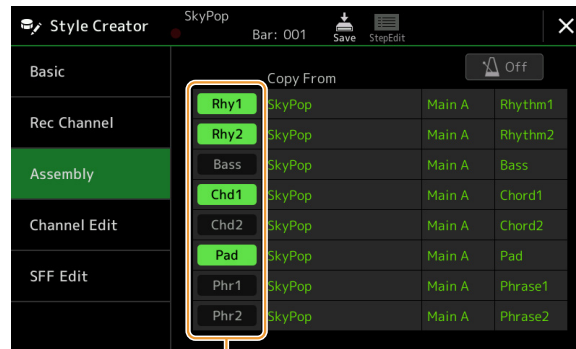

Channels with data are displayed as “On” (in green). Turning on/off here, you can select whether each channel is played or not during audition playback.

### NOTE

- (PSR-SX900) An Audio part cannot be copied from another Style. If you want to use a specific Audio part, make sure to select the corresponding Audio Style before calling up the Style Creator display.
- (PSR-SX900) If you select an Audio Style as starting data, the Audio part cannot be replaced with different data.

### NOTICE

The edited Style will be lost if you change to another Style or turn off the power to the instrument without carrying out the Save operation (step 7 on [page 19](#)).

## Channel Edit

The explanations here apply to step 5 of the Basic Procedure on [page 19](#). The “Channel Edit” display lets you edit already recorded channel data. Select the Target channel and then edit the desired parameters.

After editing the desired parameter, touch [Execute] to actually enter the edits for each setup window. When execution is completed, this button changes to [Undo], letting you restore the original data if you are not satisfied with the results. The Undo function only has one level; only the previous operation can be undone.

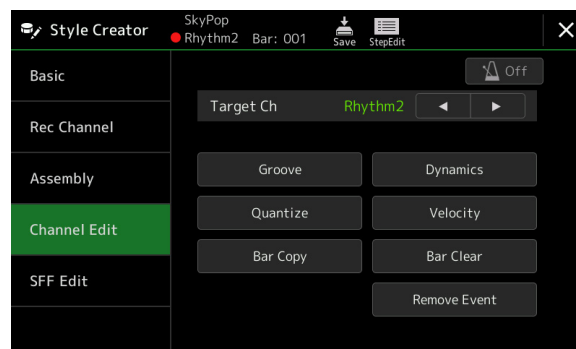

### NOTE

(PSR-SX900) If you select an Audio Style as starting data, the Audio part will be used as is. The Audio part cannot be deleted, edited or created from scratch.

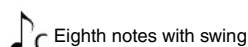
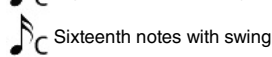
Target Ch	Select the target channel to be edited. All items with the exception of “Groove” are to be applied to the channel specified here.	
Groove	This lets you add swing to the music or change the “feel” of the beat by making subtle shifts in the timing (clock) of the Style. The Groove settings are applied to all channels of the selected Section.	
	Original Beat	Specifies the beats to which Groove timing is to be applied. In other words, if “8 Beat” is selected, Groove timing is applied to the 8th notes; if “12 Beat” is selected, Groove timing is applied to 8th-note triplets.
	Beat Converter	Actually changes the timing of the beats (specified in the “Original Beat” parameter above) to the selected value. For example, when Original Beat is set to “8 Beat” and Beat Converter is set to “12,” all 8th notes in the section are shifted to 8th-note triplet timing. The “16A” and “16B” Beat Converter which appear when Original Beat is set to “12 Beat” are variations on a basic 16th-note setting.
	Swing	Produces a “swing” feel by shifting the timing of the back beats, depending on the “Original Beat” parameter above. For example, if the specified Original Beat value is “8 Beat”, the Swing parameter will selectively delay the 2nd, 4th, 6th, and 8th beats of each measure to create a swing feel. The settings “A” through “E” produce different degrees of swing, with “A” being the most subtle and “E” being the most pronounced.
	Fine	Selects a variety of Groove “templates” to be applied to the selected section. The “Push” settings cause certain beats to be played early, while “Heavy” settings delay the timing of certain beats. The numbered settings (2, 3, 4, 5) determine which beats are to be affected. All beats up to the specified beat—but not including the first beat—will be played early or delayed (for example, the 2nd and 3rd beats, if “3” is selected). In all cases, “A” types produce minimum effect, “B” types produce medium effect, and “C” types produce maximum effect.
Dynamics	This changes the velocity/volume (or accent) of certain notes in the Style playback. The Dynamics settings can be applied to each channel individually or all channels of the selected Style.	
	Accent Type	Determines the type of accent applied—in other words, which notes are emphasized.
	Strength	Determines how strongly the selected Accent Type (above) will be applied. The higher the value, the stronger the effect
	Expand/Compress	Expands or compresses the range of velocity values. Values higher than 100% expand the dynamic range, while values lower than 100% compress it.
	Boost/Cut	Boosts or cuts all velocity values. Values above 100% boost the overall velocity, while values below 100% reduce it.
	Apply To All Channels	When set to “On,” the settings in this display will be applied to all the channels of the current Section. When set to “Off,” the settings in this display will be applied to the channel specified at the “Target Ch” in the “Channel Edit” display.
Quantize	Same as in MIDI Multi Recording ( <a href="#">page 75</a> ), with the exception of the two additional available parameters below.   Eighth notes with swing  Sixteenth notes with swing	
Velocity	Boosts or cuts the velocity of all notes in the specified channel, according to the percentage specified here.	
Bar Copy	This function allows data to be copied from one measure or group of measures to another location within the specified channel.	
	Source Top	Specifies the first (Source Top) and last (Source Last) measures in the region to be copied.
	Source Last	
	Destination	Specifies the first measure of the destination location, to which the data is to be copied.
Bar Clear	This function clears all data from the specified range of measures within the selected channel.	
Remove Event	This function lets you remove specific events from the selected channel.	

**NOTICE**

The edited Style will be lost if you change to another Style or turn off the power to the instrument without carrying out the Save operation (step 7 on [page 19](#)).

## SFF Edit—Making Style File Format Settings

The explanations here apply to step 5 of the Basic Procedure on [page 19](#). The Style File Format (SFF) combines all of Yamaha’s Style playback know-how into a single unified format. Setting the SFF related parameters determines how the original notes are converted to the actual sounded notes based on the chord you specify in the Chord area of the keyboard. The conversion flow is shown below.

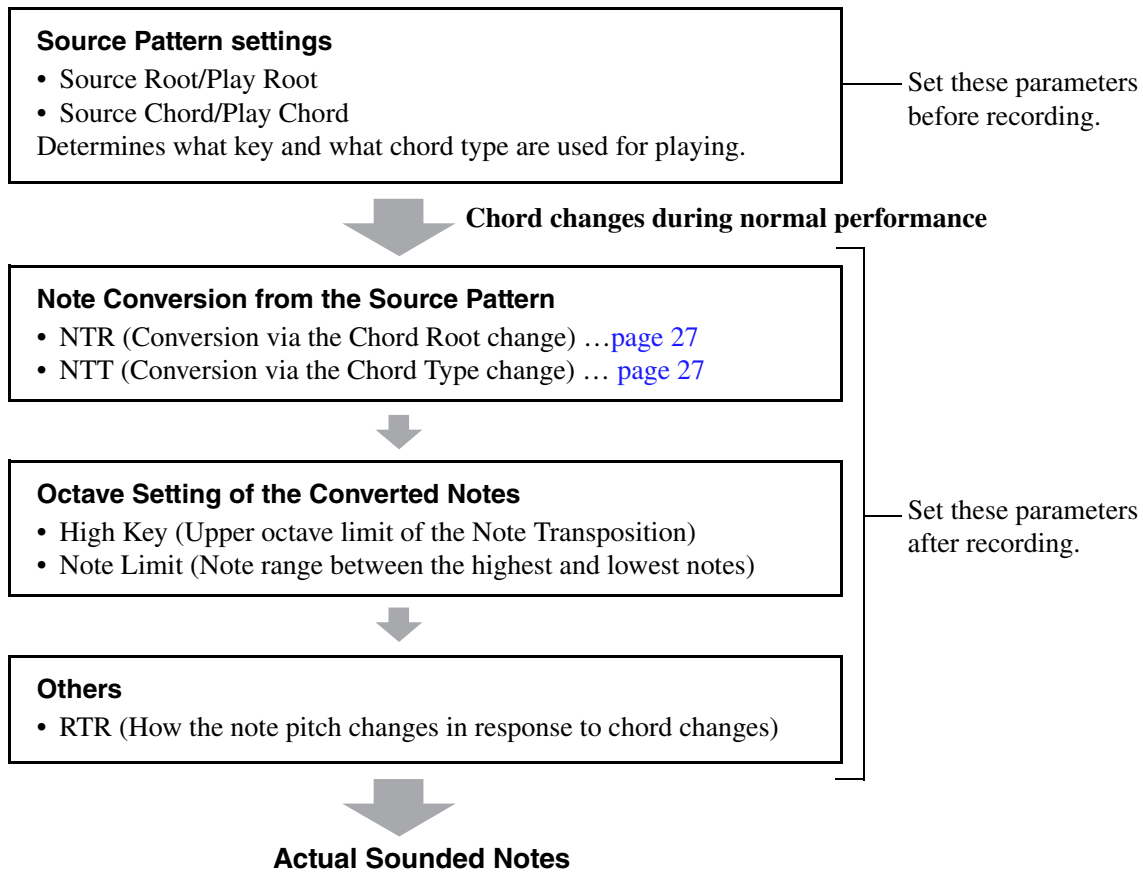



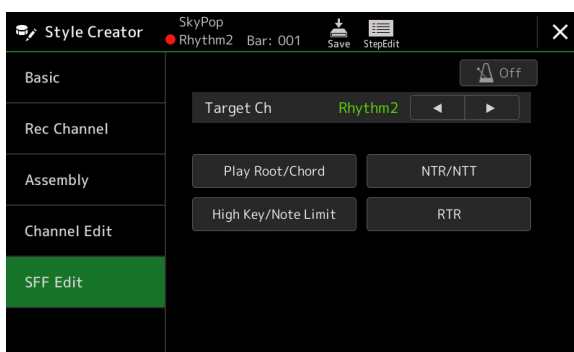





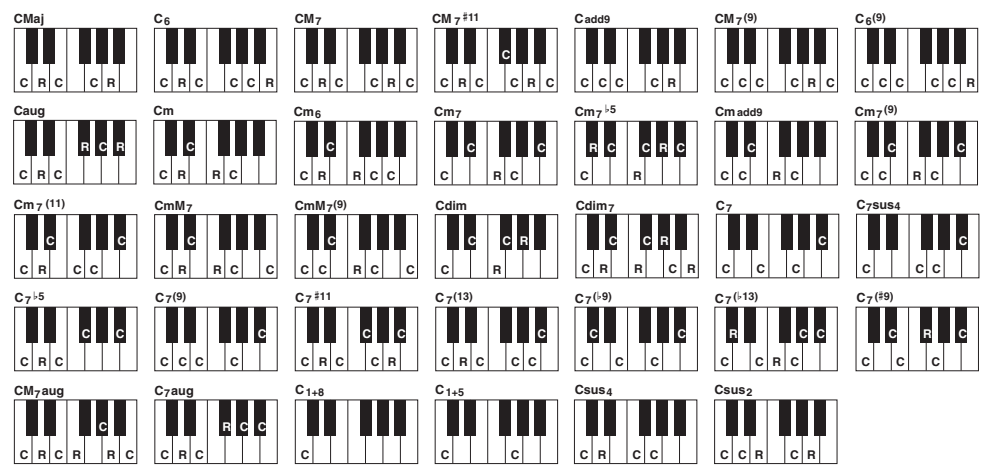



The parameters shown above can be set in the “SFF Edit” display.



### NOTE

(PSR-SX900) If you select an Audio Style as starting data, the Audio part will be used as is. The Audio part cannot be deleted, edited or created from scratch.

Target Ch	Determines the target channel to be edited.															
Source Root/ Chord (Play Root/ Chord)	<p>These settings determine the original key of the Source Pattern (i.e., the key used when recording the pattern to a channel other than the Rhythm channels). If you set “Fm7” here, specifying “Fm7” in the Chord section of the keyboard will play back the originally recorded data (Source Pattern). The default setting is “CM7” (Source Root = C and Source Chord = M7). Depending on the selected chord type specified here, the playable notes (scale notes and chord notes) differ. When “Initialize Style” is executed in the “Basic” display, the default setting of CM7 is automatically selected.</p> <p><b>Playable notes when Source Root is C:</b></p>  <p>C = Chord notes C, R = Recommended notes</p> <p><b>IMPORTANT</b> Make sure to set the parameters here before recording. If you change the settings after recording, the recorded Source Pattern cannot be converted to the appropriate notes when changing the chord during your keyboard performance.</p> <p><b>NOTE</b> When the parameters for the selected Target Ch are set to NTR: Root Fixed, NTT Type: Bypass, or NTT Bass: Off, the parameters here are changed to “Play Root” and “Play Chord,” respectively. In this case, you can change chords and hear the resulting sound for all channels.</p> <p><b>NOTE</b> The settings here are not applied when NTR is set to “Guitar.”</p>															
NTR/NTT (Note Transposition Rule/ Note Transposition Table)	<p>The parameters here determine how the notes in the Source Pattern are converted according to the chord changes during your keyboard performance.</p> <table border="1"> <tr> <td data-bbox="347 1384 491 1870">NTR</td> <td data-bbox="491 1384 1455 1870"> <p>Selects the Note Transposition Rule which determines how the notes in the Source Pattern are transposed according to the Chord Root change.</p> <table border="1"> <tr> <td data-bbox="491 1462 635 1630">Root Trans</td> <td data-bbox="635 1462 1173 1630"> <p>When the root note is transposed, the interval between notes is maintained. For example, the notes C3, E3 and G3 in the key of C become F3, A3 and C4 when they are transposed to F. Use this setting for channels that contain melody lines.</p> </td> <td data-bbox="1173 1462 1455 1630">  <p>When playing a C major chord. → When playing an F major chord.</p> </td> </tr> <tr> <td data-bbox="491 1630 635 1798">Root Fixed</td> <td data-bbox="635 1630 1173 1798"> <p>The note is kept as close as possible to the previous note range. For example, the notes C3, E3 and G3 in the key of C become C3, F3 and A3 when they are transposed to F. Use this setting for channels that contain chord parts.</p> </td> <td data-bbox="1173 1630 1455 1798">  <p>When playing a C major chord. → When playing an F major chord.</p> </td> </tr> <tr> <td data-bbox="491 1798 635 1870">Guitar</td> <td colspan="2" data-bbox="635 1798 1455 1870"> <p>This is exclusively for transposing guitar accompaniment. Notes are transposed to approximate the chords played with natural guitar fingering.</p> </td> </tr> </table> </td> </tr> <tr> <td data-bbox="347 1870 491 2094">NTT Type</td> <td data-bbox="491 1870 1455 2094"> <p>Selects the Note Transposition Table which determines how the notes in the Source Pattern are transposed according to the Chord Type change.</p> <p><b>● When NTR is set to “Root Trans” or “Root Fixed”:</b></p> <table border="1"> <tr> <td data-bbox="491 2000 635 2094">Bypass</td> <td data-bbox="635 2000 1455 2094"> <p>When NTR is set to Root Fixed, the transposition table used does not do any note conversion. When NTR is set to Root Trans, the table used only converts the notes by maintaining the pitch relationship between notes.</p> </td> </tr> </table> </td> </tr> </table>	NTR	<p>Selects the Note Transposition Rule which determines how the notes in the Source Pattern are transposed according to the Chord Root change.</p> <table border="1"> <tr> <td data-bbox="491 1462 635 1630">Root Trans</td> <td data-bbox="635 1462 1173 1630"> <p>When the root note is transposed, the interval between notes is maintained. For example, the notes C3, E3 and G3 in the key of C become F3, A3 and C4 when they are transposed to F. Use this setting for channels that contain melody lines.</p> </td> <td data-bbox="1173 1462 1455 1630">  <p>When playing a C major chord. → When playing an F major chord.</p> </td> </tr> <tr> <td data-bbox="491 1630 635 1798">Root Fixed</td> <td data-bbox="635 1630 1173 1798"> <p>The note is kept as close as possible to the previous note range. For example, the notes C3, E3 and G3 in the key of C become C3, F3 and A3 when they are transposed to F. Use this setting for channels that contain chord parts.</p> </td> <td data-bbox="1173 1630 1455 1798">  <p>When playing a C major chord. → When playing an F major chord.</p> </td> </tr> <tr> <td data-bbox="491 1798 635 1870">Guitar</td> <td colspan="2" data-bbox="635 1798 1455 1870"> <p>This is exclusively for transposing guitar accompaniment. Notes are transposed to approximate the chords played with natural guitar fingering.</p> </td> </tr> </table>	Root Trans	<p>When the root note is transposed, the interval between notes is maintained. For example, the notes C3, E3 and G3 in the key of C become F3, A3 and C4 when they are transposed to F. Use this setting for channels that contain melody lines.</p>	 <p>When playing a C major chord. → When playing an F major chord.</p>	Root Fixed	<p>The note is kept as close as possible to the previous note range. For example, the notes C3, E3 and G3 in the key of C become C3, F3 and A3 when they are transposed to F. Use this setting for channels that contain chord parts.</p>	 <p>When playing a C major chord. → When playing an F major chord.</p>	Guitar	<p>This is exclusively for transposing guitar accompaniment. Notes are transposed to approximate the chords played with natural guitar fingering.</p>		NTT Type	<p>Selects the Note Transposition Table which determines how the notes in the Source Pattern are transposed according to the Chord Type change.</p> <p><b>● When NTR is set to “Root Trans” or “Root Fixed”:</b></p> <table border="1"> <tr> <td data-bbox="491 2000 635 2094">Bypass</td> <td data-bbox="635 2000 1455 2094"> <p>When NTR is set to Root Fixed, the transposition table used does not do any note conversion. When NTR is set to Root Trans, the table used only converts the notes by maintaining the pitch relationship between notes.</p> </td> </tr> </table>	Bypass	<p>When NTR is set to Root Fixed, the transposition table used does not do any note conversion. When NTR is set to Root Trans, the table used only converts the notes by maintaining the pitch relationship between notes.</p>
NTR	<p>Selects the Note Transposition Rule which determines how the notes in the Source Pattern are transposed according to the Chord Root change.</p> <table border="1"> <tr> <td data-bbox="491 1462 635 1630">Root Trans</td> <td data-bbox="635 1462 1173 1630"> <p>When the root note is transposed, the interval between notes is maintained. For example, the notes C3, E3 and G3 in the key of C become F3, A3 and C4 when they are transposed to F. Use this setting for channels that contain melody lines.</p> </td> <td data-bbox="1173 1462 1455 1630">  <p>When playing a C major chord. → When playing an F major chord.</p> </td> </tr> <tr> <td data-bbox="491 1630 635 1798">Root Fixed</td> <td data-bbox="635 1630 1173 1798"> <p>The note is kept as close as possible to the previous note range. For example, the notes C3, E3 and G3 in the key of C become C3, F3 and A3 when they are transposed to F. Use this setting for channels that contain chord parts.</p> </td> <td data-bbox="1173 1630 1455 1798">  <p>When playing a C major chord. → When playing an F major chord.</p> </td> </tr> <tr> <td data-bbox="491 1798 635 1870">Guitar</td> <td colspan="2" data-bbox="635 1798 1455 1870"> <p>This is exclusively for transposing guitar accompaniment. Notes are transposed to approximate the chords played with natural guitar fingering.</p> </td> </tr> </table>	Root Trans	<p>When the root note is transposed, the interval between notes is maintained. For example, the notes C3, E3 and G3 in the key of C become F3, A3 and C4 when they are transposed to F. Use this setting for channels that contain melody lines.</p>	 <p>When playing a C major chord. → When playing an F major chord.</p>	Root Fixed	<p>The note is kept as close as possible to the previous note range. For example, the notes C3, E3 and G3 in the key of C become C3, F3 and A3 when they are transposed to F. Use this setting for channels that contain chord parts.</p>	 <p>When playing a C major chord. → When playing an F major chord.</p>	Guitar	<p>This is exclusively for transposing guitar accompaniment. Notes are transposed to approximate the chords played with natural guitar fingering.</p>							
Root Trans	<p>When the root note is transposed, the interval between notes is maintained. For example, the notes C3, E3 and G3 in the key of C become F3, A3 and C4 when they are transposed to F. Use this setting for channels that contain melody lines.</p>	 <p>When playing a C major chord. → When playing an F major chord.</p>														
Root Fixed	<p>The note is kept as close as possible to the previous note range. For example, the notes C3, E3 and G3 in the key of C become C3, F3 and A3 when they are transposed to F. Use this setting for channels that contain chord parts.</p>	 <p>When playing a C major chord. → When playing an F major chord.</p>														
Guitar	<p>This is exclusively for transposing guitar accompaniment. Notes are transposed to approximate the chords played with natural guitar fingering.</p>															
NTT Type	<p>Selects the Note Transposition Table which determines how the notes in the Source Pattern are transposed according to the Chord Type change.</p> <p><b>● When NTR is set to “Root Trans” or “Root Fixed”:</b></p> <table border="1"> <tr> <td data-bbox="491 2000 635 2094">Bypass</td> <td data-bbox="635 2000 1455 2094"> <p>When NTR is set to Root Fixed, the transposition table used does not do any note conversion. When NTR is set to Root Trans, the table used only converts the notes by maintaining the pitch relationship between notes.</p> </td> </tr> </table>	Bypass	<p>When NTR is set to Root Fixed, the transposition table used does not do any note conversion. When NTR is set to Root Trans, the table used only converts the notes by maintaining the pitch relationship between notes.</p>													
Bypass	<p>When NTR is set to Root Fixed, the transposition table used does not do any note conversion. When NTR is set to Root Trans, the table used only converts the notes by maintaining the pitch relationship between notes.</p>															

NTR/NTT (Note Transposition Rule/ Note Transposition Table)	NTT Type	Melody	Suitable for melody line transposition. Use this for melody channels such as “Phrase1” and “Phrase2.”	
		Chord	Suitable for chordal parts transposition. Use this for the “Chord1” and “Chord2” channels, especially when they contain piano or guitar-like chordal parts.	
		Melodic Minor	When the played chord changes from a major to a minor chord, this table lowers the third interval in the scale by a semitone. When the chord changes from a minor to a major chord, the minor third interval is raised by a semitone. Other notes are not changed. Use this for melody channels of Sections which respond only to major/minor chords, such as Intros and Endings.	
		Melodic Minor 5th	In addition to the Melodic Minor transposition above, augmented and diminished chords affect the 5th note of the Source Pattern.	
		Harmonic Minor	When the played chord changes from a major to a minor chord, this table lowers the third and sixth intervals in the scale by a semitone. When the chord changes from a minor to a major chord, the minor third and flatted sixth intervals are raised by a semitone. Other notes are not changed. Use this for chord channels of Sections which respond only to major/minor chords, such as Intros and Endings.	
		Harmonic Minor 5th	In addition to the Harmonic Minor transposition above, augmented and diminished chords affect the 5th note of the Source pattern.	
		Natural Minor	When the played chord changes from a major to a minor chord, this table lowers the third, sixth and seventh intervals in the scale by a semitone. When the chord changes from a minor to a major chord, the minor third, flatted sixth and flatted seventh intervals are raised by a semitone. Other notes are not changed. Use this for chord channels of Sections which respond only to a major/minor chord such as Intros and Endings.	
		Natural Minor 5th	In addition to the Natural Minor transposition above, augmented and diminished chords affect the 5th note of the Source pattern.	
		Dorian	When the played chord changes from a major to a minor chord, this table lowers the third and seventh intervals in the scale by a semitone. When the chord changes from a minor to a major chord, the minor third and flatted seventh intervals are raised by a semitone. Other notes are not changed. Use this for chord channels of Sections which respond only to a major/minor chord such as Intros and Endings.	
		Dorian 5th	In addition to the Dorian transposition above, augmented and diminished chords affect the 5th note of the Source pattern.	
		<b>● When NTR is set to “Guitar”:</b>		
		All Purpose	This table covers both strummed and arpeggio-played sounds.	
		Stroke	Suitable for strumming sounds of the guitar. Some notes may sound as if they are muted—this is the normal condition when chords are played on guitar by strumming.	
	Arpeggio	Suitable for arpeggio-played sound of the guitar, resulting in beautiful four-note arpeggio sounds.		
NTT Bass	The channel for which this is set to “On” will be played back by the bass root note, when the on-bass chord is recognized by the instrument. When NTR is set to Guitar and this parameter is set to “On,” only the note which is assigned to bass will be played back by the bass root note.			
<b>NTR/NTT Settings for the Rhythm Channels</b> Since the Rhythm channels should not be affected by Chord change, make sure to make the following settings. <ul style="list-style-type: none"> <li>• NTR = Root Fixed</li> <li>• NTT = Bypass</li> <li>• NTT Bass = Off</li> </ul> With the above settings, the “Source Root” and “Source Chord” parameters are changed to “Play Root” and “Play Chord,” respectively.				



High Key/Note Limit	Adjusts the Octave of the notes converted via the NTT and NTR.	
	High Key	<p>This sets the highest key (upper octave limit) of the note transposition for the chord root change. Any notes calculated to be higher than the highest key are transposed down to the next lowest octave. This setting is available only when the NTR parameter (page 27) is set to “Root Trans.”</p> <p><b>Example—When the highest key is F</b></p> <p>Root changes → CM      C#M      . . .      FM      F#M      . . .</p> <p>Notes played → C3-E3-G3      C#3-E#3-G#3      F3-A3-C4      F#2-A#2-C#3</p>
Note Limit Low	<p>These set the note range (highest and lowest notes) for Voices recorded to the Style channels. By judicious setting of this range, you can ensure that the Voices sound as realistic as possible—in other words, that no notes outside the natural range are sounded (e.g., high bass sounds or low piccolo sounds).</p> <p><b>Example—When the lowest note is C3 and the highest is D4</b></p> <p>Root changes → CM      C#M      . . .      FM      . . .</p> <p>Notes played → E3-G3-C4      E#3-G#3-C#4      F3-A3-C4</p>	
Note Limit High		
RTR (Retrigger Rule)	These settings determine whether notes stop sounding or not and how they change pitch in response to chord changes.	
	Stop	The notes stop sounding.
	Pitch Shift	The pitch of the note will bend without a new attack to match the type of the new chord.
	Pitch Shift to Root	The pitch of the note will bend without a new attack to match the root of the new chord. However, the octave of the new note remains the same.
	Retrigger	The note is retriggered with a new attack at a new pitch corresponding to the next chord.
	Retrigger To Root	The note is retriggered with a new attack at the root note of the next chord. However, the octave of the new note remains the same.

**NOTICE**  
The edited Style will be lost if you change to another Style or turn off the power to the instrument without carrying out the Save operation (step 7 on page 19).

## Editing the Rhythm Part of a Style (Drum Setup)

The explanations here apply to step 5 of the Basic Procedure on [page 19](#). The Rhythm parts of a preset Style consist of a preset Drum Kit, and each drum sound is assigned to a separate note. You may want to change the sound and the note assignments, or make more detailed settings such as volume balance, effect, etc. By using the Drum Setup function of the Style Creator, you can edit the Rhythm part of a Style and save it as an original Style.

- 1 On the “Rec Channel” display, touch and hold the desired Rhythm channel until it turns red.

### NOTE

If the different drum sounds are assigned to each section of the selected channel, the sounds are set to that of the current section in order to use the Drum Setup function.



- 2 Touch [Drum Setup] to call up the “Drum Setup” window.
- 3 If necessary, press the STYLE CONTROL [START/STOP] button to start playback of the rhythm part.

The sounds played back are indicated on the display keyboard, making it easy to find the note for editing.

- 4 Select the note to be edited by touching the display.

### NOTE

You can also select the note by pressing the note on the keyboard.

- 5 Select the desired Kit, Category and Instrument (in that order).

- 6 If necessary, make detailed settings.

Level	For adjusting the volume level.
Pan	Determines the stereo position.
Pitch	For fine tuning of the pitch in cent increments.  NOTE In musical terms a “cent” is 1/100th of a semitone. (100 cents equal one semitone.)
Cutoff	Determines the cutoff frequency or effective frequency range of the filter. Higher values result in a brighter sound.
Resonance	Determines the emphasis given to the cutoff frequency (resonance), set in Filter Cutoff above. Higher values result in a more pronounced effect.
Attack	Determines how quickly the sound reaches its maximum level after the key is played. The higher the value, the quicker the attack.
Decay 1	Determines how quickly the sound reaches its sustain level (a slightly lower level than maximum). The higher the value, the quicker the decay.
Decay 2	Determines how quickly the sound decays to silence after the key is released. The higher the value, the quicker the decay.

Alt Group	Determines the Alternate Group. Any instruments in the same group number cannot sound at the same time. Playing any instrument within a numbered group will immediately stop the sound of any other instrument in the same group of the same number. If this is set to 0, all instruments in the group can sound at the same time.
Reverb	For adjusting the reverb depth.
Chorus	For adjusting the chorus depth.
Variation	For adjusting the variation effect (DSP1) depth. When the “Connection” parameter is set to “Insertion” on the Mixing Console display and this rhythm channel is selected as the assign part, this parameter functions in the following ways: <ul style="list-style-type: none"> <li>• <b>When Variation Send is set to 0:</b> No effects are applied to the instrument (Insertion Off).</li> <li>• <b>When Variation Send is set to 1–127:</b> Effects are applied to the instrument (Insertion On).</li> </ul>
Rcv Note Off	Determines whether note-off messages are received or not.
Key Assign	Determines the Key Assign mode. This parameter is effective only when the kit’s XG parameter “SAME NOTE NUMBER KEY ON ASSIGN” (see the Data List on the website) is set to “INST.” <ul style="list-style-type: none"> <li>• <b>Single:</b> Each successive playing of the same sound results in the previous being cut off or muted.</li> <li>• <b>Multi:</b> Each sound continues to its full decay, even when played successively multiple times.</li> </ul>

## 7 Press the [EXIT] button to close the “Drum Setup” window.

### NOTICE

The edited Style will be lost if you change to another Style or turn off the power to the instrument without carrying out the Save operation (step 7 on page 19).











## Contents

Voice Part Setup Display .....	32
Voice Selection Display-related Settings .....	34
Voice Types (Characteristics) .....	35
Registering Files to the Favorite Tab .....	36
Metronome Settings .....	36
• Metronome .....	36
• Tap Tempo .....	36
Keyboard/Joystick-related Settings .....	37
• Setting the Touch Response of the Keyboard .....	37
• Making the Joystick Settings .....	38
Keyboard Part-related Settings (Voice Setting) .....	39
• Tune .....	39
• Voice Set Filter .....	39
• Arpeggio .....	39
Transposing the Pitch in Semitones .....	40
Fine Tuning the Pitch of the Entire Instrument (Master Tune) .....	41
Selecting or Creating a Temperament (Scale Tune) .....	41
• Selecting or Creating a Temperament from the Preset Types (Main Scale) .....	42
• Creating and Using a Temperament Temporarily (Sub Scale) .....	43
Making Detailed Settings for Harmony/Arpeggio .....	44
Editing Voices (Voice Edit) .....	46
• Editable Parameters in the Voice Edit display .....	47
Editing Organ Flutes Voices (Voice Edit) .....	50

## Voice Part Setup Display

The Voice Part Setup display is called up by pressing via [MENU] → [Voice Part Setup], and provides easy-to-understand indication of the current settings of each keyboard part, and lets you make important settings for the Voices, including EQ and effects.





①	Voice	<p>Indicates the current Voice and the on/off status of the part. Touching the Voice name calls up the Voice Selection display for the corresponding part. Touching the Part icon turns the part on/off.</p> <p>When an Organ Flutes Voice is selected, you can call up the Voice Edit display (page 50) for the part by touching  (Organ Flutes) shown here.</p> <p>When a Super Articulation (S.Art) Voice is selected, the following icons appear, indicating when the effects are available and how to use them.</p> <ul style="list-style-type: none"> <li> : Move the joystick upward.</li> <li> : Move the joystick horizontally to bend the pitch. When the multiple keys are pressed, only one note's pitch bends.</li> <li> : Press any key repeatedly to switch among the sounds (waveforms).</li> <li> : Play keys in legato fashion.</li> <li> : While holding down one key, press another key and release it to play trills.</li> <li> : Press the key strongly.</li> <li> : Press the key strongly while moving the joystick upward.</li> <li> : Press the foot pedal connected to the FOOT PEDAL [2] jack (*).</li> <li> : Press the key strongly while holding down the foot pedal connected to the FOOT PEDAL [2] jack (*).</li> </ul> <p><small>* The icon is as this because the foot pedal connected to the FOOT PEDAL [2] jack is assigned to "Articulation1" function by default. Using the ASSIGNABLE buttons or [ROTARY SP/ASSIGNABLE] button that the same function is assigned will have the same effect.</small></p>									
②	<table border="1" style="width: 100%; border-collapse: collapse;"> <tr> <td data-bbox="240 831 469 882">Mono/Poly</td> <td data-bbox="469 831 1447 882">Determines whether the Voice is played monophonically or polyphonically.</td> </tr> <tr> <td data-bbox="240 882 469 956">Octave</td> <td data-bbox="469 882 1447 956">Determines the range of the pitch change in octaves, over two octaves up or down for each keyboard part.</td> </tr> <tr> <td data-bbox="240 956 469 1030">EQ</td> <td data-bbox="469 956 1447 1030">Indicates the EQ settings adjusted in the Mixer display (page 103). Touching here calls up the Mixer display.</td> </tr> <tr> <td data-bbox="240 1030 469 1081">Pan</td> <td data-bbox="469 1030 1447 1081" rowspan="2">Adjusts the stereo position (pan), or volume for each part. The settings here are equivalent to those in the Mixer display (page 107).</td> </tr> <tr> <td data-bbox="240 1081 469 1133">Volume</td> </tr> </table>	Mono/Poly	Determines whether the Voice is played monophonically or polyphonically.	Octave	Determines the range of the pitch change in octaves, over two octaves up or down for each keyboard part.	EQ	Indicates the EQ settings adjusted in the Mixer display (page 103). Touching here calls up the Mixer display.	Pan	Adjusts the stereo position (pan), or volume for each part. The settings here are equivalent to those in the Mixer display (page 107).	Volume	
Mono/Poly	Determines whether the Voice is played monophonically or polyphonically.										
Octave	Determines the range of the pitch change in octaves, over two octaves up or down for each keyboard part.										
EQ	Indicates the EQ settings adjusted in the Mixer display (page 103). Touching here calls up the Mixer display.										
Pan	Adjusts the stereo position (pan), or volume for each part. The settings here are equivalent to those in the Mixer display (page 107).										
Volume											
③	Insertion Effect	Indicates the current Insertion Effect type for the part and the on/off status of the effect. Touching "On" or "Off" turns the Insertion Effects on or off. Touching another area here calls up the Insertion Effect setting display (page 106) for the corresponding part.									
④	Effect Depth (Ins/Cho/Rev)	Indicates the depth of the Insertion Effect, Chorus, and Reverb for the part which can be adjusted in the Mixer display (pages 105, 107). Touching here calls up the Effect page of the Mixer display.									

### To store the Voice Part Setup:

If you want to store the settings on the Voice Part Setup display, use the Registration Memory. Press the [MEMORY] button in the REGISTRATION MEMORY section, then checkmark "Voice" and press one of the REGISTRATION MEMORY [1]–[8] buttons to register the Voice settings.

## Voice Selection Display-related Settings

On the pop-up window called up by touching  (Menu) on the Voice Selection display, you can make the following settings.

Category	<p>Determines how the Voice category page is opened when a Voice category is selected.</p> <ul style="list-style-type: none"><li>• <b>Open &amp; Select:</b> Opens the page with the previously selected Voice in the Voice category automatically selected.</li><li>• <b>Open Only:</b> Opens the page with the currently selected Voice.</li></ul>
Voice Number	<p>Determines whether or not the Voice bank and number are shown in the Voice Selection display. This is useful when you want to check which bank select MSB/LSB values and program change number you need to specify when selecting the Voice from an external MIDI device.</p> <p> <b>NOTE</b></p> <p>The numbers displayed here start from "1." Accordingly the actual MIDI program change numbers are one lower, since that number system starts from "0."</p>



 **NOTE**

The [Voice Edit], [Mixer] and [Voice Setting] menus are the same as those in the Menu display called up via the [MENU] button.

## Voice Types (Characteristics)

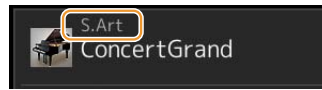
The defining characteristics of the particular Voice type and their performance advantages are described below. To see the type of each Voice, refer to the Voice List in the Data List on the website. Only the types marked by “\*” in the list below are indicated at the upper left of the Voice name in the Voice Selection display.



S.Art (Super Articulation)*	These Voices provide many benefits with great playability and expressive control in real time. For example, with the Saxophone Voice, if you play a C and then a D in a very legato way, you will hear the note change seamlessly, as though a saxophone player played it in a single breath. Similarly with the Concert Guitar Voice, if you play a C note and then the E just above in a very legato but firm way, the pitch slides up from C to E. Depending on how you play, other effects such as “shaking” or breath noises (for the Trumpet Voice), or finger noises (for the Guitar Voice) are produced.
Live	These acoustic instrument sounds were sampled in stereo, to produce a truly authentic, rich sound—full of atmosphere and ambience.
Cool	These Voices use sophisticated programming to capture the dynamic textures and subtle nuances of electric instruments.
Sweet	These acoustic instrument sounds also benefit from Yamaha’s sophisticated technology, and feature a finely detailed and natural sound.
Drums	Various drum and percussion sounds are assigned to individual keys, letting you play the sounds from the keyboard.
SFX	Various special effect sounds and percussion sounds are assigned to individual keys, letting you play the sounds from the keyboard.
Live Drums	These are high-quality drum sounds that take full advantage of Stereo Sampling and Dynamic Sampling.
Live SFX	These are various high-quality special effect sounds and percussion sounds that take full advantage of Stereo Sampling and Dynamic Sampling.
Organ Flutes*	These authentic organ Voices let you adjust the various footages and craft your own original organ sounds. See <a href="#">page 50</a> for details.
MegaVoice*	<p>These Voices make special use of velocity switching. Each velocity range (the measure of your playing strength) has a completely different sound. For example, a guitar MegaVoice includes the sounds of various performance techniques. In conventional instruments, different Voices having those sounds would be called up via MIDI and played in combination to achieve the desired effect. However, now with MegaVoices, a convincing guitar part can be played with just a single Voice, using specific velocity values to play the desired sounds. Because of the complex nature of these Voices and the precise velocities need to play the sounds, they’re not intended for playing from the keyboard. They are, however, very useful and convenient when creating MIDI data—especially when you want to avoid using several different Voices just for a single instrument part.</p> <p> <b>NOTE</b></p> <p>To find and call up the “MegaVoice” folder, touch  (Up) at the bottom right of the Voice Selection display (when Preset is selected), and then select page 2.</p>

 **NOTE**

- S.Art and MegaVoices are not compatible with other instrument models. For this reason, any Song or Style you’ve created on this instrument using these Voices will not sound properly when played back on the instruments which do not have these types of Voices.
- S.Art and MegaVoices sound differently depending on keyboard range, velocity, touch, etc. Hence, if you turn on the [HARMONY/ARPEGGIO] button, change the transpose setting or change the Voice Edit parameters, unexpected or undesired sounds may result.

 **NOTE**

To find and call up the “Legacy” folder, touch  (Up) at the bottom right of the Voice Selection display (when Preset is selected), and then select page 2. This folder contains previous Yamaha keyboards’ Voices (such as the PSR-S series) for data compatibility with other models.

## Registering Files to the Favorite Tab

The procedure of registering your favorite preset Voices to the Favorite Tab is same as that of Styles. For instructions, refer to [page 7](#).

## Metronome Settings

You can make metronome and Tap Tempo settings on the display called up via [MENU] → [Metronome].

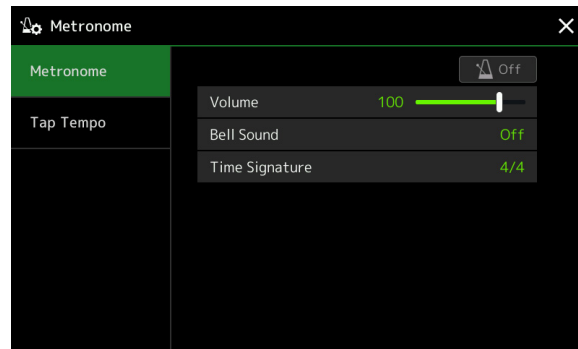

### Metronome

On/Off	For turning the metronome on or off.
Volume	Determines the volume of the metronome sound.
Bell Sound	Determines whether a bell accent is sounded or not at the first beat of each measure.
Time Signature	Determines the time signature of the metronome sound.

### Tap Tempo

Volume	Adjusts the volume of the sound triggered when the [RESET/TAP TEMPO] button is pressed.
Sound	Selects the percussion instrument for the sound triggered when the [RESET/TAP TEMPO] button is pressed.
Style Section Reset	Determines whether “reset” the playback position of the Style section when tapping the [RESET/TAP TEMPO] button during playback of the Style.



# Keyboard/Joystick-related Settings

## Setting the Touch Response of the Keyboard

Touch Response determines how the sound responds to your playing strength. The selected Touch Response type becomes the common setting for all Voices.

You can make the settings on the display called up via [MENU] → [Keyboard/Joystick] → [Keyboard].

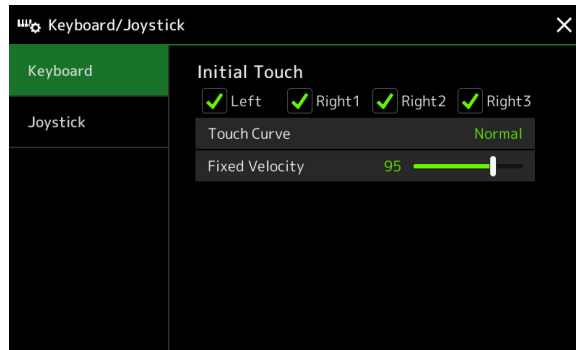

### NOTE

Some Voices are purposely designed without Touch Response, in order to emulate the true characteristics of the actual instrument (for example, conventional organs, which have no Touch Response).

## Initial Touch

Touch Curve	Determines the Initial Touch response type. Make sure to enter checkmarks to the boxes of the desired keyboard parts. <ul style="list-style-type: none"><li>• <b>Normal:</b> Standard Touch Response.</li><li>• <b>Soft 1:</b> Produces high volume with moderate playing strength. Lower volume is harder to be produced.</li><li>• <b>Soft 2:</b> Produces high volume even with light playing strength. Best for players with a light touch.</li><li>• <b>Hard 1:</b> Requires moderately strong playing for higher volume.</li><li>• <b>Hard 2:</b> Requires strong playing to produce high volume. Best for players with a heavy touch.</li></ul>
Fixed Velocity	Determines the fixed volume level when the Touch Response is set to off. The volume of the keyboard parts without checkmarks stays fixed regardless of your playing strength.

## Making the Joystick Settings

You can set whether the effects controlled by the joystick will be applied independently to each keyboard part or not from the display called up via [MENU] → [Keyboard/Joystick] → [Joystick].

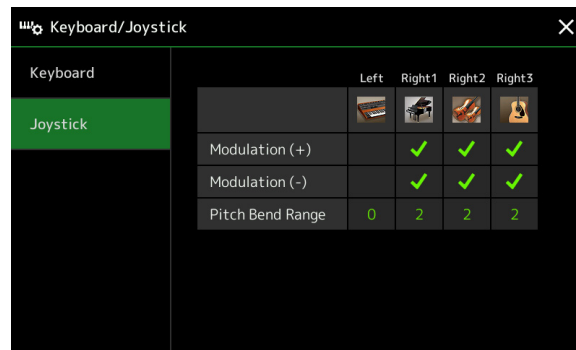

Modulation (+), (-)	Determines the keyboard parts to which the modulation effects are applied when moving the joystick in a vertical direction. Enter the checkmarks to the desired part.
Pitch Bend Range	Determines the pitch bend range for each keyboard part which is affected by moving the joystick in a horizontal direction. The range is from “0” to “12” with each step corresponding to one semitone.

# Keyboard Part-related Settings (Voice Setting)

This section covers the keyboard part settings and other Voice related settings which can be set on the display called up via [MENU] → [Voice Setting].

 **NOTE**

The display can also be called up from [Menu] on the Voice Selection display.

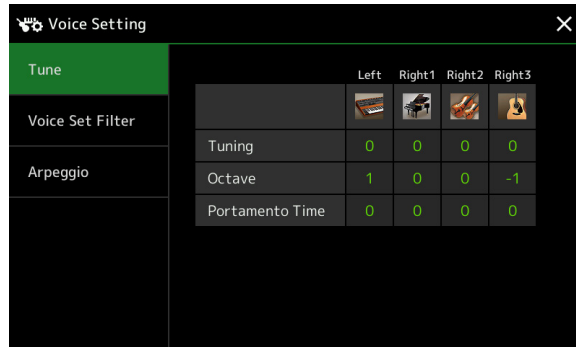

## Tune

Lets you adjust the pitch related parameters for each keyboard part.

Tuning	Determines the pitch of each keyboard part.
Octave	Determines the range of the pitch change in octaves, over two octaves up or down for each keyboard part.
Portamento Time	Portamento is a function that creates a smooth transition in pitch from the first note played on the keyboard to the next. The Portamento Time determines the pitch transition time. Higher values result in a longer pitch change time. Setting this to “0” results in no effect. This parameter is available for keyboard parts which are set to “Mono” (page 47).

## Voice Set Filter

Each Voice is linked to its default Voice Set parameter settings, equivalent to those in the Voice Edit display (page 46) for the Voices other than the Organ Flutes Voices. Although usually these settings are automatically called up by selecting a Voice, you can also disable this feature. For example, if you want to change the Voice yet keep the same Harmony effect, remove the checkmark of “Keyboard Harmony/Arpeggio.”

## Arpeggio

### Arpeggio

Quantize	Determines the timing of the Arpeggio Quantize function. Arpeggio playback is synchronized with Song or Style playback, and any slight imperfections are corrected in this timing.
Hold	Turns the Arpeggio Hold function on or off. When this is set to “On”, turning the [HARMONY/ARPEGGIO] button on makes Arpeggio playback continue even after the note has been released. To stop playback, press the [HARMONY/ARPEGGIO] button again.

## Transposing the Pitch in Semitones

You can transpose the overall pitch of the instrument (the keyboard sound, Style playback, MIDI Song playback, and so on) in semitone steps.

The operation display can be called up via [MENU] → [Transpose].

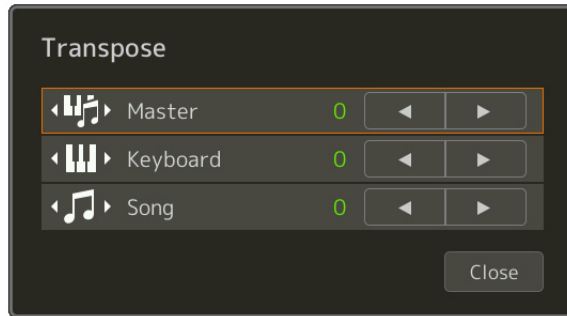

Master	Transposes the pitch of the entire sound, with the exception of the Audio Song and input sound from a microphone or the AUX IN jack.
Keyboard	Transposing the keyboard pitch including the chord root for triggering Style playback.
Song	Transposes the pitch of the MIDI Song.

### **NOTE**

You can also transpose the pitch by using the TRANSPOSE [-]/[+] buttons.

### **NOTE**

The pitch of an Audio Song is adjusted via the Pitch Shift function. Refer to the Owner's Manual.

### **NOTE**

Transpose is not applied to the Drum Kits and SFX Kits Voice.

## Fine Tuning the Pitch of the Entire Instrument (Master Tune)

You can fine-tune the pitch of the entire instrument in 0.2 Hz steps—useful when you play the PSR-SX900/SX700 along with other instruments or CD music. Note that the Tune function does not affect the Drum Kit or SFX Kit Voices and Audio Songs.

The operation display can be called up via [MENU] → [Master Tune].

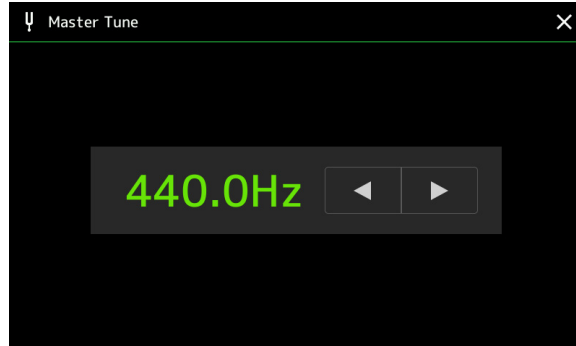

To restore the default initial setting (440.0 Hz), touch and hold down the setting value for a while.

## Selecting or Creating a Temperament (Scale Tune)

You can change the temperament of the instrument to fit the music you want to play. The operation display can be called up via [MENU] → [Scale Tune].

There are two way to change the temperament; Main Scale and Sub Scale.

- **Main Scale:**

Sets the basic scale of the instrument. You can choose from an existing scale type or adjust it manually. The setting can be saved and called up by the Registration Memory function.

- **Sub Scale:**

Temporarily changes the scale only while the Sub Scale is enabled (e.g., selected on the Scale Tune display). This lets you temporarily set a Scale Tune setting (which is different from the Main Scale setting) to the desired parts. This setting takes priority over the Main Scale setting, regarding the checkmarked parts (see below). You can adjust the setting manually, but it cannot be saved.

You can disable/enable the Sub Scale by touching “Main/Sub” on the display, or by using the function “Scale Tune Quick Setting” that can be set to the assignable buttons or foot pedals (page 116).

For which settings are applied to each part depending on the checkmarks on the display, see the examples below.

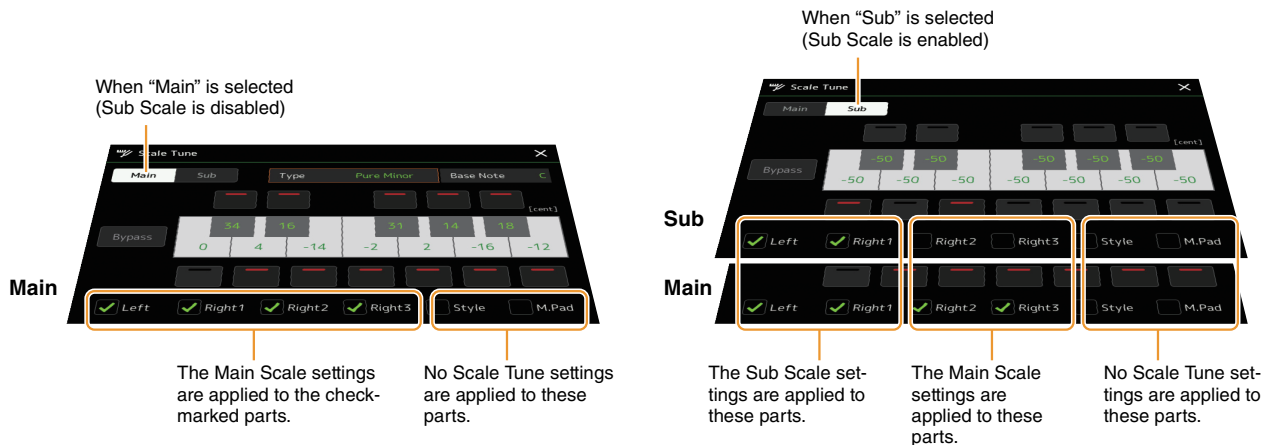

# Selecting or Creating a Temperament from the Preset Types (Main Scale)

You can select various scales for playing in custom tunings for specific historical periods or music genres.

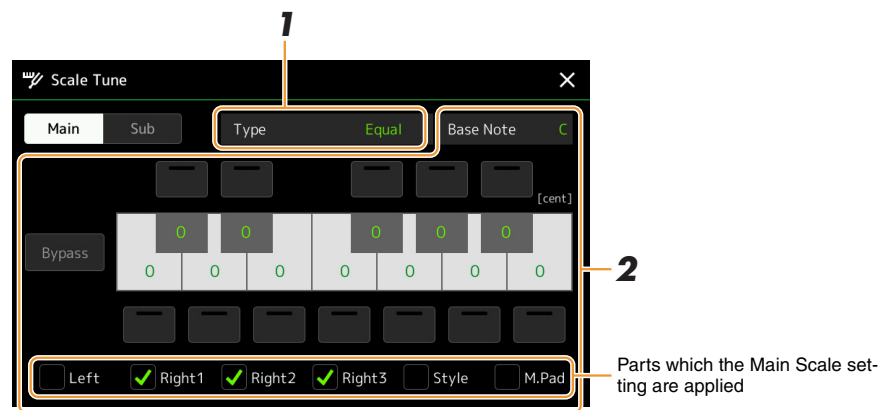

## 1 Select the desired Scale type (temperament).

Type	<ul style="list-style-type: none"> <li>• <b>Equal:</b> The pitch range of each octave is divided equally into twelve parts, with each half-step evenly spaced in pitch. This is the most commonly used tuning in music today.</li> <li>• <b>Pure Major, Pure Minor:</b> These tunings preserve the pure mathematical intervals of each scale, especially for triad chords (root, third, fifth). You can hear this best in actual vocal harmonies—such as choirs and a cappella singing.</li> <li>• <b>Pythagorean:</b> This scale was devised by the famous Greek philosopher and is created from a series of perfect fifths, which are collapsed into a single octave. The 3rd in this tuning is slightly unstable, but the 4th and 5th are beautiful and suitable for some leads.</li> <li>• <b>Mean-Tone:</b> This scale was created as an improvement on the Pythagorean scale, by making the major third interval more “in tune.” It was especially popular from the 16th century to the 18th century. Handel, among others, used this scale.</li> <li>• <b>Werckmeister, Kirnberger:</b> This composite scale combines the Werckmeister and Kirnberger systems, which were themselves improvements on the mean-tone and Pythagorean scales. The main feature of this scale is that each key has its own unique character. The scale was used extensively during the time of Bach and Beethoven, and even now it is often used when performing period music on the harpsichord.</li> <li>• <b>Arabic1, Arabic2:</b> Use these tunings when playing Arabic music.</li> </ul>
------	--

## 2 Change the following settings as necessary.

Base Note	Determines the base note for each scale. When the base note is changed, the pitch of the keyboard is transposed, yet maintains the original pitch relationship between the notes.
Tune	<p>Touch the desired key on the keyboard illustration to be tuned and tune it in cents. The boxes at the upper and lower side of each key determines whether the tune setting is applied to the note. You can turn this on/off by touching it when the value is something other than 0. If you edit this parameter, “(Edited)” is shown at the right of “Type” in step 1.</p> <p> <b>NOTE</b> In musical terms a “cent” is 1/100th of a semitone. (100 cents equal one semitone.)</p>
Bypass	Turning this on disables all the Scale Tune settings temporarily. This lets you hear the sound for comparison purposes.
Parts	Checkmark the part to which the Main Scale setting is applied.

### To store the Scale Tune (Main Scale) settings:

If you want to store the Scale Tune (Main Scale) settings, use the Registration Memory. Press the [MEMORY] button in the REGISTRATION MEMORY section, then checkmark “Scale Tune” and press one of the REGISTRATION MEMORY [1]–[8] buttons to register the Scale Tune settings.

# Creating and Using a Temperament Temporarily (Sub Scale)

You can change the scale temporarily by using the Sub Scale setting. This setting, when being edited, takes priority over the Main Scale setting. The setting is effective only while the Sub Scale is enabled (e.g., “Sub” is selected on the Scale Tune display).

## 1 On the Scale Tune display, touch [Sub] to select the Sub Scale setting.

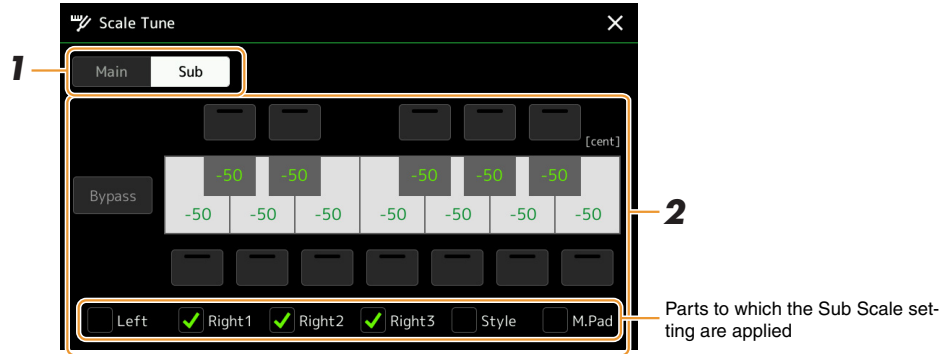

The Sub Scale setting is applied to checkmarked parts on bottom of the display. Even if the Sub Scale is selected, the Main Scale setting is applied to the parts which are not checkmarked on bottom of the Sub Scale display but checkmarked on the Main Scale display.

## 2 Change the following settings.

Tune	Touching the boxes at the upper and lower side of the keyboard illustration lets you easily lower the pitches of the desired note by 50 cents. Turning the boxes on/off lets you determine whether the tune setting is applied to the note or not. You can adjust the tune value by touching the desired key illustration and tune it in cents.
Bypass	Turning this on disables all the Scale Tune settings temporarily. This lets you hear the sound for comparison purposes.
Parts	Checkmark the part to which the Sub Scale setting is applied.

If you return to the home display in this condition, the Sub Scale setting remains enabled.

## 3 To stop using the Sub Scale setting, touch [Main] on the Scale Tune display.

The Sub Scale setting is disabled, and all the Sub Scale tune settings are reset to their default values.

### NOTE

The Sub Scale setting is also disabled and reset to default when the power of instrument is turned off.

### NOTE

You can enable/disable the Sub Scale setting and make the Sub Scale setting quickly, using the function “Scale Tune Quick Setting,” which can be assigned to the assignable buttons or foot pedals. For details, see [page 116](#).

# Making Detailed Settings for Harmony/Arpeggio

You can make various settings for the Keyboard Harmony and Arpeggio functions, including volume level. The operation display can be called up via [MENU] → [Kbd Harmony/Arp].

## 1 Select the desired Harmony/Arpeggio category and type.

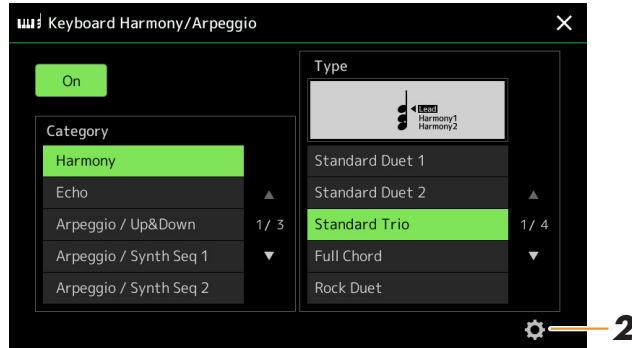

## 2 Touch (Setting) to call up the detailed settings window.

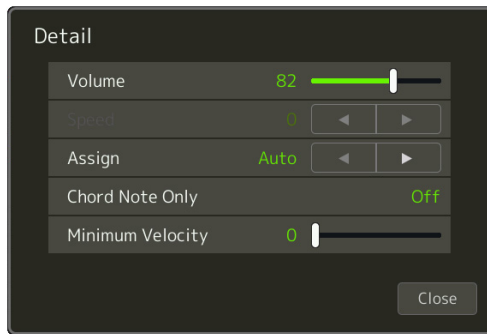

## 3 Make various Harmony/Arpeggio settings as desired.

When any one of the Arpeggio types is selected, only the parameters indicated by “\*” in the list below can be set. None of the parameters in the list below are available when the Harmony category “Multi Assign” type is selected.

Volume*	<p>Determines the volume level of the Harmony/Arpeggio notes generated by the Harmony/Arpeggio function.</p> <p> <b>NOTE</b></p> <p>When you are using certain Voices, such as Organ Voices, in which the “Touch Sensitivity Depth” is set to 0 in the Voice Edit display (page 47), the volume does not change.</p>
Speed	<p>This parameter is only available when the “Echo” category (Echo, Tremolo, or Trill) is selected. It determines the speed of the Echo, Tremolo, and Trill effects.</p>

 NEXT PAGE



Assign*	<p>Determines the keyboard part to which the effect is assigned.</p> <ul style="list-style-type: none"> <li>• <b>Auto:</b> Applies the effect to the part (Right 1–3) for which PART ON/OFF is on. If the Harmony/Echo category is selected, the parts are prioritized in the following order: Right 1, Right 2, Right 3 (when all parts are on).</li> <li>• <b>Multi:</b> This parameter is available when the Harmony/Echo category is selected. When multiple parts are on, the note played on the keyboard is sounded by the Right 1 part and the harmony sounds (effect) are divided to Right 1 and the other parts. When only one part is on, the note played on the keyboard and effect are sounded by that part.</li> <li>• <b>Right 1, Right 2, Right 3:</b> Applies the effect to the selected part (Right 1, Right 2 or Right 3).</li> </ul> <p> <b>NOTE</b></p> <p>When the “Harmony” category is selected, the keyboard part which is set to Mono and Legato type is selected (page 47) for the Voice is regarded as off. For example, when Right 1 is set to Legato (Mono) and Right 2 is set to Poly, and both parts are turned on, turning the [HARMONY/ARPEGGIO] button on applies the Harmony effect only to the Right 2 part.</p>
Chord Note Only	<p>This parameter is only available when the “Harmony” category is selected. When this is set to “On,” the Harmony effect is applied only to the note (played in the right-hand section of the keyboard) that belongs to a chord played in the chord section of the keyboard.</p>
Minimum Velocity	<p>Determines the lowest velocity value at which the Harmony, Echo, Tremolo, or Trill note will sound. This allows you to selectively apply the harmony by your playing strength, letting you create harmony accents in the melody. The harmony effect is applied when you play the key strongly (above the set value).</p>

 **NOTE**

The settings for the Arpeggio Quantize function and the Arpeggio Hold function can be made on the display called up via [MENU] → [Voice Setting] → [Arpeggio] (page 39).

## Editing Voices (Voice Edit)

The Voice Edit feature allows you to create your own Voices by editing some parameters of the existing Voices. Once you've created a Voice, you can save it as a file to internal memory (User drive) or external devices for future recall. This section covers the editing of Voices other than Organ Flutes Voices, since they have different editing methods than described here. For instructions on editing the Organ Flutes Voices, see [page 50](#).

- 1 Select the desired Voice (other than an Organ Flutes Voice).**
- 2 On the Voice Selection display, touch  (Menu) then [Voice Edit] to call up the Voice Edit display.**
- 3 Select the desired parameter then edit the value.**

For information about the editable parameters, refer to pages [47–49](#).

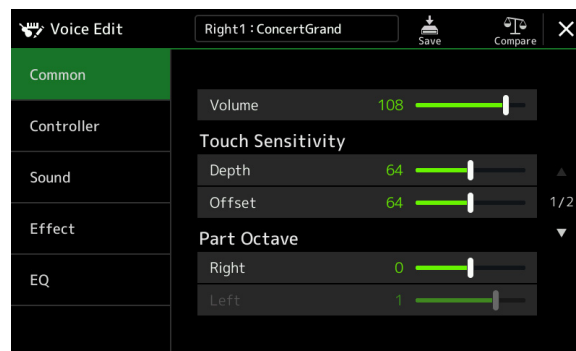

By touching  (Compare) repeatedly, you can compare the sound of the edited Voice with the original (unedited) Voice.

- 4 Touch  (Save) to save the edited Voice.**

### NOTE

The display can also be called up via [MENU] → [Voice Edit].

### NOTICE

The settings will be lost if you select another Voice or turn the power to the instrument off without carrying out the Save operation.

### NOTE





If you want to edit another Voice, touch the Voice name at the top of the Voice Edit display to select the keyboard part. Or, press one of the PART SELECT buttons to select the part to which the desired Voice is assigned, confirm the Voice name at the top of the Voice Edit display, make the edits as desired, then carry out the Save operation.

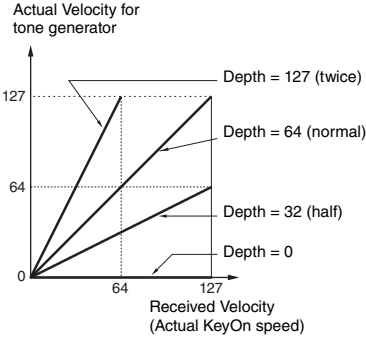
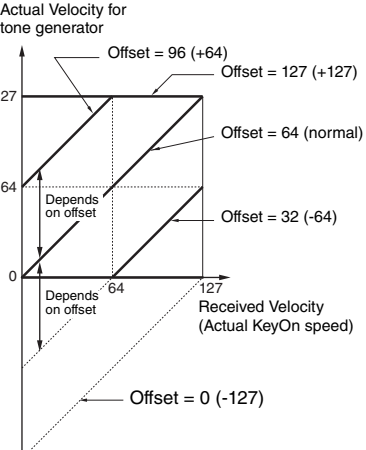

### Disabling Automatic Selection of Voice Sets (Effects, etc.)

Each Voice is linked to its default Voice Set parameter settings, equivalent to those in the Voice Edit display. Although usually these settings are automatically called up when a Voice is selected, you can also disable this feature by making appropriate settings in the “Voice Set Filter” display. Refer to [page 39](#), for details.

# Editable Parameters in the Voice Edit display

## Common

Volume	Adjusts the volume of the currently edited Voice.	
Touch Sensitivity	Depth	<p>Adjusts the touch sensitivity (velocity sensitivity), or how greatly the volume responds to your playing strength.</p> <div style="display: flex; justify-content: space-around;"> <div style="width: 45%;"> <p><b>Touch Sensitivity Depth</b> Changes to velocity curve according to Velocity Depth (with Offset set to 64)</p>  </div> <div style="width: 45%;"> <p><b>Touch Sensitivity Offset</b> Changes to velocity curve according to Velocity</p>  </div> </div> <ul style="list-style-type: none"> <li>• <b>Depth:</b> Determines the velocity sensitivity, or how much the level of the Voice changes in response to your playing strength (velocity).</li> <li>• <b>Offset:</b> Determines the amount by which received velocities are adjusted for the actual velocity effect.</li> </ul>
	Offset	
Part Octave	Right	Shifts the octave range of the edited Voice up or down in octaves. When the edited Voice is used as any of the Right 1–3 parts, the Right 1/Right 2/Right 3 parameter is available; when the edited Voice is used as the Left part, the Left parameter is available.
	Left	
Mono	Mono/Poly	<p>Determines whether the edited Voice is played monophonically or polyphonically.</p> <p> <b>NOTE</b></p> <p>When using a Voice set to “Mono,” the selection rules of the note to be played change automatically, depending on which part is using the Voice, and the status of other parts.</p> <ul style="list-style-type: none"> <li>• When using a Mono Voice for any of the Right 1-3 parts: <ul style="list-style-type: none"> <li>- Highest note; when a Poly Voice is selected for other enabled Right 1-3 parts.</li> <li>- Latest note; when a Mono Voice is selected for all other enabled Right 1-3 parts.</li> </ul> </li> <li>• When using a Mono Voice for the Left part: <ul style="list-style-type: none"> <li>- Latest note (not affected by the status of other parts)</li> </ul> </li> </ul>
	Mono Type	<p>Determines the behavior of the notes of decaying sounds, such as a guitar, when they are played with legato with the edited Voice set to “Mono” above.</p> <ul style="list-style-type: none"> <li>• <b>Normal:</b> The next note sounds after the previous note is stopped.</li> <li>• <b>Legato:</b> The sound of the previously played note is maintained and only the pitch changes to that of the next note.</li> <li>• <b>Crossfade:</b> The sound smoothly transitions from the previously played note to the next note.</li> </ul> <p> <b>NOTE</b></p> <ul style="list-style-type: none"> <li>• This parameter is unavailable for Super Articulation Voices and Drum/SFX Kit Voices, and behaves the same as the “Normal” setting when these Voices are selected.</li> <li>• When Legato or Crossfade is selected, the behavior (other than what is described here) may be different from Normal, depending on the panel settings.</li> </ul>
	Portamento Time	<p>Determines the portamento time (pitch transition time) when the edited Voice is set to “Mono” above.</p> <p> <b>NOTE</b></p> <p>Portamento is a function that creates a smooth transition in pitch from the first note played on the keyboard to the next.</p>

Mono	Portamento Time Type	<p>Determines how an actual pitch transition time is calculated from the Portamento Time value.</p> <ul style="list-style-type: none"> <li>• <b>Fixed Rate:</b> Make the pitch change rate to 0: max., 127: min. The actual pitch transition time varies according to the interval between the two notes.</li> <li>• <b>Fixed Time:</b> Make the actual pitch transition time to 0: min., 127: max. The pitch change rate varies according to the interval between the two notes.</li> </ul> <p> <b>NOTE</b></p> <ul style="list-style-type: none"> <li>• The basic rule of Portamento Time is unchanged even if this setting is changed. When the value of Portamento Time is smaller, the actual time is shorter; when the value is larger, the actual time is longer.</li> <li>• The greater the value of Portamento Time, the clearer the effect of this setting will be.</li> </ul>
Panel Sustain	Determines the sustain level applied to the edited Voice when the [SUSTAIN] button on the panel is turned on.	
Kbd Harmony/Arpeggio	Basically the same as in the display called up via [MENU] → [Kbd Harmony/Arp], except that  (Setting) is located at a different position. Refer to the Owner's Manual and "Making Detailed Settings for Harmony/Arpeggio" on page 44.	

## Controller

Modulation (+), Modulation (-)	The joystick can be used to modulate the parameters below as well as the pitch (vibrato). Here, you can set the degree to which the joystick modulates each of the following parameters.	
	Filter	Determines the degree to which the joystick modulates the Filter Cutoff Frequency. For details about the filter, see below.
	Amplitude	Determines the degree to which the joystick modulates the amplitude (volume).
	LFO Pitch	Determines the degree to which the joystick modulates the pitch, or the vibrato effect.
	LFO Filter	Determines the degree to which the joystick modulates the Filter modulation, or the wah effect.
	LFO Amplitude	Determines the degree to which the joystick modulates the amplitude, or the tremolo effect.

## Sound

Filter	Filter is a processor that changes the timbre or tone of a sound by either blocking or passing a specific frequency range. The parameters below determine the overall timbre of the sound by boosting or cutting a certain frequency range. In addition to making the sound either brighter or mellower, Filter can be used to produce electronic, synthesizer-like effects.	
	Cutoff	<p>Determines the cutoff frequency or effective frequency range of the filter (see diagram). Higher values result in a brighter sound.</p>
Resonance	<p>Determines the emphasis given to the cutoff frequency (resonance), set in Cutoff above (see diagram). Higher values result in a more pronounced effect.</p>	

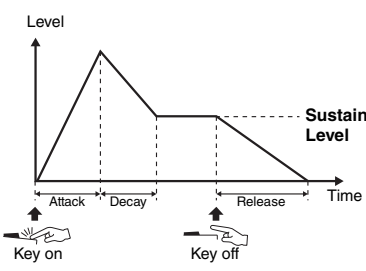
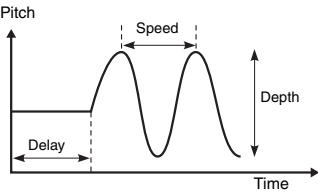
EG	<p>The EG (Envelope Generator) settings determine how the level of the sound changes in time. This lets you reproduce many sound characteristics of natural acoustic instruments—such as the quick attack and decay of percussion sounds, or the long release of a sustained piano tone.</p> 	
Attack	<p>Determines how quickly the sound reaches its maximum level after the key is played. The lower the value, the quicker the attack.</p> <p><b>NOTE</b> Some Voices (such as Piano and E. Piano Voices) may not be affected by the setting here.</p>	
Decay	<p>Determines how quickly the sound reaches its sustain level (a slightly lower level than maximum). The lower the value, the quicker the decay</p>	
Release	<p>Determines how quickly the sound decays to silence after the key is released. The lower the value, the quicker the decay.</p>	
Vibrato	<p>Vibrato is a quavering, vibrating sound effect that is produced by regularly modulating the pitch of the Voice.</p> 	
Depth	<p>Determines the intensity of the Vibrato effect. Higher settings result in a more pronounced Vibrato.</p>	
Speed	<p>Determines the speed of the Vibrato effect.</p>	
Delay	<p>Determines the amount of time that elapses between the playing of a key and the start of the Vibrato effect. Higher settings increase the delay of the Vibrato onset.</p>	

**Effect**

Insertion Effect	On/Off	Turns the Insertion Effects on or off.
	Type	Selects the Insertion Effect type. Select the Category then select the Type. You can adjust the detailed parameters by touching  (Setting) and save them. Refer to “Editing and Saving the Effect Settings” (page 106) for details.
	Depth	Adjusts the Insertion Effect depth.
Reverb Depth	Adjusts the Reverb depth.	
Chorus Depth	Adjusts the Chorus depth.	

**EQ**

Determines the Frequency and Gain of the EQ bands. For information about EQ, refer to [page 103](#).

# Editing Organ Flutes Voices (Voice Edit)

The Organ Flutes Voices can be edited by adjusting the footage levers, adding the attack sound, applying effect and equalizer, etc.

There are three organ types, and each organ type has its own display, which beautifully recreates the actual appearance of an actual instrument. Each type provides realistic, intuitive control over the sound with special footage levers, tabs and switches—letting you adjust the sound with much the same feel as on an actual instrument.



## 1 Select the desired Organ Flutes Voice.

Touch [Organ] in the sub categories, then select the desired Organ Flutes Voice.

## 2 On the Voice Selection display, touch (Menu) then [Voice Edit] to call up the Voice Edit display.

### NOTE

The Voice Edit display for the Organ Flutes Voices can also be called up by touching the Organ Flutes icon at lower right of the Organ Flutes Voice name in the Home display or the Voice Part Setup display. It can also be called up via [MENU] → [Voice Edit].

## 3 Select the desired parameter then edit the value.

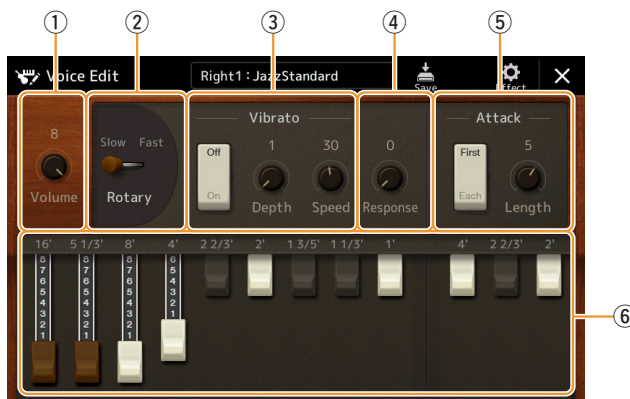

The parameters indicated by “\*” are available only for the Vintage and Home type. The type of the selected Organ Flutes Voice can be distinguished by the Voice Edit display design as described above.

①	Volume	Adjusts the overall volume of the Organ Flutes.
②	Rotary/Tremolo*	Alternately switches the Rotary Speaker speed between “Slow” and “Fast.” This parameter is available only when an effect (page 49) which contains “Rotary” in its name is applied.
③	Vibrato*	Turns on or off the vibrato, and adjusts its depth and speed.
④	Response	Affects both the attack and release (page 49) portion of the sound, increasing or decreasing the response time of the initial swell and release, based on the Footage controls. The higher the value, the slower the swell and release.

⑤	Attack	Selects “First” or “Each” as the Attack mode and adjusts the Attack length of the sound. In the First mode, attack (percussive sound) is applied only to the first notes played and held simultaneously; while the first notes are held, any subsequently played notes have no attack applied. In the Each mode, attack is applied equally to all notes. The Attack length produces a longer or shorter decay immediately after the initial attack. The longer the value, the longer the decay time.
⑥	Footage	Determines the basic sound of the Organ Flutes.

**4** As necessary, touch  (Effect) then set the parameters related to the Effects and EQ.

The parameters are same as those in the Effect display and EQ display of the previous chapter “Editing Voices (Voice Edit)” (page 49).

**5** Touch  (Save) to save the created Organ Flutes Voice.

**NOTICE**

The settings will be lost if you select another Voice or turn the power to the instrument off without carrying out the Save operation.

 **NOTE**

If you want to edit another Voice, touch the Voice name at the top of the Voice Edit display to select the keyboard part. Or, press one of the PART SELECT buttons to select the part to which the desired Voice is assigned, confirm the Voice name at the top of the Voice Edit display, make the edits as desired, and then carry out the Save operation.

### Contents

Creating a Multi Pad via MIDI (Multi Pad Creator—MIDI Multi Pad Recording) .....	52
• Multi Pad—Realtime Recording via MIDI .....	52
• Multi Pad—Step Recording via MIDI .....	54
Creating a Multi Pad with Audio files (Multi Pad Creator—Audio Link Multi Pad) .....	54
• Playing the Audio Link Multi Pads .....	55
Editing Multi Pads.....	56

## Creating a Multi Pad via MIDI (Multi Pad Creator—MIDI Multi Pad Recording)

This feature lets you create your original Multi Pad phrases, and also allows you to edit existing Multi Pad phrases to create your own. As with MIDI Song recording, MIDI Multi Pad Recording features Realtime Recording and Step Recording. However, with MIDI Multi Pad Recording, each Multi Pad consists of only one channel and convenient recording functions such as Punch In/Out are not available.

### Multi Pad—Realtime Recording via MIDI

Before starting operation, note the following points:

- Since only the Right 1 part performance will be recorded as a Multi Pad phrase, you should select the desired Voice for the Right 1 part beforehand.
- The Super Articulation Voices and the Organ Flutes Voices cannot be used for Multi Pad Recording. If one of these Voices is set for the Right 1 part, it will be replaced with the Grand Piano Voice when recording.
- Since recording can be done along with and synchronized to Style playback, you should select the desired Style beforehand. However, keep in mind that the Style is not recorded.

**1** If you want to create a new Multi Pad in an existing Bank, select the desired Multi Pad Bank via the MULTI PAD CONTROL [SELECT] button.

If you want to create a new Multi Pad in an empty new Bank, this step is unnecessary.

**2** Call up the operation display via [MENU] → [M.Pad Creator] → [MIDI Multi Pad Recording].

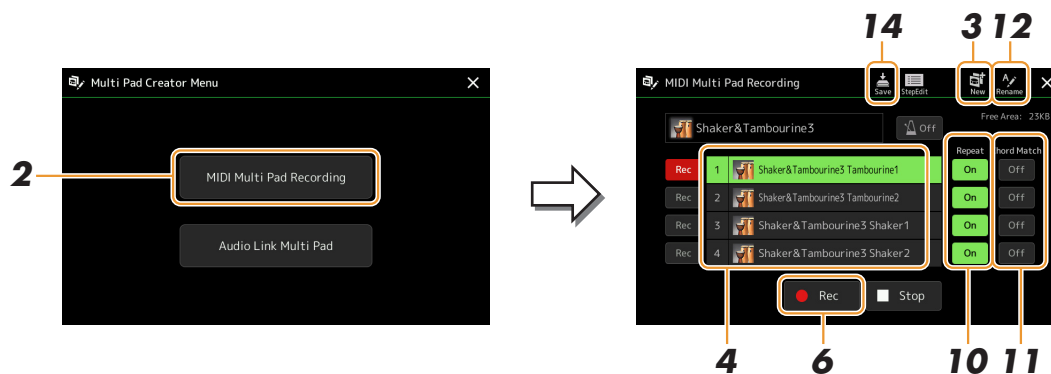

▶ NEXT PAGE



**3** If you want to create a new Multi Pad in an empty new Bank, touch  (New).

**4** Touch to select a particular Multi Pad for recording.

**5** If necessary, select the desired Voice via the PART SELECT [RIGHT 1] button.

After selecting the Voice, press the [EXIT] button to return to the previous display.

**6** Touch  (Rec) to enter recording standby status for the Multi Pad selected in step 4.

 **NOTE**

To cancel the recording, touch  (Rec) again before going on step 7.

**7** Play the keyboard to start recording.

To ensure that your recording will be in sync with the tempo, touch [Metronome] to turn on the metronome.

If you want to insert silence before the actual phrase, press the STYLE CONTROL [START/STOP] to start both the Recording and rhythm playback (of the current Style). Keep in mind that the rhythm part of the current Style plays back during recording although it is not recorded.

### Recommended notes for the Chord Match phrase

If you intend to create a Chord Match phrase, use the notes of C, D, E, G, A and B, or in other words, play the phrase in the key of C major. This ensures that the phrase will stay harmonically constant and match whichever chord you play in the left hand section of the keyboard.

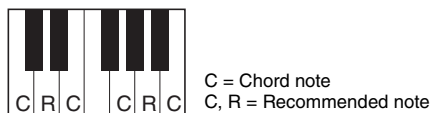

**8** Stop recording.

Press the MULTI PAD CONTROL [STOP] button or the STYLE CONTROL [START/STOP] button to stop recording when you've finished playing the phrase.

**9** Listen back to your newly recorded phrase, by pressing the appropriate MULTI PAD CONTROL [1]–[4] button. To re-record the phrase, repeat steps 6–8.

**10** Touch Repeat [On]/[Off] for each pad to turn it on or off.

If the Repeat parameter is on for the selected pad, playback of the corresponding pad will continue until the MULTI PAD CONTROL [STOP] button is pressed. When you press a Multi Pad for which Repeat is turned on during Song or Style playback, playback will start and repeat in sync with the beat.

If the Repeat parameter is off for the selected pad, playback will simply play back once and end automatically as soon as the end of the phrase is reached.

**11** Touch Chord Match [On]/[Off] for each pad to turn it on or off.

If the Chord Match parameter is on for the selected pad, the corresponding pad is played back according to the chord specified in the chord section of the keyboard generated by turning the [ACMP] on, or specified in the LEFT part of the keyboard generated by turning the [LEFT] on (when the [ACMP] is off).

**12** Touch  (Rename), and then enter the desired name for each Multi Pad.

**13** If you want to record other Multi Pads, repeat steps 4–12.

**14** Touch  (Save) to save the Multi Pad, and then save the Multi Pad data as a Bank containing a set of four Pads.

**NOTICE**

The edited Multi Pad data will be lost if you select another Multi Pad Bank or turn off the power to the instrument without carrying out the Save operation.

## Multi Pad—Step Recording via MIDI

Step Recording can be carried out in the Step Edit page. After selecting a Multi Pad in step 4 on [page 53](#), touch  (Step Edit) to call up the Step Edit page.

The Step Edit page indicates the Event list, which lets you record notes with absolutely precise timing. This Step Recording procedure is essentially the same as that for MIDI Song Recording ([page 77](#)), with the exception of the following point:

- In the Multi Pad Creator, only channel events and System Exclusive messages can be entered. Chord and Lyrics events are not available. You can switch between the two types of Event Lists by touching [Ch]/[SysEx].

## Creating a Multi Pad with Audio files (Multi Pad Creator—Audio Link Multi Pad)

You can create a new Multi Pad by making the links with audio files (WAV format: 44.1 kHz sample rate, 16 bit resolution) in the User drive and USB flash drive to each of the Multi Pad. The audio files (WAV) can be data you've recorded on this instrument as well as commercially available ones. Multi Pads to which audio files have been linked are called Audio Link Multi Pads. The new Audio Link Multi Pads can be saved to the User drive or USB flash drive.

### NOTE

An audio file cannot be linked to a MIDI Multi Pad.

- 1** If you want to use audio files (WAV) in a USB flash drive, connect the USB flash drive containing the data to the [USB TO DEVICE] terminal.

### NOTE

Before using a USB flash drive, be sure to read "Connecting USB Devices" in the Owner's Manual.

- 2** Call up the operation display via [MENU] → [M.Pad Creator] → [Audio Link Multi Pad].

### NOTE

The display can also be called up from [Menu] on the Multi Pad Selection display.

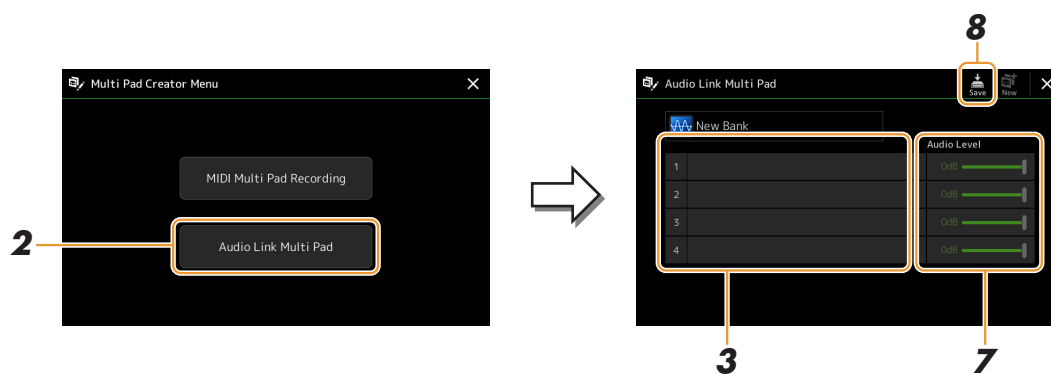

### NOTE

If an Audio Link Multi Pad has been selected when you call up the Audio Link Multi Pad display, the links made for the selected Pad appear. In order to create a new Pad, make sure to touch [New]. Otherwise, you are simply re-selecting the link in the selected Pad.

- 3** Touch to select the desired Pad.

The Audio File Selection display appears.



## 4 Select the desired audio file.

### To confirm the information of the selected audio file

By touching  (Menu) then [Song Information] on the File Selection display, you can confirm the information (title name, bit rate and sample rate, etc.).

## 5 Press the [EXIT] button to return to the Audio Link Multi Pad display.

## 6 If you want to link other audio files to other pads, repeat steps 3 to 5.

## 7 If desired, adjust the volume level of each audio file by touching the Audio Level slider.

By pressing the desired MULTI PAD CONTROL [1]–[4] button, you can adjust the volume while playing back the Multi Pad phrase.

## 8 Touch (Save) to save the Multi Pad, and then save the Audio Link Multi Pad data as a Bank containing a set of four Pads.

### NOTICE

The setting will be lost if you select another Audio Link Multi Pad or turn the power to the instrument off without carrying out the Save operation.

## 9 Press the MULTI PAD CONTROL [SELECT] button to check the new Audio Link Multi Pad in the Multi Pad Bank Selection display.

The newly created Audio Link Multi Pad is marked with “Audio Link” above the file name.

### If you want to change the Link setting:

Select the desired Audio Link Multi Pad, and then carry out the same operations as steps 2 to 9.

## Playing the Audio Link Multi Pads

You can play the Multi Pad to which the audio file is assigned by selecting them in the User or USB drive of the Multi Pad Bank Selection display. Although you can play via the same operations as the Multi Pad which has no links with audio files, note the following limitations.

- Make sure to connect the USB flash drive that includes the corresponding audio files.
- Automatic repeat playback is not available.
- Chord Match cannot be applied.

### NOTE

Audio files (WAV) take a slightly longer time than MIDI files to load.

### Enabling/disabling multiple simultaneous playback of the Audio Link Multi Pads

You can set whether the instrument plays back multiple Audio Link Multi Pads simultaneously or not, via the following parameter:

#### MULTI PAD CONTROL [SELECT] → [Menu]

Audio Link M.Pad “Simultaneous Play”

- **On:** Multiple Pads can be played back simultaneously. Even if you start playback of another Pad, the Pad already in playback will not stop.
- **Off:** Only one Pad will be played back at once. Playback is exclusive, so if you start playback of another Pad, the Pad already in playback will stop.

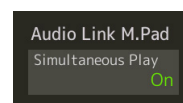

## Editing Multi Pads

You can manage (rename, copy, paste and delete) your created Multi Pad Bank and each of the Multi Pads belonging to the Bank. For instructions on managing the Multi Pad Bank file, refer to “Basic Operations” in the Owner’s Manual. This section covers how to manage each Multi Pad.

### 1 Select the Multi Pad Bank containing the Multi Pad to be edited.

Press the MULTI PAD CONTROL [SELECT] button to call up the Multi Pad Bank Selection display, and then select the desired Multi Pad Bank.

#### NOTE

If you select a Preset Multi Pad Bank and edit the Multi Pads, make sure to save your edits to User drive as a User Bank.

### 2 On the Multi Pad Bank Selection display, touch (Menu) then [Multi Pad Edit] to call up the Multi Pad Edit window.

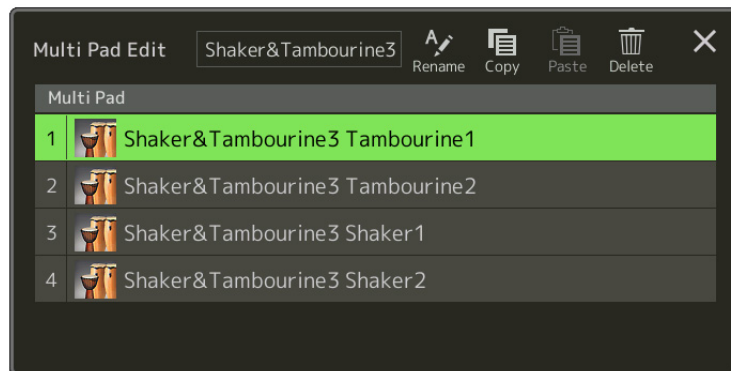

### 3 Select a particular Multi Pad to be edited.

### 4 Edit the selected Pad.

Rename	Changes the name of each Multi Pad.
Copy	Copies the selected Multi Pad (see below).
Paste	Pastes the copied Multi Pad.
Delete	Deletes the selected Multi Pad.

#### Copying the Multi Pad

- 1 Select the Multi Pad to be copied in step 4 above.
- 2 Touch [Copy].  
The selected Multi Pad is copied to the clipboard.
- 3 Select the destination location.  
If you want to copy the selected Pad to another bank, select the desired bank on the Multi Pad Bank Selection display, call up the Multi Pad Edit window via  (Menu), then select the destination.
- 4 Touch [Paste] to carry out the Copy operation.

#### NOTE

MIDI and Audio pads cannot exist in the same bank.

### 5 Save the current Bank containing the edited Multi Pads.

Press the [EXIT] button to call up the confirmation window, touch [Save] to call up the User drive, and then touch [Save here] to carry out the Save operation. For details, refer to “Basic Operations” in the Owner’s Manual.

## Contents

Creating a Song List for Playback .....	57
Using Repeat Playback Mode .....	58
Editing Music Notation (Score) Settings .....	59
• Play Setting .....	59
• View Setting .....	60
• Detail Setting .....	60
Displaying Lyrics and Setting Up the Display .....	61
Displaying Text and Setting Up the Display .....	62
Using the Auto Accompaniment Features with MIDI Song Playback .....	63
Turning Each Channel of a MIDI Song On/Off .....	64
Song Playback Related Settings .....	65
• Guide—Keyboard and Vocal Practice Using the Guide Function .....	65
• Part Ch .....	66
• Lyrics .....	66
• Play .....	66

## Creating a Song List for Playback

By adding your favorite Songs to the Song List, you can arrange desired Songs to be played back continuously, in whatever order you specify.

### 1 Press the [SONG] button to call up the Song Playback display.

Make sure that Song List mode is selected.

### 2 Touch (New) to create a new Song List.

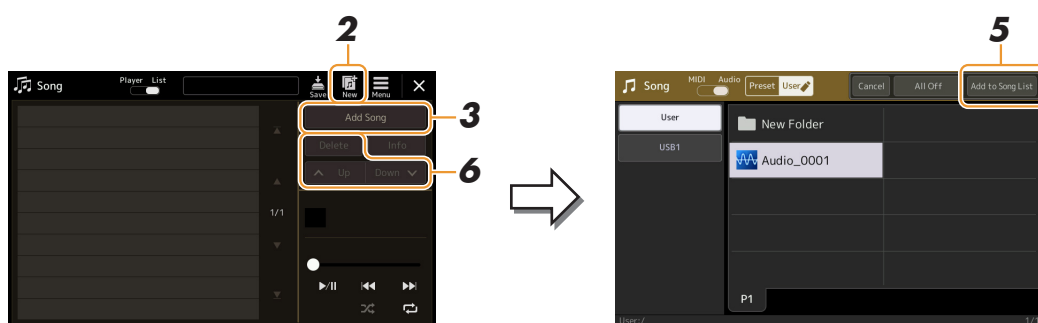

### 3 Touch [Add Song] to call up the Song Selection display.

### 4 Touch the desired Song names to add the selected Song(s) to the Song List.

For selecting from Audio Songs, touch [Audio].

For selecting from MIDI Songs, touch [MIDI].

If you want to add all Songs in the selected folder, touch [Select All].

## 5 Touch [Add to Song List] to add to the list.

The selected Songs are shown on the Song Playback display.

## 6 If necessary, edit the Song List.

- **Delete:** Delete the selected Song from the list.
- **Up:** Move the selected Song up in the list.
- **Down:** Move the selected Song down in the list.

## 7 Touch (Save) to save the Song List.

### NOTICE

The created Song List will be lost if you select another Song List or turn off the power to the instrument without carrying out the Save operation.

## Using Repeat Playback Mode

From the Song Playback display called up via the [SONG] button, you can set how playback of the current Song is repeated.

### Song Player mode

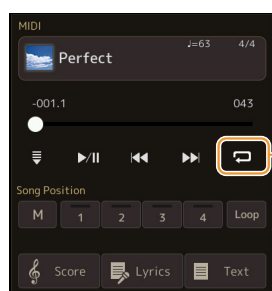



(Common for MIDI and Audio Songs)

Turns the Single Repeat mode on or off. When turned on, the selected Song plays back repeatedly.

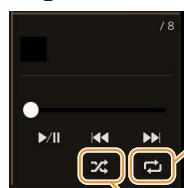
### Song List mode



Touching here switches the Repeat mode.

-  **(Off):** The Repeat mode is off. All Songs in the selected Song List play back once, and playback stops automatically at the end of the last Song in the list.
-  **(All Repeat):** All Songs in the selected Song List play back repeatedly.
-  **(Single Repeat):** Only the selected Song plays back repeatedly.

Turning  **(Shuffle)** on shuffles the order of the Songs in the selected Song List. Turning it off resets to the original order.

## Editing Music Notation (Score) Settings

Select a MIDI Song in the Song Player mode of the Song Playback display, and then touch [Score] to call up the music notation of the current MIDI Song. You can change the notation indication as desired to suit your personal preferences.

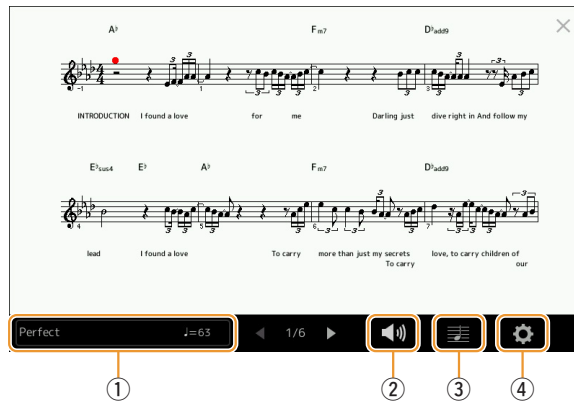

①	Indicates the name of the current Song. Also, the tempo value is shown at the right end. If you want to change the Song, touch the Song name to call up the Song Selection display.
②	For setting the parameters related to playback Parts of the MIDI Song. For details, refer to “Play Setting” (page 59).
③	For setting the notation indication parameters, including notation size, chord display, etc. For details, refer to “View Setting” (page 60).
④	For setting detailed parameters related to the notation indication. Refer to “Detail Setting” (page 60).

### NOTE

The Score display can also be called up via [MENU] → [Score].



## Play Setting

From the display called up via (Play Setting), you can set the parameters related to playback of the current MIDI Song.

Extra	Turns playback of all Channels on or off, except for those assigned to the Left and Right Hand Parts described below.
Left	Turns playback on or off for the Left Hand Part, to which you can assign the desired channel on the Song Setting display (page 66).
Right	Turns playback on or off for the Right Hand Part, to which you can assign the desired channel on the Song Setting display (page 66).
Guide	Turns the Guide function on or off. For details, refer to page 65.

## View Setting

From the display called up via  (View Setting), you can set the parameters related to the view of the notation.

Size	Changes the size of the notation.
Left	<p>Turns indication of the left-hand notation on or off. If an “-” indication appears at this parameter and is unavailable, go to the “Detail Setting” display (page 60), then set the Left Ch to any channel except “Auto.” Or, on the display called up via [MENU] → [Song Setting] → [Part Ch], then set the Left to any channel except “Off” (page 66).</p> <p> <b>NOTE</b></p> <p>Both Right (below) and Left cannot be turned off at the same time.</p>
Right	<p>Turns indication of the right-hand notation on or off.</p> <p> <b>NOTE</b></p> <p>Both Right and Left (above) cannot be turned off at the same time.</p>
Chord	Turns indication of the chords on or off. If the current Song does not contain chord data, no chord information is shown even if this is checked.
Lyrics	Turns indication of the Lyrics on or off. If the current Song does not contain lyrics data, no lyrics are shown even if this is checked. If the Song contains Pedal events, touching here switches between “Lyrics” and “Pedal.” When “Pedal” is checked, Pedal events are shown instead of Lyrics on the display.
Note	Turns indication of the Note names on or off. When this is checked, each note name is shown at the left side of each note. If the Song contains Fingering events, touching here switches between “Note” and “Fingering.” When “Fingering” is checked, Fingering events are shown instead of Note names on the display.
Color	When this is checked, the notes in the display appear in identifying colors (C: red, D: yellow, E: green, F: orange, G: blue, A: purple, and B: gray).

## Detail Setting

From the display called up via  (Detail Setting), you can set more detailed parameters.

Right Ch	<p>Determines which MIDI channel in the MIDI Song data is used for the right-hand/left-hand part. This setting returns to “Auto” when a different Song is selected.</p> <ul style="list-style-type: none"> <li>• <b>Auto:</b> The MIDI channels in the MIDI Song data for the right- and left-hand parts are assigned automatically — setting each part to the channel which has been specified at the Part Ch (page 66) on the Song Setting display.</li> <li>• <b>1–16:</b> Assigns a specified MIDI channel (1–16) to each of the right- and left-hand parts.</li> <li>• <b>Off (Left Ch only):</b> No channel assignment. This disables display of the left-hand notation.</li> </ul>
Left Ch	
Key Signature	Lets you enter the Key Signature at the current stopped position of the MIDI Song. This setting is useful for Songs you’ve recorded with key changes, so the key signature changes are properly reflected in the notation.
Quantize	This gives you control over the note resolution in the notation, letting you shift or correct the timing of all displayed notes so that they line up to a particular note value. Make sure to select the smallest note value used in the Song.
Note Name	<p>Selects the type of the note name indicated at the left of the note in the notation from among the following three types. The settings here are available when the Note parameter in “View Setting” is checked.</p> <ul style="list-style-type: none"> <li>• <b>A, B, C:</b> Note names are indicated as letters (C, D, E, F, G, A, B).</li> <li>• <b>Fixed Do:</b> Note names are indicated in solfeggio and differ depending on the selected language.</li> <li>• <b>Movable Do:</b> Note names are indicated in solfeggio according to the scale intervals, and as such are relative to the key. The root note is indicated as Do. For example, in the key of G major the root note of “Sol” would be indicated as “Do.” As with “Fixed Do,” the indication differs depending on the selected language.</li> </ul>



# Displaying Lyrics and Setting Up the Display

Not only MIDI Songs, but also Audio Songs can show lyrics, if the particular Song contains compatible lyrics data.

## 1 Select a Song in the Song Player mode of the Song Playback display.

## 2 Touch [Lyrics] to call up the Lyrics display.

If the Song contains compatible lyrics data, the lyrics are shown on the display. While the Song is playing back, the color of the lyrics changes, indicating the current position.

## 3 If necessary, make the desired settings.

### NOTE



The Lyrics display can also be called up via [MENU] → [Lyrics].

### NOTE

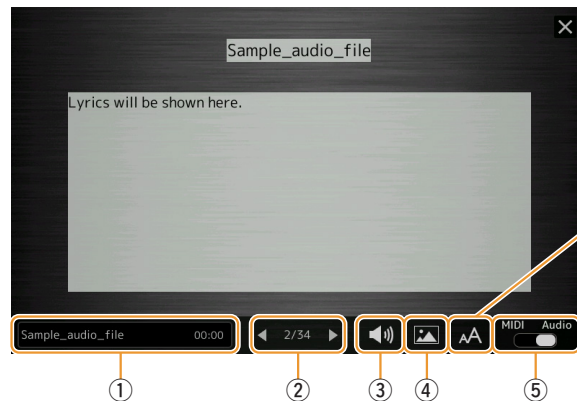
If the lyrics are garbled or unreadable, you can probably remedy this by changing the Lyrics Language setting on the display called up via [MENU] → [Song Setting] → [Lyrics].



For Audio Songs, this lets you select the font type from "Medium" or "Proportional Medium."

①	Indicates the name of the current Song. If you want to change the Song, touch the Song name here to call up the Song Selection display. For MIDI Songs, the current measure number is shown at the right end. For Audio Songs, the elapsed time is shown at the right end.
②	Indicates the current page and the entire page. If you want to look through the entire lyrics, touch [◀] or [▶] when Song is stopped.   <b>NOTE</b> Depending on the Song, the pages cannot be changed by touching [◀]/[▶].
③	<ul style="list-style-type: none"> <li>• <b>MIDI Song:</b> Lets you set the parameters related to playback Parts of the MIDI Song. For details, refer to "Play Setting" (page 59).</li> <li>• <b>Audio Song:</b> Lets you turn the Vocal Cancel function on or off. For details, refer to the Owner's Manual.</li> </ul>
④	Allows you to change the background picture of the Lyrics display and Text display. As well as various pictures provided in the Preset tab, you can select an original picture file (a bitmap file with no greater than 800 x 480 pixels) in the USB flash drive. The original picture file can be copied from the USB flash drive to the internal User memory.   <b>NOTE</b> The setting here is applied also to the Text display.
⑤	Lets you switch the Lyrics display between the MIDI Song and Audio Song.

### Priority of Lyrics data of an Audio Song (MP3 file)

When showing the lyrics data of an Audio Song (MP3 file), only one type of data (according to the priority order below) is shown:

- 1) CDG file (\*.cdg) with the same name of the MP3 file in the same folder.
- 2) Lyrics in the MP3 file with the LYRICSBEGIN tag.
- 3) Lyrics in the MP3 file with the SLT/SYLT tag.
- 4) Lyrics in the MP3 file with the ULT/USLT tag.
- 5) Text file (\*.txt) with the same name of the MP3 file in the same folder.

# Displaying Text and Setting Up the Display

You can view the text file (.txt) created by using a computer on the instrument's display. This feature enables various useful possibilities, such as the showing of lyrics, chord names, and text notes.

**1** In the Song Player mode of the Song Playback display, touch [Text] to call up the Text display.

 **NOTE**

The Text display can also be called up via [MENU] → [Text Viewer].

**2** Touch the bottom left corner on the display to call up the Text File Selection display.

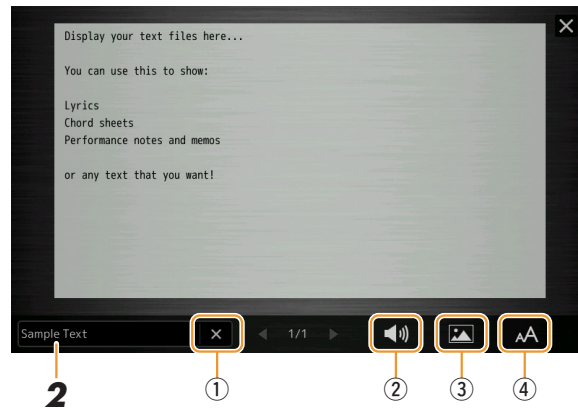

On the File Selection display, you can select a text file in the USB flash drive or text data copied to the internal User memory.

**3** Select the desired text file, and close the File Selection display to show the text in the display.

If the text extends over several pages, you can scroll through the entire text by touching [◀] or [▶], which are shown at the right and left of the page.

 **NOTE**

- Line breaks are not automatically entered in the instrument. If a sentence is not displayed in its entirety because of limitations in the screen space, enter line breaks manually on your computer by using a text editor, etc. beforehand.
- Information about Text File selection can be memorized to the Registration Memory. For details, refer to the Owner's Manual.

**4** If necessary, make the desired settings.

①	Clears the text from the display. This operation does not delete the text file itself, but simply leaves the display empty of any text file.
②	Lets you set the parameters related to playback Parts of the MIDI Song. For details, refer to “Play Setting” (page 59).
③	Allows you to change the background picture of the Lyrics display and Text display. As well as various pictures provided in the Preset tab, you can select your original picture file (a bitmap file with no greater than 800 x 480 pixels) in the USB flash drive. Your original picture file can be copied from the USB flash drive to the internal User memory.   <b>NOTE</b> The setting here is applied also to the Lyrics display.
④	Lets you select the font size or type. “Small,” “Medium,” or “Large” keeps each character at the same width, and is suitable for displaying lyrics with chord names above, etc. “Proportional Small,” “Proportional Medium,” and “Proportional Large” are suitable for displaying lyrics without chord names or explanatory notes.

 **NOTE**

If the text is garbled or unreadable, you can probably remedy this by changing the System Language setting on the display called up via [MENU] → [Utility] → [System].

# Using the Auto Accompaniment Features with MIDI Song Playback

When playing back a MIDI Song and a Style at the same time, channels 9-16 in the Song data are replaced with Style channels—allowing you to play the accompaniment parts of the Song yourself. Try playing chords along with the Song playback as shown in the instructions below.

- 1** Select a Style.
- 2** Select a MIDI Song.
- 3** In the Song Player mode of the Song Playback display, touch  (Synchro Start) to enable synchronized start of the Song.

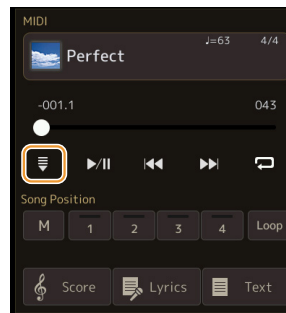

- 4** Press the [ACMP] button to turn on the auto accompaniment function, then press the STYLE CONTROL [SYNC START] button to enable synchronized start of the accompaniment.

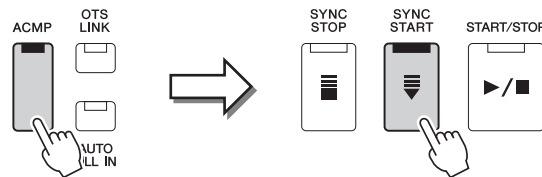

- 5** Press the STYLE CONTROL [START/STOP] button or play chords in the chord section.

The Song and Style starts playing. When you play chords, turning on “Chord” on the Score display ([page 60](#)) allows you to see the chord information.

When the Song playback is stopped, Style playback is also stopped at the same time.

## NOTE

When playing back a Song and a Style at the same time, the tempo value set in the Song is automatically used.

## NOTE

The Style Retrigger function ([page 119](#)) cannot be used during Song playback.

## Turning Each Channel of a MIDI Song On/Off

A MIDI Song consists of 16 separate channels. You can independently turn each channel of the selected Song playback on or off on the display called up via [MENU] → [Channel On/Off].

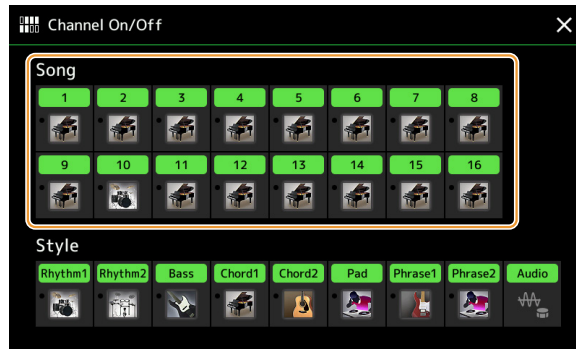

If you want to play back only one particular channel (solo playback), touch and hold the desired channel until it turns purple. To cancel solo, simply touch the (purple) channel again.

### NOTE

Usually, each part is recorded to the following channels.

- **Channels 1–4:** keyboard parts (Right 1, Left, Right 2, Right 3)
- **Channels 5–8:** Multi Pad parts
- **Channels 9–16:** Style parts

### NOTE

You can also turn the channels on/off on the Mixer display.

### To change the Voice for each channel:

Touch the instrument icon below the desired channel to call up the Voice Selection display, and then select the desired Voice.

# Song Playback Related Settings

You can make a variety of settings for Song Playback, on the display called up via [MENU] → [Song Setting].

 **NOTE**

The display can also be called up from [Menu] on the Song Player or the Song Selection display.

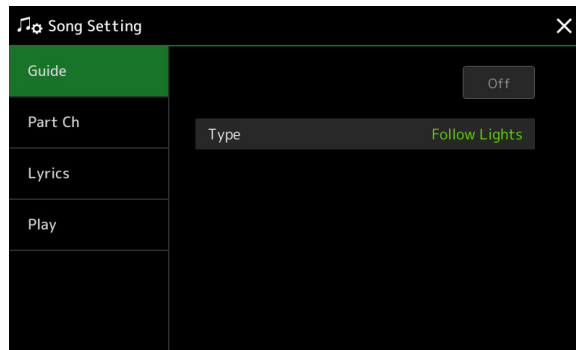

## Guide—Keyboard and Vocal Practice Using the Guide Function

With the Guide function, the instrument indicates the timing you need to play notes in the Score display for ease in learning. Also, when you sing along with a MIDI Song playback using a connected microphone, you can adjust the timing of the MIDI Song playback to match your vocal performance manually by using the keyboard.

- 1** Select a MIDI Song and call up the Score display (page 59).
- 2** Make Guide settings on the display called up via [MENU] → [Song Setting] → [Guide].

On/Off	Turn this on to use the Guide function. It can also be turned on/off from the “Play Setting” window of the Score display (page 59).
Type	<p>Determines the Guide type.</p> <p><b>Guide menu for keyboard practice</b></p> <ul style="list-style-type: none"> <li>• <b>Follow Lights:</b> When this is selected, Song playback pauses, waiting for you to play the notes correctly. When you play the correct notes, Song playback continues. Follow Lights was developed for the Yamaha Clavinova series. This function is used for practicing purposes, with built-in lamps on the keyboard indicating the notes to be played. Even though the PSR-SX900/SX700 does not have these lamps, you can use the same function by following the indications in the displayed notation with the Song Score function.</li> <li>• <b>Any Key:</b> With this function, you can play the melody of a Song just by pressing a single key (any key is OK) in time with the rhythm. Song playback pauses and waits for you to play any key. Simply play a key on the keyboard in time with the music and Song playback continues.</li> <li>• <b>Your Tempo:</b> The same as Follow Lights, except that Song playback matches the speed at which you play.</li> </ul> <p><b>Guide menu for singing</b></p> <ul style="list-style-type: none"> <li>• <b>Karao-Key:</b> This function lets you control the Song playback timing with just one finger, while you sing along. This is useful for singing to your own performance. Song playback pauses, waiting for you to sing. Simply play any key on the keyboard (playing the keyboard produces no sound) and Song playback continues.</li> </ul>

**3** Return to the Score display by pressing the [EXIT] button repeatedly, if necessary.

**4** Press the SONG MIDI [▶/||] (PLAY/PAUSE) button to start playback.

Practice playing the keyboard or singing along with the Guide type selected in step 2.

**5** Play the keyboard along with Song playback.

 **NOTE**

The Guide settings can be saved as a part of Song data (page 73). When you select the saved Song the next time, the corresponding Guide settings will also be called up.

## Part Ch

Right	Determines which channel is assigned to the right-hand part.
Left	Determines which channel is assigned to the left-hand part.
Auto Set	When set to “On,” this automatically sets the proper MIDI channels for the right- and left hand parts pre-programmed in the commercially available Song data. Normally, this should be set to “On.”

## Lyrics

Language	Determines the language of the displayed lyrics. <ul style="list-style-type: none"><li>• <b>Auto:</b> When the language is specified in the Song data, the lyrics are displayed accordingly. When the language is not specified in the Song data, the lyrics language is regarded as “International” below.</li><li>• <b>International:</b> Handles the displayed lyrics as a western language.</li><li>• <b>Japanese:</b> Handles the displayed lyrics as Japanese.</li></ul>
----------	--

## Play

Phrase Mark Repeat	Phrase Mark is a pre-programmed part of some Song data, which specifies a certain location (set of measures) in the Song. When this is “On,” the section corresponding to the specified Phrase Mark number is repeatedly played back. This parameter is available only when the MIDI Song containing Phrase Mark settings is selected.
Quick Start	On some commercially available MIDI Song data, certain settings related to the MIDI Song (such as Voice selection, volume, etc.) are recorded to the first measure, before the actual note data. When Quick Start is set to “On,” the instrument reads all initial non-note data of the Song at the highest possible speed, then automatically switches to the appropriate tempo at the first note. This allows you to start playback as quickly as possible, with a minimum pause for reading of data.
Song Previous Type	Determines the behavior when pressing the SONG [I◀◀] (PREV) buttons. <ul style="list-style-type: none"><li>• <b>Previous Song:</b> When the playback position is near the Song top, this moves to the previous Song in the same folder. In other cases, this returns the playback position to the Song top.</li><li>• <b>Song Top Only:</b> Only returns the playback position to the Song top, and does not move to the previous Song.</li></ul>
MIDI Song Fast Forward Type	Determines the fast forward type used when pressing [NEXT] (▶▶) during MIDI Song playback. <ul style="list-style-type: none"><li>• <b>Jump:</b> Pressing [NEXT] (▶▶) once instantly sets the playback position to the next measure without sounding. Holding [NEXT] (▶▶) scrolls forward continuously.</li><li>• <b>Scrub:</b> Pressing and holding [NEXT] (▶▶) plays and sounds the MIDI Song at high speed.</li></ul>
Style Synchro Stop	Determines whether or not playback of a Style stops when MIDI Song playback is stopped.
Multi Pad Synchro Stop	Determines whether or not the repeat playback of a Multi Pad stops when MIDI Song playback is stopped.

## Contents

Overview of MIDI Song Recording .....	67
Recording Each Channel Individually (Realtime Recording) .....	69
Re-recording a Specific Section—Punch In/Out (Realtime Recording).....	71
Recording Panel Setups to a Song.....	73
Editing Channel Events of Existing Song Data .....	74
• Function Details .....	75
Step Recording/Editing Songs (Step Edit) .....	77
• Basic Procedure for Step Recording/Editing .....	77
• Recording Melodies via Step Recording .....	78
• Recording Chord/Section Change Events via Step Recording .....	81
• Editing Specific MIDI Events of the Recorded Data.....	83
• Editing Song Position Markers .....	85

## Overview of MIDI Song Recording

The Owner's Manual covers how to create an original MIDI Song by recording your keyboard performance without specifying channels (called "Quick Recording"). This Reference Manual shows how to create an original Song by recording your keyboard performance to a specified channel or by entering notes one by one (called "Multi Recording") and how to improve an already created Song by editing the detailed parameters.

### ■ Realtime Recording and Step Recording

When creating a MIDI Song, these two Recording methods are available. With Realtime Recording, this instrument records the performance data as it is played. With Step Recording, you can compose your performance by "writing" it down one event at a time.

### ■ MIDI Song Data Structure

A MIDI Song consists of 16 MIDI channels. You can create data of a MIDI Song by recording your performance to a specific channel or channels in realtime, or by executing Step Recording.

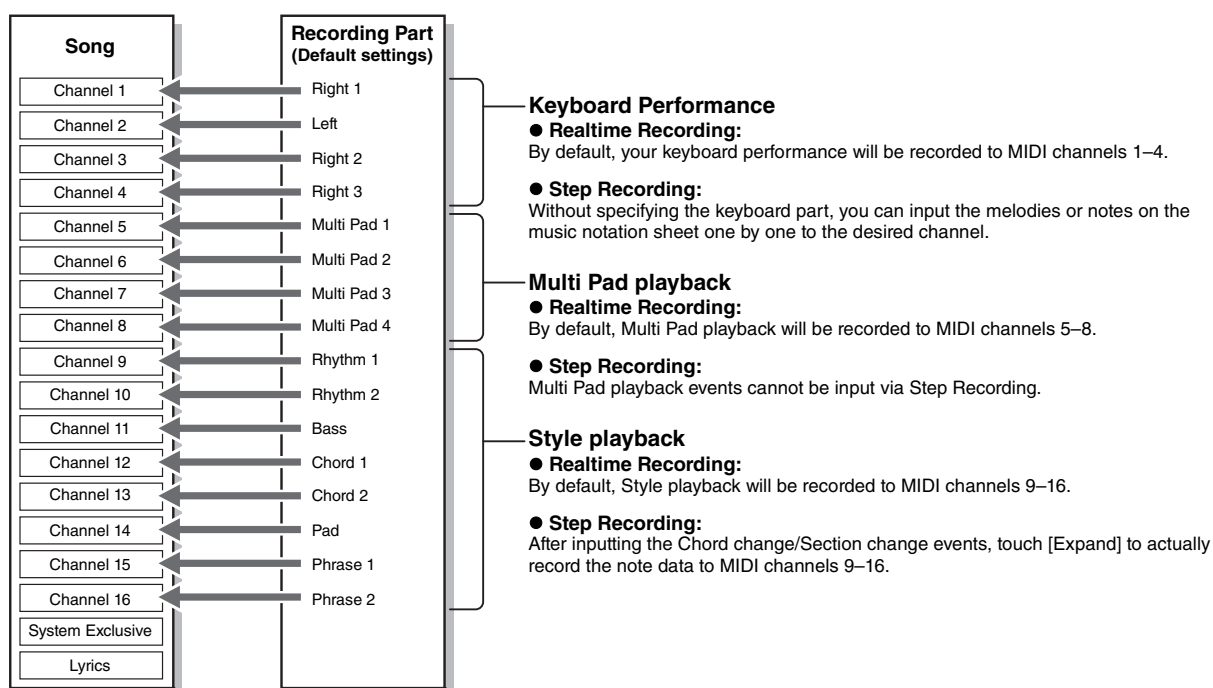

**NOTE**

Audio data such as the rhythm channels created via the audio data of Audio Link Multi Pad and Audio Songs cannot be recorded to the MIDI Songs.

**■ MIDI Multi Recording Display Structure**

The MIDI Multi Recording display is the portal display for Multi Recording and can be called up via [RECORDING] → MIDI [Multi Recording].



①	Save	For saving the edited Song.
②	Step Edit	For creating or editing a Song via Step Recording. For details, see <a href="#">page 77</a> .
③	Setup	For selecting the panel setups to be recorded to the top position of the Song. For details, see <a href="#">page 73</a> .
④	New	For calling up a blank Song.
⑤	Menu	For calling up the Mixer display or setting the playback volume of the currently recorded Song for adjusting the balance when recording other channels.
⑥	Song name	Indicates the current Song name. Touching this calls up the Song Selection display for selecting a MIDI Song.
⑦	Bar. Beat	Indicates the current measure number and the beat.
⑧	Rec Mode	Indicates the Recording Mode ( <a href="#">page 71</a> ), which can be set from the display called up by touching here.
⑨	Metronome	For turning the metronome on/off.
⑩	Channels	For specifying the channels to be edited.
⑪	Song Control	For controlling Song playback or recording.
⑫	Functions	For editing channel events. For details, see <a href="#">page 74</a> .

**NOTE**

- The MIDI Multi Recording display can also be called up via [MENU] → [Song Recording] → MIDI [Multi Recording].
- Entering the Recording mode resets the MIDI Song selection in the Song Playback display and a MIDI Song cannot be selected.
- The Style Retrigger function ([page 119](#)) cannot be used when you are overdubbing to existing data.



# Recording Each Channel Individually (Realtime Recording)

With MIDI Recording, you can create a MIDI Song consisting of 16 channels by recording your performance to each channel one by one. In recording a piano piece, for example, you can record the right-hand part to channel 1 and then record the left-hand part to channel 2, allowing you create a complete piece which may be difficult to play live with both hands together. To record a performance with Style playback, for example, record the Style playback to channels 9–16, then record melodies to channel 1 while listening to the already recorded Style playback. In this way, you can create an entire Song which would otherwise be difficult, or even impossible, to play live.

## 1 Call up the MIDI Multi Recording display via [RECORDING] → MIDI [Multi Recording].

A blank Song for recording is automatically set, and the Song name on the Multi Recording display is set to “New Song.”



## 2 If you want to re-record an existing Song, select the desired Song by touching the Song name, and then press the [EXIT] button to return to the Multi Recording display.

If you want to record from scratch, skip this step.

## 3 Touch the instrument icon of the target channel to call up the part setting window, and then specify the part for recording.

Touching [OK] automatically turns [Rec] on of the target channel, and sets it to recording standby status.

### NOTICE

Previously recorded data will be overwritten if you set [Rec] to on for those channels which already have recorded data.

### NOTE

If you want to cancel recording, touch [●] (Rec) in the display before going on to step 4, then press the [EXIT] button to exit from the Recording mode.

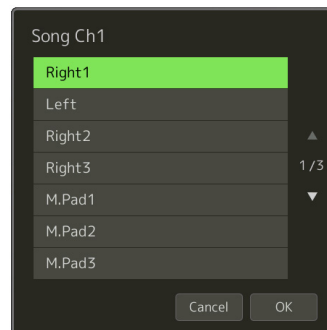

If you want to turn the other channels on or off while recording, touch the channel number of the desired channel.

#### 4 Play the keyboard to start recording.

You can also start recording by touching [●] (Rec) or [▶/||] (Play/Pause).

When recording to the Song which has recorded data, you can turn already recorded channels on or off by touching the channel number.



#### 5 After you finish your performance, touch [■] (Stop) to stop recording.

#### 6 To hear the recorded performance, touch [▶/||] (Play/Pause).

#### 7 Record your performance to another Channel by repeating steps 3–6.

#### 8 Touch (Save) to save the recorded performance.

#### **NOTICE**

The recorded Song will be lost if you change to another Song or you turn the power off without carrying out the Save operation.

## Re-recording a Specific Section—Punch In/Out (Realtime Recording)

When re-recording a specific section of an already-recorded MIDI Song, use the Punch In/Out function. In this method, only the data between the Punch In point and the Punch Out point is overwritten with the newly recorded data. Keep in mind that the notes before and after the Punch In/Out points are not recorded over, and you will hear them play back normally to guide you in the Punch In/Out timing.

- 1 On the MIDI Multi Recording display, select a Song to be re-recorded, and then press the [EXIT] button to return to the Multi Recording display.



- 2 Touch [Start/Stop] to call up the operation display.
- 3 Set various parameters, such as how the Recording starts/stops and the Punch In/Out position.

### NOTE

The parameters here cannot be set while recording.

Rec Start	<p>Determines the recording start behavior.</p> <ul style="list-style-type: none"> <li>• <b>Normal:</b> Overwrite recording starts when Song playback is started via the [▶/  ] (Play/Pause) on the MIDI Multi Recording display or when you play the keyboard in the Synchro Standby mode.</li> <li>• <b>First Key On:</b> The Song plays back normally, then starts overwrite recording as soon as you play the keyboard.</li> <li>• <b>Punch In At:</b> The Song plays back normally up to the beginning of the beginning of the “Bar” (measure) specified here, then starts overwrite recording at that point.</li> </ul>
Rec Stop	<p>Determines the recording stop behavior, or how data is handled after recording is stopped.</p> <ul style="list-style-type: none"> <li>• <b>Replace All:</b> This deletes all data after the point at which recording is stopped.</li> <li>• <b>Punch Out:</b> The Song position at which recording is stopped is regarded as the Punch Out point. This setting maintains all data after the point at which recording is stopped.</li> <li>• <b>Punch Out At:</b> Actual overwrite recording continues until the beginning of the “Bar” (measure) specified here, at which point recording stops and normal playback continues. This setting maintains all data after the point at which recording is stopped.</li> </ul>
Pedal Punch In/Out	<p>When this is set to “On,” you can use Foot Pedal 2 to control the Punch In and Punch Out points. While a Song is playing back, pressing (and holding) Foot Pedal 2 instantly enables Punch In recording, while releasing the pedal stops recording (Punch Out). You can press and release Foot Pedal 2 as often as you want during playback. Note that the current function assignment of the center pedal is cancelled when the Pedal Punch In/Out function is set to “On.”</p> <p><b>NOTE</b> Pedal Punch In/Out operation may be reversed depending on the particular pedal you’ve connected to the instrument. To remedy this, try changing the pedal polarity (page 111).</p>

**4** On the MIDI Multi Recording display, touch [Rec] corresponding to the desired channel for re-recording to turn it on.

**5** Touch [▶/II] (Play/Pause) to start recording.

At the Punch In point specified in step 3, play the keyboard to start actual recording. At the Punch Out point specified in step 3, stop playing the keyboard.

**6** Touch  (Save) to save the recorded performance.

**NOTICE**

The recorded Song data will be lost if you select another Song or turn the power to the instrument off without carrying out the Save operation.

**Examples of re-recording with various Punch In/Out settings**

This instrument features several different ways you use the Punch In/Out function. The illustrations below indicate a variety of situations in which selected measures in an eight-measure phrase are re-recorded.

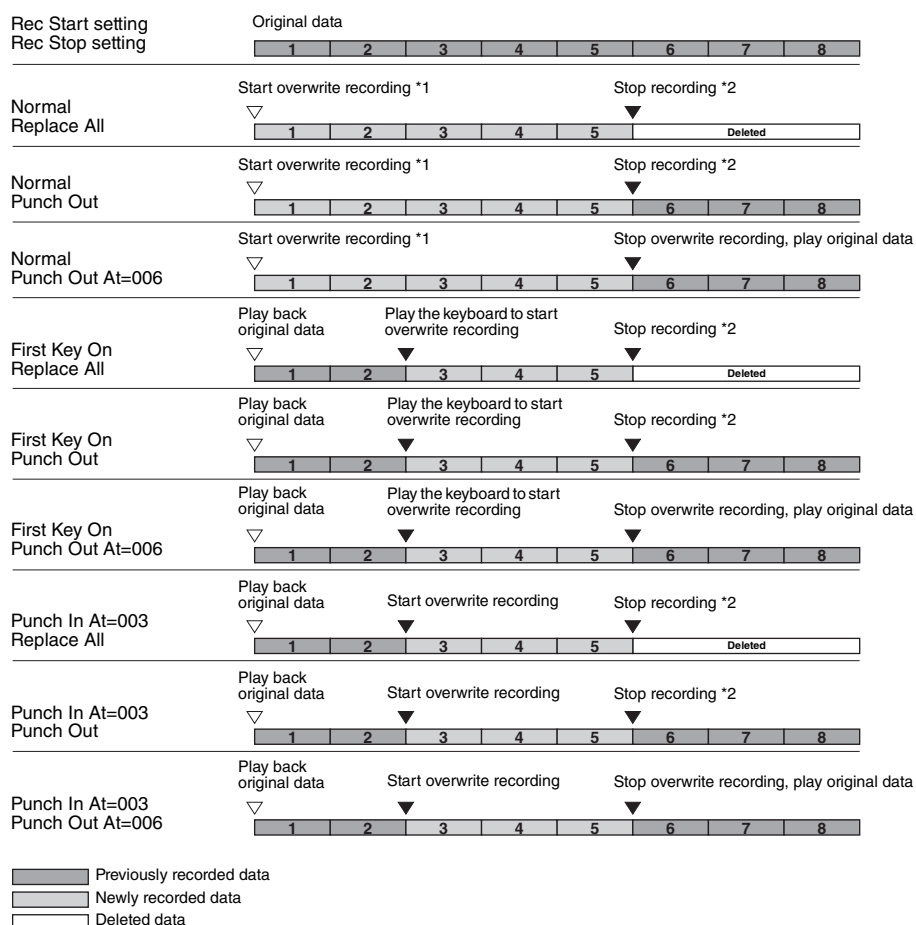

## Recording Panel Setups to a Song

The current settings of the Mixer display and other panel settings can be recorded to the top position of the Song as the Setup data. The Mixer and panel settings recorded here are automatically recalled when the Song starts.

- 1 On the MIDI Multi Recording display, select a Song for recording the Setup data, and then press the [EXIT] button to return to the Multi Recording display.



- 2 Touch [■] (Stop) to move the Song position to the top of the Song.
- 3 Touch  (Setup) to call up the Setup window.
- 4 Checkmark the items of playback features and functions that you wish to automatically be called up along with the selected Song.

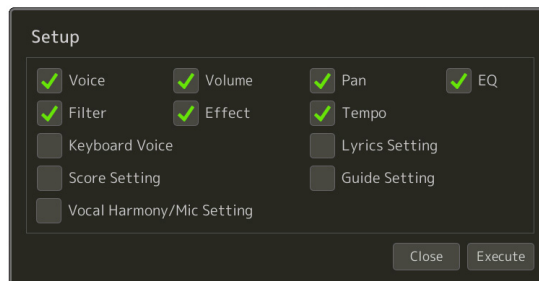

- 5 Touch [Execute] to record the data, and then touch [Close].
- 6 Touch  (Save) to carry out the Save operation.

### NOTICE

The edited Song data will be lost if you select another Song or turn off the power to the instrument without carrying out the Save operation.

## Editing Channel Events of Existing Song Data

The functions shown at the bottom right of the MIDI Multi Recording let you correct or convert a specific channel of the existing Song data.

- 1** On the MIDI Multi Recording display, select a Song to be edited, and then press the [EXIT] button to return to the Multi Recording display.



- 2** Touch the desired function and edit the parameters.

To exit from the function and select another function, touch the function again.  
For details of the functions and available settings, see [page 75](#).

- 3** Touch [Execute] for the current function to actually enter the edits.

When execution is completed, this button changes to [Undo], letting you restore the original data if you are not satisfied with the results. The Undo function only has one level; only the previous operation can be undone.

- 4** Touch  (Save) to carry out the Save operation.

### NOTICE

The edited Song data will be lost if you select another Song or turn the power to the instrument off without carrying out the Save operation.

# Function Details

## Quantize

The Quantize function allows you to align the timing of all the notes in a channel. For example, if you record the musical phrase shown below, you may not play it with absolute precision, and your performance may have been slightly ahead of or behind the precise timing. Quantize is a convenient way of correcting for this.



Touch the [Select] below the instrument icon for the channel to be quantized, and then edit the parameters.

<p>Size</p>	<p>Selects the quantize size (resolution). For optimum results, you should set the Quantize size to the shortest note value in the channel. For example, if eighth notes are the shortest in the channel, you should use eighth note as the Quantize size.</p> <p><b>Settings:</b></p> <p>  1/4 note            1/8 note            1/16 note            1/32 note            1/16 note+ 1/8 note triplet*   1/4 note triplet            1/8 note triplet            1/16 note triplet            1/8 note+ 1/8 note triplet*            1/16 note+ 1/16 note triplet*     </p> <p>The three Quantize settings marked with asterisks (*) are exceptionally convenient, since they allow you to quantize two different note values at the same time. For example, when the straight eighth notes and eighth notes triplet are contained in the same channel, if you quantize by the straight eighth notes, all notes in the channel are quantized to straight eighth notes—completely eliminating any triplet feel. However, if you use the eighth note + eighth note triplet setting, both the straight and triplet notes will be quantized correctly.</p>
<p>Strength</p>	<p>Determines how strongly the notes will be quantized. A setting of 100% produces exact timing. If a value less than 100% is selected, notes will be moved toward the specified quantization beats according to the specified percentage. Applying less than 100% quantization lets you preserve some of the “human” feel in the recording.</p>

## Delete

You can delete the data of the specified channel in the Song. Touch [Delete] and turn it on for the desired channel whose data you wish to delete, and then touch [Execute] to actually delete the data.

## Mix

This function lets you mix the data of two channels and place the results in a different channel. Touch one of the menu items below, and then touch the instrument icon or the box below for the desired channel.

Source 1	Determines the MIDI channel (1–16) to be mixed. All MIDI events of the channel specified here are copied to the destination channel.
Source 2	Determines the MIDI channel (1–16) to be mixed. Only note events of the channel specified here are copied to the destination channel.
Destination	Determines the channel into which the mix results will be placed.

## Copy

This function lets you copy the data from one channel to another. Touch one of the menu items below, and then touch the instrument icon or the box below for the desired channel.

Source	Determines the MIDI channel (1–16) to be copied. All MIDI events of the channel specified here are copied to the destination channel.
Destination	Determines the channel into which the copy results will be placed.

## Transpose

This allows you to transpose the recorded data of individual channels up or down by a maximum of two octaves in semitone increments. Touch the box below the instrument icon for the channel to be transposed, then edit the value. If you want to transpose all channels simultaneously, use the menu below.

All +	Increases the Transpose value for all channels by 1.
All -	Decreases the Transpose value for all channels by 1.

### NOTE

Make sure not to transpose channels 9 and 10. In general, Drum kits are assigned to these channels. If you transpose the channels of Drum kits, the instruments assigned to each key will be changed.

### NOTE

If you want to listen to the data as currently edited, play it back before touching [Execute]. Touching [Execute] transposes the pitch, and also resets the value to 0 allowing you to further transpose, if necessary.



# Step Recording/Editing Songs (Step Edit)

This section shows how to create a new Song or edit an existing Song with the Step Edit feature.

## Basic Procedure for Step Recording/Editing

This section covers the basic procedure for Step Recording.

### 1 Call up the MIDI Multi Recording display via [RECORDING] → MIDI [Multi Recording].

A blank Song for recording is automatically set, and the Song name on the Multi Recording display is set to “NewSong.” If you want to re-record an existing Song, select the desired Song by touching the Song name.

### 2 Touch (Step Edit) at the top of this display to call up the Step Edit display.

#### NOTE

To return to the MIDI Multi Recording display, touch [StepEdit] on the Step Edit display.

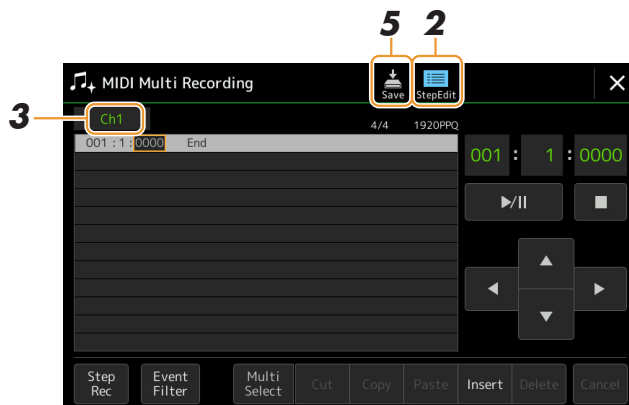

### 3 Touch [Ch1] at the top left of this display to select the Recording Target channel.

- If you want to record the keyboard performance, select one of “Ch1”–“Ch8.” If you do not intend to use Style playback for the Song, “Ch9”–“Ch16” can be selected.
- If you want to edit the System Exclusive data, select “SysEx.”
- If you want to edit Lyrics, select “Lyrics.”
- If you want to record Style playback (Chord change and Section change events), select “Chord.”

### 4 According to your selection in step 3, carry out Step Recording or data edits.

- **When one of “Ch1”–“Ch16” is selected:**

For instructions on editing already recorded data, refer to [page 83](#).

For instructions on inputting melodies via Step Recording, touch [Step Rec] at the bottom left of the display then refer to [page 78](#).

- **When “SysEx” is selected:**

Edit the already recorded data, following the explanations on [page 83](#). Step Recording is not available.

- **When “Lyrics” is selected:**

Edit the already recorded data, following the explanations on [page 83](#). Step Recording is not available.

- **When “Chord” is selected:**

For instructions on editing already recorded data, refer to [page 83](#).

For instructions on inputting Chord/Section Change events for Style playback via Step Recording, touch [Step Rec] then refer to [page 81](#).

### 5 Touch (Save) to save the created Song.

#### NOTICE

The created Song data will be lost if you select another Song or turn off the power to the instrument without carrying out the Save operation.

## Recording Melodies via Step Recording

The explanations here apply when one of “Ch1”–“Ch16” is selected in step 4 on [page 77](#). With [Step Rec] turned on at the bottom left of the display, you can input the notes one by one, using the controls below.

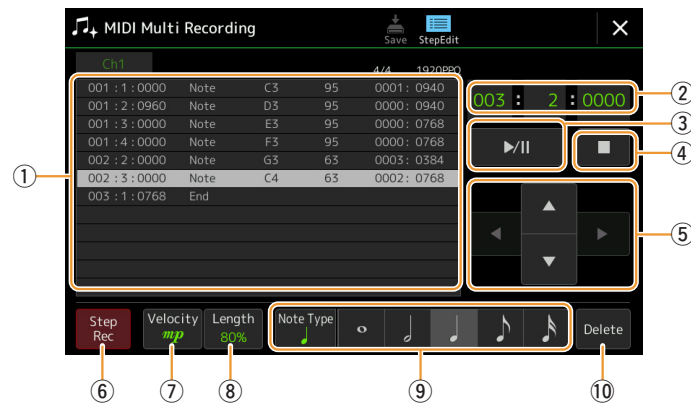

### Control Names and Functions

①	Event List	Indicates events such as note and Voice selection which have been input. For details, refer to <a href="#">page 83</a> .
②	Song Position (Measure: Beat: Clock)	Indicates the current Song position. Events such as note and Voice selection you have input are recorded at the position indicated here. You can change the current position (Measure: Beat: Clock*) by using the Data dial. * Clock: Smallest unit for the Song position and note length. A quarter note consists of 1920 clocks.
③	▶/   (Play/Pause)	Plays back or pauses the current Song.
④	■ (Stop)	Stops the current Song to return to the top of the Song.
⑤	Cursor	Lets you move the cursor position.
⑥	Step Rec	Turning this on shows the Step Recording display, and turning it off shows the Step Edit display.
⑦	Velocity	Determines the velocity (loudness) of the note to be entered. The velocity value can be specified within a range from 1 to 127. The higher the velocity value, the louder the sound becomes.  <ul style="list-style-type: none"> <li>• <b>Kbd.Vel:</b> Actual resulting velocity</li> <li>• <b><i>fff</i></b> : 127</li> <li>• <b><i>ff</i></b> : 111</li> <li>• <b><i>f</i></b> : 95</li> <li>• <b><i>mf</i></b> : 79</li> <li>• <b><i>mp</i></b> : 63</li> <li>• <b><i>p</i></b> : 47</li> <li>• <b><i>pp</i></b> : 31</li> <li>• <b><i>ppp</i></b>: 15</li> </ul>
⑧	Length	Determines the gate time (note length) of the note to be entered. <b>Tenuto</b> : ██████████ 99% <b>Normal</b> : ████████ 80% <b>Staccato</b> : ██████ 40% <b>Staccatissimo</b> : █████ 20% <b>Manual:</b> For freely setting the gate time. Touch “Manual” and close the pop-up window by touching “OK,” and then set the gate time to any desired percentage by using the Data dial.
⑨	Note Type, Note Indication	Touching [Note Type] repeatedly will alternate among the types of note indications at right in order: normal, dotted, and triplet. Select one of three types, then select (turn on) one of the note indications with which the next note is input. If you touch the selected note indication (which is turned on) again, a rest will be input with the corresponding length.
⑩	Delete	Deletes the selected data.

## Example of Step Recording—Melodies

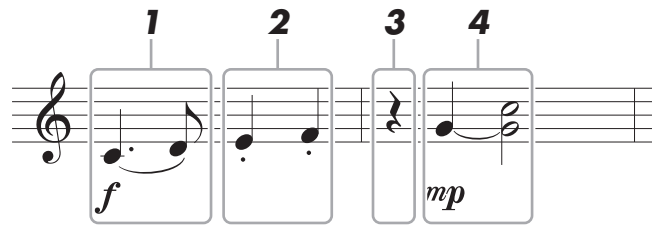

\* The numbers shown in the illustration correspond to the following operation step numbers.

### NOTE

The illustration given here is just a sample. Since the music score (called up via [MENU] → [Score]) is generated from recorded MIDI data, it may not appear exactly the same as shown above. Non-note musical performance symbols will not be shown in the Score display, even if you've entered them.

This section describes the instructions on inputting the melodies of the above notation via the Step Recording. Before starting, note the following points:

- To input the note with the tie in step 4, you need to operate without releasing the key. Proceed with the operations, reading the instructions carefully.
- Before inputting notes as described below, select the desired Voice by pressing one of the VOICE category selection buttons to call up the Voice Selection display. Even if it has already been selected, you need to re-select the same Voice to input the Voice number to the Event List. Keep in mind that only note and Voice selection events can be input with Step Recording.

## 1 Enter the first and second notes with a slur.

- 1-1** Touch [Velocity] to select “*f*.”
- 1-2** Touch [Length] to select “99% (Tenuto).”
- 1-3** Touch [Note Type] once or twice to call up the dotted note type.
- 1-4** Touch the dotted quarter-note length (♩.) to turn it on.
- 1-5** Press the C3 key.

With the operations above, the first note has been entered. Next, enter the second note.

- 1-6** Touch [Note Type] once or twice to call up the normal note indications.
- 1-7** Touch the eighth-note length (♪) to turn it on.
- 1-8** Press the D3 key.

The first and second notes are entered with a slur.

## 2 Enter the next notes with staccato.

- 2-1** Touch [Length] to select “40% (Staccato).”
- 2-2** Touch the quarter-note length (♩) to turn it on.
- 2-3** Play the keys E3 and F3 in order.

The first measure has been completed.

 NEXT PAGE

### **3 Enter a quarter-note rest.**

Touch the quarter-note (♩), that has been turned on, just once to input a quarter-note rest.

Be careful not to touch the same note (which is turned on) several times. Doing so results in multiple rests being input for the corresponding times. Rests are not actually indicated as such in the Event List, but you can confirm whether any have been input or not by checking the Song Position.

### **4 Enter the next notes and apply a tie.**

**4-1** Touch [Velocity] to select “*mp*.”

**4-2** Touch [Length] to select “80% (Normal).”

**4-3** While holding G3 key on the keyboard, touch quarter-note (♩).

Do not release the G3 key yet. Keep holding it while executing the following steps.

**4-4** While holding the G3 key, press the C4 key.

Do not release the G3 and C4 keys yet. Keep holding the notes while executing the following step.

**4-5** While holding the keys G3 and C4, touch half-note (♪).

After touching half-note (♪), release the keys.

The second measure has been completed.

### **5 Touch [■] (Stop) to return to the top of the Song, then listen to the newly entered Song by touching [▶/II] (Play/Pause).**

# Recording Chord/Section Change Events via Step Recording

The explanations here apply when “Chord” is selected in step 4 on [page 77](#). With [Step Rec] turned on at the bottom left of the display, you can input the Chord/Section Change events for Style playback one by one.

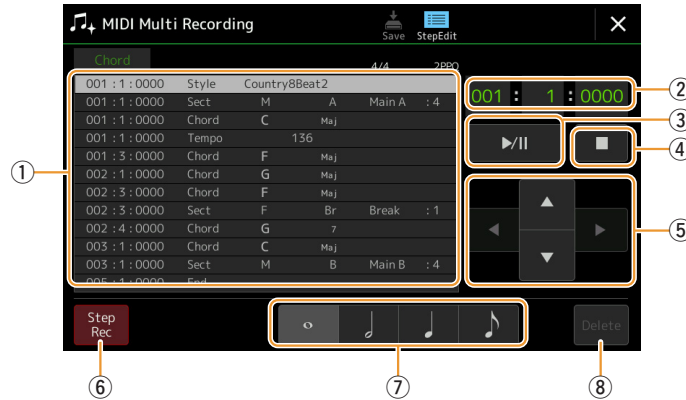

**NOTE**

(PSR-SX900) The Audio part of an Audio Style cannot be recorded.

## Control Names and Functions

①	Event List	Indicates events such as Chord and Section changes which have been input. For details, refer to <a href="#">page 83</a> .
②	Song Position (Measure: Beat: Clock)	Indicates the current Song position. Events such as Chord and Section change you have input are recorded at the position indicated here. You can change the current position (Measure: Beat: Clock*) by using the Data dial. * Clock: Smallest unit for the Song position and note length. A quarter note consists of 1920 clocks.
③	▶/   (Play/Pause)	Plays back or pauses the current Song.
④	■ (Stop)	Stops the current Song to return to the top of the Song.
⑤	Cursor	Lets you move the cursor position.
⑥	Step Rec	Turning this on shows the Step Recording display, and turning it off shows the Step Edit display.
⑦	Note Indications	Select one of the four note lengths for inputting the next event.
⑧	Delete	Deletes the selected data.

## Example of Step Recording—Chord/Section Events

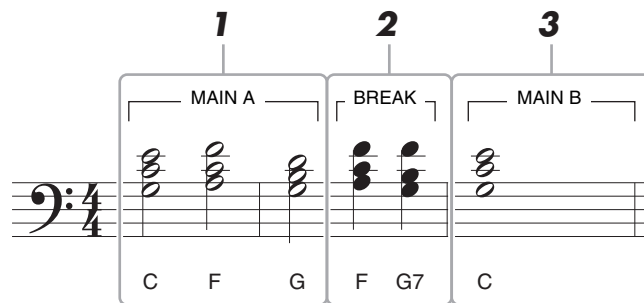

\* The numbers shown in the illustration correspond to the following operation step numbers.

These instructions show how to input the Chord/Section change events of the above notation via Step Recording.

Before starting, note the following points:

- Turn off the STYLE CONTROL [AUTO FILL IN] button on the panel.
- Select a conventional 4-beat Style.

## 1 Enter the chords for the Main A section.

**1-1** Press the MAIN VARIATION [A] button.

**1-2** Touch the half-note length (♩) to turn it on.

**1-3** Play the chords C, F and G in the chord section of the keyboard.

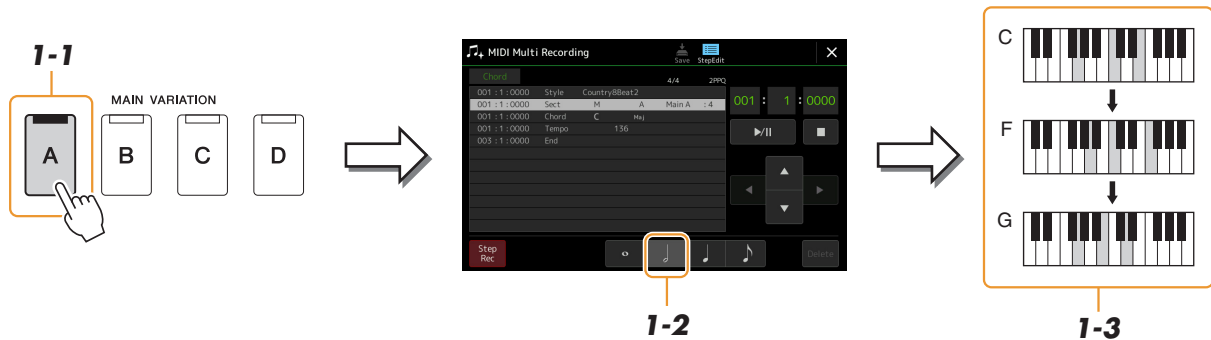

## 2 Enter the chords for the Break section.

**2-1** Press the [BREAK] button.

**2-2** Touch the quarter-note length (♩) to turn it on.

**2-3** Play the chords F and G7 in the chord section of the keyboard.

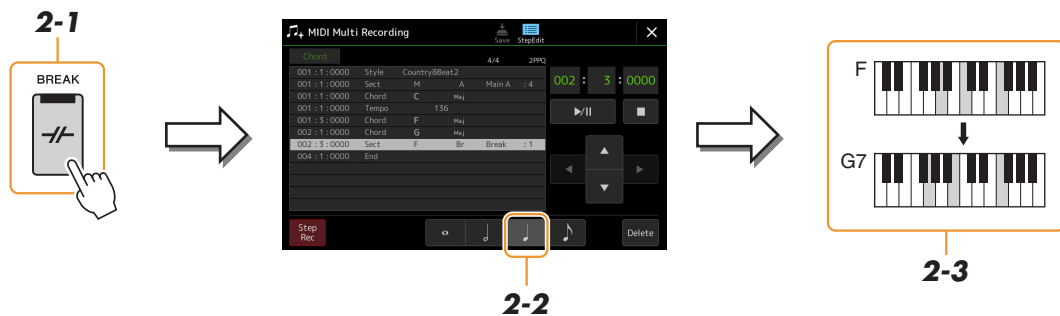

### NOTE

To enter fill-ins, turn the [AUTO FILL IN] button to on, and simply press the desired MAIN VARIATION [A]–[D] button.

## 3 Enter the chords for the Main B section.

**3-1** Press the MAIN VARIATION [B] button.

**3-2** Touch the whole-note length (♩) to turn it on.

**3-3** Play the chord C in the chord section of the keyboard.

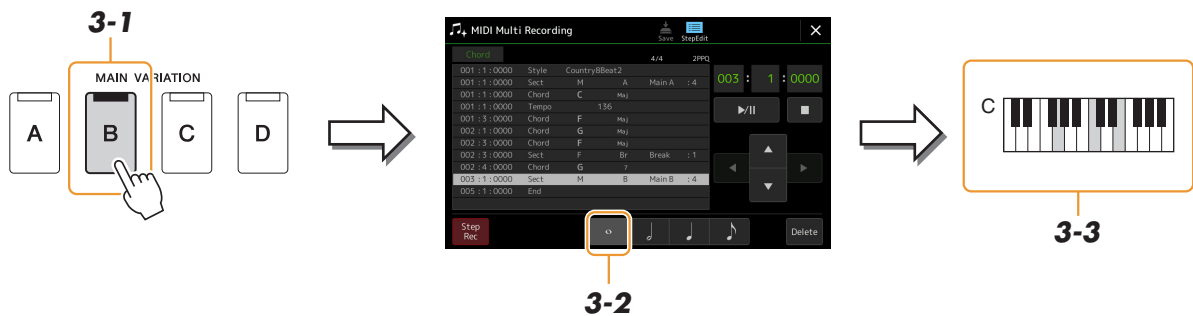

The Chord and Section change events are now entered.

**4** Touch [■] (Stop) to return to the top of the Song, then listen to the newly entered Song by touching [▶/II] (Play/Pause).

**5** Touch and turn off [Step Rec] to call up the Step Edit display.

**6** Touch [Expand] at the upper left of the Step Edit display to convert the Chord/Section change events to Song data.



With the operations above (steps 1–3), only Chord and Section change events are recorded, meaning that the actual Song data has not been created and the Style part can produce no sound even if you start Song playback after exiting from the MIDI Multi Recording display. Accordingly, make sure to execute the Expand function after you finish inputting. If you have not finished inputting, save the Song to maintain the recorded events then continue inputting additional events as desired in the future.

# Editing Specific MIDI Events of the Recorded Data

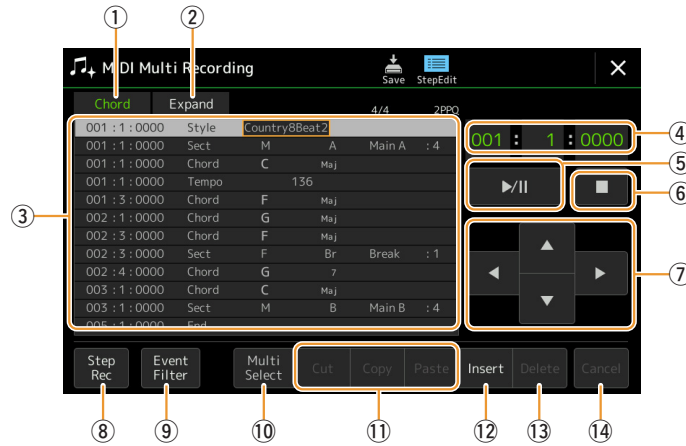
The explanations here apply to step 4 on page 77. From the Step Edit display, you can edit specific MIDI events, such as Note data and Voice selection, which have been created via Realtime Recording or Step Recording.



①	Editing Target	<p>Specifies the Editing Target.</p> <ul style="list-style-type: none"> <li>• <b>Ch 1–Ch 16:</b> When one of these is selected, you can edit the channel data.</li> <li>• <b>SysEx:</b> For editing System Exclusive data (applies to all channels).</li> <li>• <b>Lyrics:</b> For editing Lyrics data.</li> <li>• <b>Chord:</b> For editing Chord/Section change events for Style playback.</li> </ul>																								
②	Expand	<p>This is shown only when “Chord” is selected above, and lets you convert the Chord/Section change events you input in the Step Recording display to actual sounded note data. Make sure to execute this function when finalizing Song data. If you exit from the MIDI Multi Recording display without executing this function, starting Song playback produces no sound of the Style part.</p>																								
③	Event List	<p>In this area, the events of the Song data are listed and can be edited. Each line shows one event. Each event can be selected by using the Cursor buttons (⑦) on the display, and can be edited by using the Data dial.</p> <div data-bbox="667 1240 1246 1357" style="border: 1px solid black; padding: 5px; margin: 10px 0;"> <table border="1"> <tr> <td>001 : 1 : 0000</td> <td>Style</td> <td>Country8Beat2</td> </tr> <tr> <td>001 : 1 : 0000</td> <td>Sect</td> <td>M A Main A : 4</td> </tr> <tr> <td>001 : 1 : 0000</td> <td>Chord</td> <td>C Maj</td> </tr> <tr> <td>001 : 1 : 0000</td> <td>Tempo</td> <td>136</td> </tr> </table> </div> <p style="margin-left: 40px;"> <span style="margin-right: 100px;">Indicates the Song position (measure: beat: clock) of the corresponding event.</span> <span style="margin-right: 100px;">Indicates the event type.</span> <span>Indicates the event value or detail.</span> </p> <p>Depending on the Editing Target above (①), the listed and editable events differ as described below.</p> <div style="background-color: #f0f0f0; padding: 5px; margin: 10px 0;"> <p>● <b>When the Editing Target is set to one of “Ch1”–“Ch16”:</b></p> </div> <table border="1" style="width: 100%; border-collapse: collapse;"> <tr> <td style="width: 20%;">Note</td> <td>An individual note within a Song. Includes the note name which corresponds to the key which was played, plus a velocity value based on how hard the key is played, and the gate time value (the length of a note).</td> </tr> <tr> <td>Ctrl (Control Change)</td> <td>Settings to control the Voice, such as volume, pan, filter and effect depth (edited via the Mixer), etc.</td> </tr> <tr> <td>Prog (Program Change)</td> <td>MIDI program change number for selecting a Voice.</td> </tr> <tr> <td>P.Bnd (Pitch Bend)</td> <td>Data for changing the pitch of a Voice continuously.</td> </tr> <tr> <td>A.T. (After Touch)</td> <td>This event is generated when pressure is applied to a key after the note is played. Note that the keyboard of this instrument does not feature Aftertouch.</td> </tr> </table> <div style="background-color: #f0f0f0; padding: 5px; margin: 10px 0;"> <p>● <b>When the Editing Target is set to “SysEx”:</b></p> </div> <table border="1" style="width: 100%; border-collapse: collapse;"> <tr> <td style="width: 20%;">ScBar (Score Start Bar)</td> <td>Determines the top measure number as the starting point of the Song data.</td> </tr> </table>	001 : 1 : 0000	Style	Country8Beat2	001 : 1 : 0000	Sect	M A Main A : 4	001 : 1 : 0000	Chord	C Maj	001 : 1 : 0000	Tempo	136	Note	An individual note within a Song. Includes the note name which corresponds to the key which was played, plus a velocity value based on how hard the key is played, and the gate time value (the length of a note).	Ctrl (Control Change)	Settings to control the Voice, such as volume, pan, filter and effect depth (edited via the Mixer), etc.	Prog (Program Change)	MIDI program change number for selecting a Voice.	P.Bnd (Pitch Bend)	Data for changing the pitch of a Voice continuously.	A.T. (After Touch)	This event is generated when pressure is applied to a key after the note is played. Note that the keyboard of this instrument does not feature Aftertouch.	ScBar (Score Start Bar)	Determines the top measure number as the starting point of the Song data.
001 : 1 : 0000	Style	Country8Beat2																								
001 : 1 : 0000	Sect	M A Main A : 4																								
001 : 1 : 0000	Chord	C Maj																								
001 : 1 : 0000	Tempo	136																								
Note	An individual note within a Song. Includes the note name which corresponds to the key which was played, plus a velocity value based on how hard the key is played, and the gate time value (the length of a note).																									
Ctrl (Control Change)	Settings to control the Voice, such as volume, pan, filter and effect depth (edited via the Mixer), etc.																									
Prog (Program Change)	MIDI program change number for selecting a Voice.																									
P.Bnd (Pitch Bend)	Data for changing the pitch of a Voice continuously.																									
A.T. (After Touch)	This event is generated when pressure is applied to a key after the note is played. Note that the keyboard of this instrument does not feature Aftertouch.																									
ScBar (Score Start Bar)	Determines the top measure number as the starting point of the Song data.																									

	Tempo	Determines the tempo value.
	Time (Time signature)	Determines the time signature.
	Key (Key signature)	Determines the key signature, as well as the major/minor setting, for the music score shown on the display.
	XGPrm (XG parameters)	Allows you to make various detailed changes to the XG parameters. Refer to the Data List (MIDI Data Format) on the website.
	Sys/Ex. (System Exclusive)	Displays the System Exclusive data in the Song. Keep in mind that you cannot create new data or change the contents of the data here; however, you can delete, cut, copy, and paste the data.
	Meta (Meta event)	Displays the SMF meta events in the Song. Keep in mind that you cannot create new data or change the contents of the data here; however, you can delete, cut, copy, and paste the data.
	<b>● When the Editing Target is set to “Lyrics”:</b>	
	Name	Allows you to enter the Song name.
	Lyrics	Allows you to enter lyrics.
	Code	<ul style="list-style-type: none"> <li>• <b>CR:</b> Enters a line break in the lyrics text.</li> <li>• <b>LF:</b> Clears the currently displayed lyrics and displays the next set of lyrics.</li> </ul>
	<b>● When the Editing Target is set to “Chord”:</b>	
	Style	Style name
	Tempo	Tempo setting
	Chord	Chord root, Chord type, On Bass Chord
	Sect (Section)	Style Section (Intro, Main, Fill In, Break, Ending)
	OnOff	On/off status for each part (channel) of the Style
	CH.Vol (Channel Volume)	Volume for each part (channel) of the Style
	S.Vol (Style volume)	Overall volume of the Style
④	Song Position (Measure: Beat: Clock)	Indicates the current Song position. The events you input are recorded at the position indicated here. You can change the current position (Measure: Beat: Clock*) by using the Data dial. * Clock: Smallest unit for the Song position and note length. A quarter note consists of 1920 clocks.
⑤	▶/   (Play/Pause)	Plays back or pauses the current Song.
⑥	■ (Stop)	Stops the current Song to return to the top of the Song.
⑦	Cursor	For moving the cursor position.
⑧	Step Rec	Turning this on shows the Step Recording display, and turning it off shows the Step Edit display.
⑨	Event Filter	<p>Calls up the Event Filter window, letting you select only the events you wish to be shown in the event list.</p> <p> : Checkmark all items.</p> <p> : Remove checkmarks from all items.</p> <p> : Invert checked/unchecked for all items.</p>
⑩	Multi Select	After turning this on, use the Cursor buttons (⑦) on the display to select multiple events.
⑪	Cut/Copy/Paste	Use these when you want to copy or move the selected events.
⑫	Insert	Adds a new event.
⑬	Delete	Deletes the selected events.
⑭	Cancel	Cancels editing and restores the original value.



# Editing Song Position Markers

This section covers two additional Marker-related features and details. For basic information on using the Markers for jump playback and loop playback, refer to the Owner’s Manual.

## ■ Jump Markers

The Markers explained in the Owner’s Manual are also called “Jump Markers.” In the Event List of the System Exclusive data (page 83), they are indicated as “SPJ-01”–“SPJ-04.” In the Event List, they can be moved freely to other positions and can even be copied to create identical Marker numbers at other positions. When the same Marker number is contained at different locations in the Song, the latest occurring one is used as a “Loop End Marker” (below).

## ■ Loop End Marker

Loop End Markers can be used for putting additional Markers in Song data, providing even greater versatility. Creating a Loop End Marker is done within the Event List (and not on the Song Playback display), by simply copying one “SPJ” Jump Marker event to another position in the Song.

The examples below show how Loop End Markers can be used in Song playback on the Song Playback display.

### Example 1

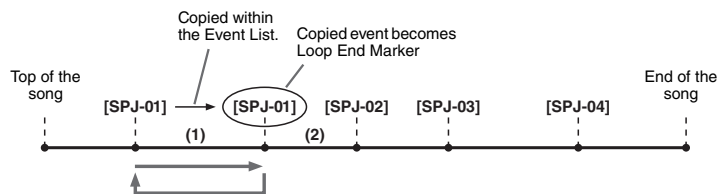

- (1) If the Song is playing back between the two SPJ-01 points, turning on [Loop] will result in a playback loop between those points.
- (2) If the Song is playing back between the second SPJ-01 and SPJ-02 and [Loop] is turned on, playback jumps back to the first SPJ-01 and loops between two SPJ-01 points.

### Example 2

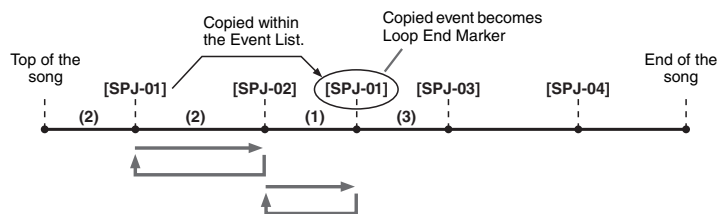

- (1) If the Song is playing back between SPJ-02 and the second SPJ-01, turning on [Loop] will result in a playback loop between those points.
- (2) If [Loop] is turned on while the Song is playing back between the top of the Song and SPJ-02, playback will loop between SPJ-01 and SPJ-02.
- (3) If the Song is playing back between the second SPJ-01 and SPJ-03 and [Loop] is turned on, playback jumps back to SPJ-02 and loops between SPJ-02 and the second SPJ-01 (Loop End Marker).

In the examples above, the actual data of the Loop End Marker is identical to the event it was copied from—only the location of the copied Marker provides it with this different function.

In Song playback, the markers formatted as “SPJ-xxxx” (xxxx: any character except 01–04 and any number of letters is OK) are handled as Loop End Markers. Since the Event List in the MIDI Multi Recording function does not let you freely name Markers, the instructions above are recommended for creating new Markers. However, with sequence software on a computer, you can create new Markers and assign appropriate names to them. By naming Markers in this way, you can easily distinguish between Loop End Markers and Jump Markers in the Event List.

#### NOTE

Loop playback problems may occur if successive Markers are too close to one another.

#### NOTE

When the effect settings of the jump destination (the position you’re jumping to) differ from those at the jump source, glitches or drop-outs in the sound may result. This is because of limitations in the effect processors of this instrument.

#### NOTE

When using the Guide function (page 65) with jump playback, keep in mind that the Guide indication may not be able to stay in time with the jumps.

# 6

# Registration Memory

## Contents

Disabling Recall of Specific Items (Registration Freeze) .....	86
Calling Up Registration Memory Numbers in Order (Registration Sequence) .....	87
Searching for a Registration Memory Bank File.....	89
• Adding Tags to a Registration Memory Bank for Easy Searching .....	90

## Disabling Recall of Specific Items (Registration Freeze)

Registration Memory lets you recall all the panel setups you made with a single button press. However, there may be times that you want certain items to remain the same, even when switching Registration Memory setups. For example, you may want to switch Voice settings while keeping the same Style. This is where the Freeze function comes in handy. It lets you maintain the settings of certain items and leave them unchanged, even when selecting other Registration Memory buttons.

The operation display can be called up via [MENU] → [Regist Freeze].

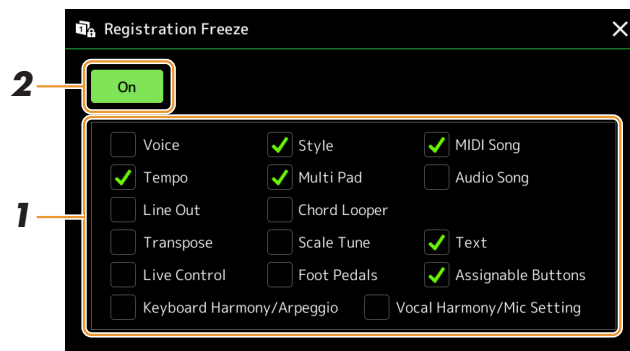

### 1 Enter the checkmark of the item or group to be “frozen.”

Refer to the Data List (Parameter Chart) on the website for details on which parameters belong to the Freeze group.

### 2 Set the Registration Freeze to “On.”

#### NOTE

The Registration Freeze function can also be turned on/off by pressing the [FREEZE] button.

# Calling Up Registration Memory Numbers in Order (Registration Sequence)

The Registration Sequence function conveniently lets you instantly change panel setups during a live performance—letting you call up the eight setups in any order you specify, by simply using the ASSIGNABLE buttons or the pedal as you play.

**1** If you intend to use a pedal or pedals to switch the Registration Memory number, connect the optional pedals to the appropriate ASSIGNABLE FOOT PEDAL jacks.

For instructions, refer to the Owner’s Manual.

**2** Press the REGIST BANK [-] and [+] buttons simultaneously to call up the Registration Bank Selection display.

**3** Select the desired Registration Memory Bank to create a sequence.

**4** Call up the Registration Sequence display via [MENU] → [Regist Sequence].

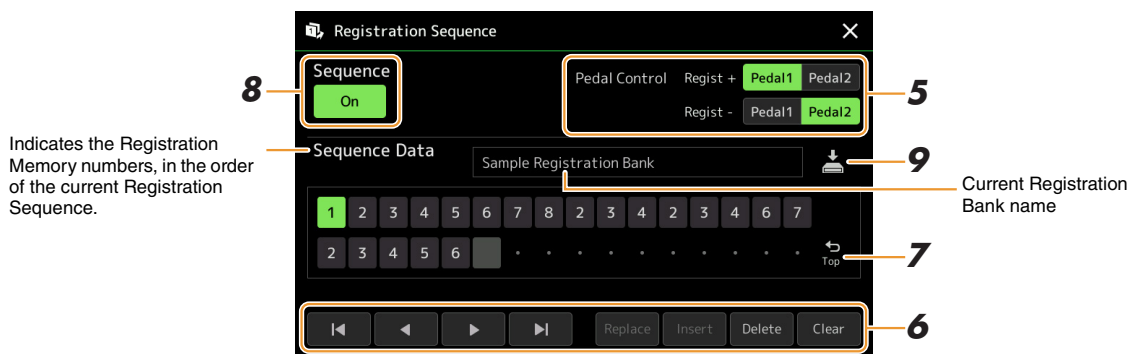

Indicates the Registration Memory numbers, in the order of the current Registration Sequence.

Current Registration Bank name

**5** If you intend to use a pedal to switch the Registration Memory number, specify here how the pedal will be used.

The pedal assigned to “Regist +” will be used for advancing through the sequence. The pedal assigned to “Regist -” will be used for reversing through the sequence.

If you intend to use the ASSIGNABLE button to switch the Registration Memory number, assign “Registration Sequence +” or “Registration Sequence -” in the display called up via [MENU] → [Assignable] (page 111).

**NOTE**

You can also assign other functions to the pedal—Voice Guide Controller (page 131), Punch In/Out of Song (page 71) and the function set in the Assignable display (page 111). If you assign multiple functions to the pedal, the priority is: Voice Guide Controller → Punch In/Out of Song → Registration Sequence → the function set in the Assignable display.

**6** Program a Sequence order in which the Registration Memory numbers are to be called up.

Basically, press the desired Registration Memory number button on the panel, then touch [Insert] to enter the selected number.

<p> ◀, ◀, ▶, ▶ </p>	<p>Moves the cursor.</p> <p><b>NOTE</b> If you want to move the cursor directly to an already entered number, touch the desired number.</p>
<p>Replace</p>	<p>Replaces the number of the cursor location with the currently selected Registration Memory number.</p>

Insert	Inserts the number of the currently selected Registration Memory number before the cursor position.
Delete	Deletes the number at the cursor position.
Clear	Deletes all numbers in the sequence.

## 7 Select the action that will result when the Registration Sequence reaches the end.

- **Stop:** Pressing the ASSIGNABLE button or the “advance” pedal has no effect. The sequence is “stopped.”
- **Top:** The sequence starts again at the beginning.
- **Next:** The sequence automatically moves to the beginning of the next Bank in the same folder of the Registration Bank Selection display.

## 8 Set the Registration Sequence to “On.”

The Registration Sequence programmed here is shown in the Registration Memory Bank area of the Home display. Press the ASSIGNABLE button or the pedal to check whether or not the Registration Memory number is called up in the order as programmed.

## 9 Touch (Save) to call up the File Selection display, then save the sequence program as a Registration Memory Bank file.

### **NOTICE**

Settings in the Registration Sequence display will be lost if you select another Registration Bank without carrying out the Save operation.

## Searching for a Registration Memory Bank File

You can quickly find desired Registration Memory Bank files from a large number of files by using the Search function.

- 1** Call up the operation display by touching  (Search) on the Registration Bank Selection display.
- 2** Touch the search box to call up the Character Entry window.

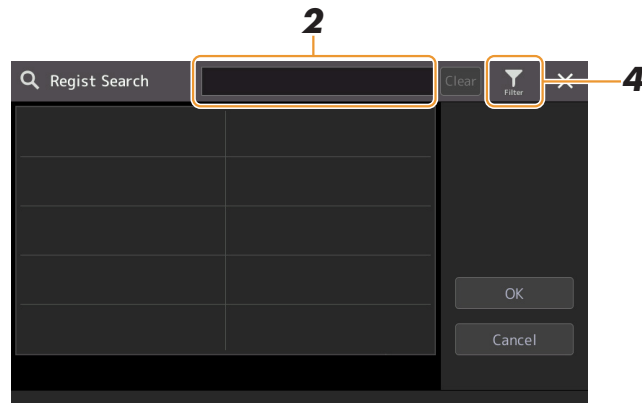

- 3** Enter the file name or the folder name (or just a part of it) to start searching.

If you want to enter multiple words, insert a space between each word.

After the search is complete, the resulting list appears. If you want to clear the result, touch [Clear].

- 4** If you want to narrow the search, touch  (Filter) and enter the search options in the box.

- **Tag:** Enter tags ([page 90](#)) to the box, or select tags from the list by touching [Existing Tag List]. If you want to enter multiple tags to the box, insert a space between each tag.
- **Song:** Enter the Song name.
- **Style:** Enter the Style name.
- **Style Tempo:** Enter the tempo range.

To clear each search query, touch [Clear]. To clear all, touch [All Clear].

Touching  (Filter) again returns to the search result.

- 5** Select the desired Registration Memory Bank file from the search result.

Touching [OK] closes the result display and calls up the selected Bank from the result. Touching [Cancel] closes the result display and returns to the previously selected Bank.

## Adding Tags to a Registration Memory Bank for Easy Searching

The tags of Registration Memory Banks help you to quickly find desired files when searching.

- 1** Select the desired Registration Memory Bank file to which you want to add tags.
- 2** On the Registration Bank Selection display, touch  (Menu) then [Regist Bank Tag Edit] to call up the operation display.
- 3** Touch [New Tag] to enter the desired text on the Character Entry window.

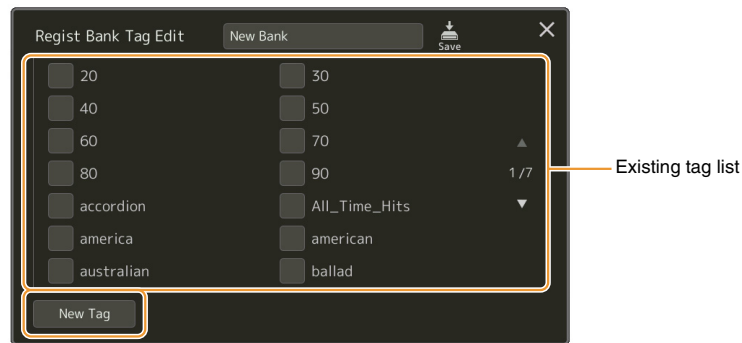

If you have already added any tags to another Registration Memory Bank file, existing tags appear in the list, and can be selected by entering checkmarks. It may take some time for the list to be shown.

- 4** Touch  (Save) to register the tag information to the Registration Memory Bank file.

## Contents

Importing Music Finder Records to the Playlist .....	91
--	----

## Importing Music Finder Records to the Playlist

By importing Music Finder Records used on previous Yamaha keyboards (such as the PSR-S975/S775), you can use the Records on the Playlist of the PSR-SX900/SX700, just like using the Music Finder function on those other instruments.

For details on using Music Finder, refer to the Owner's Manual of the Yamaha keyboard which contains your desired Music Finder Records.

- 1** Connect the USB flash drive which contains the Music Finder file (\*\*\*.mfd) to the [USB TO DEVICE] terminal of the instrument.
- 2** On the Playlist display, touch the Playlist file name to call up the Playlist File Selection display.

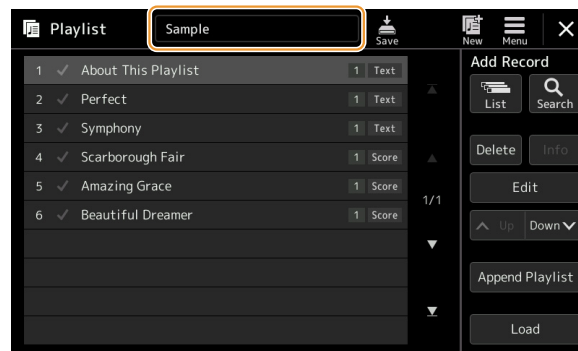

- 3** Select the desired Music Finder file to call up a confirmation message.
- 4** Touch [Yes] to start importing.

The imported Music Finder Records will be converted to Registration Memory Bank files and saved to a folder (with the same name as the imported file) in the User drive of this instrument.

At the same time, a Playlist of the converted Registration Memory Bank files (with the same name as the imported file) will be created in the USB flash drive. The Music Finder settings are registered to the Registration Memory number [1] for each Bank.

### NOTICE

If a folder with the same name as the Music Finder file already exists, the Registration Memory Bank file with the same name in that folder will be overwritten by the importing data. To avoid overwriting important data, change the folder name or the Music Finder file name.

- 5** Turn the [OTS LINK] button on to enable to use of the imported Records in the same way as the original Music Finder function.

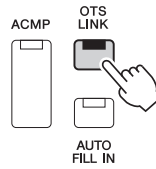

- 6** Touch the Record name on the Playlist display and load the settings contained in the Music Finder data.

#### **Searching for Records**

Since Music Finder data is saved to Registration Memory, you can search for Records on the Registration Bank Selection display. The keyword and genre of the Music Finder are saved as tag information.



## Contents

Making the Microphone or Guitar Settings (Mic Setting) .....	93
• Saving/Calling up the Microphone/Guitar Settings .....	95
Editing the Vocal Harmony Type (Vocal Harmony) (PSR-SX900) .....	96
Editing the Synth Vocoder Types (Vocal Harmony) (PSR-SX900).....	100

## Making the Microphone or Guitar Settings (Mic Setting)

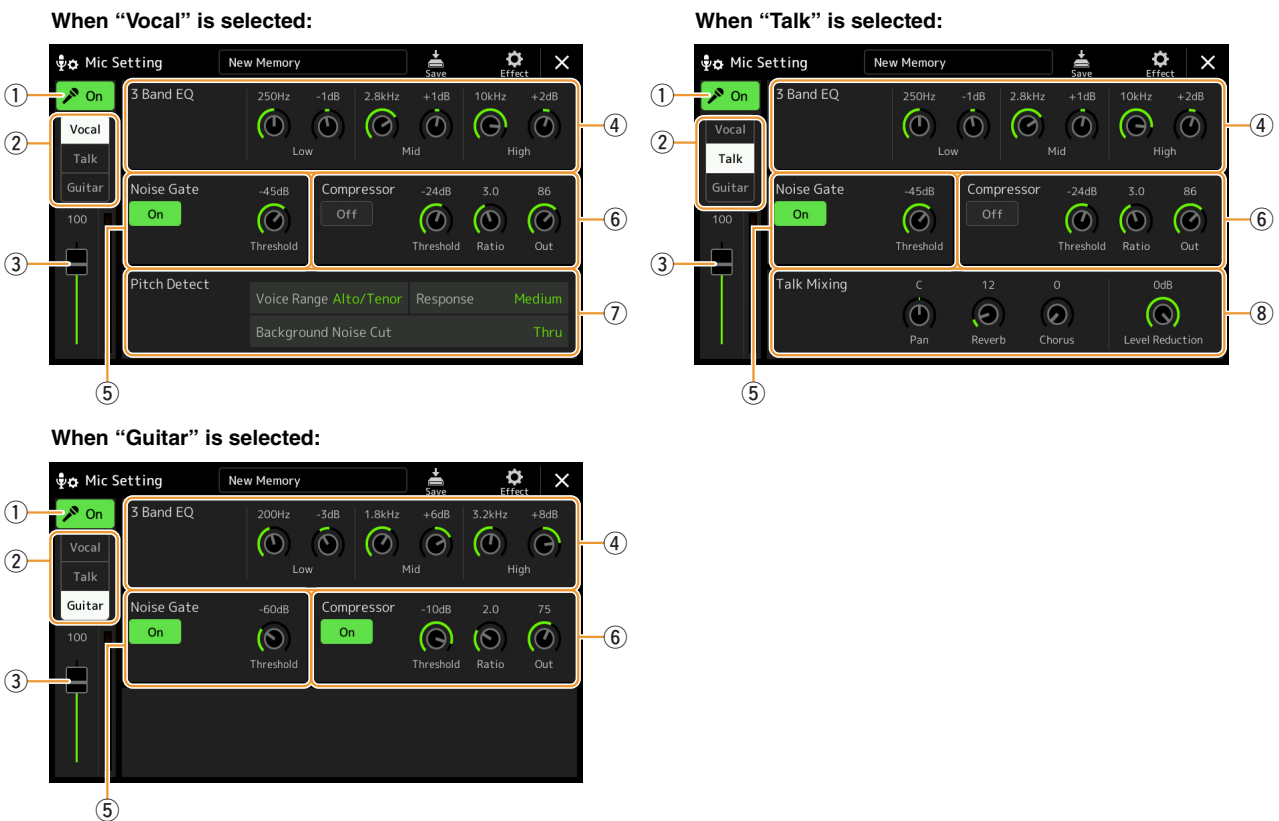

This section lets you set parameters for various Effects that are applied to the microphone or guitar sound. When using a microphone with the instrument, you should make both “Vocal” and “Talk” settings—Vocal, for your singing performance, and Talk, for making announcements between songs, for example. When using a guitar, select “Guitar” and make appropriate settings.

The operation display can be called up via [MENU] → [Mic Setting].



Microphone

①	Microphone On/Off	Turns the microphone/guitar sound on or off. When set to On, the microphone/guitar sound will be input to the instrument.  <b>NOTE</b> (PSR-SX900) The setting here is equivalent to that in the Vocal Harmony display (page 96).
②	Vocal/Talk/Guitar Switch	When you sing into the microphone for your performance, set this to “Vocal.” When you talk normally or need to make announcements between songs of your performance, set this to “Talk.” This lets you instantly change the microphone settings depending on the situation. When you use a guitar with the instrument, set this to “Guitar.”

③	Volume Adjustment	<p>Adjusts the input volume of the microphone/guitar sound. The input level is shown at the right.</p> <p> <b>NOTE</b></p> <p>(PSR-SX900) The setting here when “Vocal” is selected is equivalent to that in the Vocal Harmony display (page 96).</p>
④	3 Band EQ	<p>EQ (Equalizer) is a processor that divides the frequency spectrum into multiple bands which can be boosted or cut as required to tailor the overall frequency response. The instrument features a three-band (Low, Mid and High) digital equalizer function for the microphone sound. For each of three bands, you can adjust the center frequency (Hz) and level (dB) via the corresponding knobs on the display.</p>
⑤	Noise Gate	<p>This effect mutes the input signal when the input from the microphone falls below a specified level. This effectively cuts off extraneous noise, allowing the desired signal (vocal, etc.) to pass.</p>
	On/Off	Turns Noise Gate on or off.
	Threshold	Adjusts the input level above which the gate begins to open.
⑥	Compressor	<p>This effect holds down the output when the input signal from the microphone exceeds a specified level. This is especially useful for smoothing out vocals that have widely varying dynamics. It effectively “compresses” the signal, making loud parts softer, or vice versa.</p>
	On/Off	Turns Compressor on or off.
	Threshold	Adjusts the input level above which compression begins to be applied.
	Ratio	Adjusts the compression ratio. Higher ratios result in a more compressed sound, with a reduced dynamic range.
	Out	Adjusts the final output level.
⑦	Pitch Detect (only when “Vocal” is selected) (PSR-SX900)	<p>For setting how the pitch of the microphone sound during performance is detected.</p>
	Voice Range	<p>Set this to obtain the most natural vocal harmony, depending on your voice.</p> <ul style="list-style-type: none"> <li>• <b>Bass:</b> Designed to enhance lower voices. This setting is also appropriate for growling and shouting.</li> <li>• <b>Alto/Tenor:</b> Designed to enhance mid-range voices.</li> <li>• <b>Soprano:</b> Designed to enhance higher voices. This setting is also appropriate for singing close to the microphone.</li> <li>• <b>All Range:</b> Designed to enhance vocalists having a wide range, from Bass to Soprano.</li> </ul>
	Response	<p>Adjusts the response speed of the Vocal Harmony effect, or how quickly harmonies are generated in response to your voice.</p> <p> <b>NOTE</b></p> <p>When one or both of “Lead Pitch Detect Speed” and “Harm Pitch Detect Speed” parameters of Vocal Harmony (page 99) are set to “as Mic Setting,” this parameter is effective. In other settings, the setting of the Vocal Harmony’s Pitch Detect Response is effective.</p>
	Back-ground Noise Cut	<p>This allows you to filter out noises that would interfere with the pitch detection. A setting of “Thru” turns the noise filter off.</p>
⑧	Talk Mixing (only when “Talk” is selected)	<p>For making settings for speech (e.g., talking or making announcements between songs during a performance).</p>
	Pan	Determines the stereo pan position of the microphone sound.
	Reverb	Determines the depth of the reverb effects applied to the microphone sound.
	Chorus	Determines the depth of the chorus effects applied to the microphone sound.
	Level Reduction	Determines the amount of reduction to be applied to the overall sound (excepting the microphone input)—allowing you to effectively adjust the balance between your voice and the overall instrument sound.

**NOTICE**

The settings here are lost if you turn off the power without carrying out the Save operation.

 **NOTE**

To adjust Pan and Reverb/Chorus settings for the microphone/guitar sound when “Vocal” or “Guitar” is selected, use the Mic part settings on the Mixer display (page 107).

## Saving/Calling up the Microphone/Guitar Settings

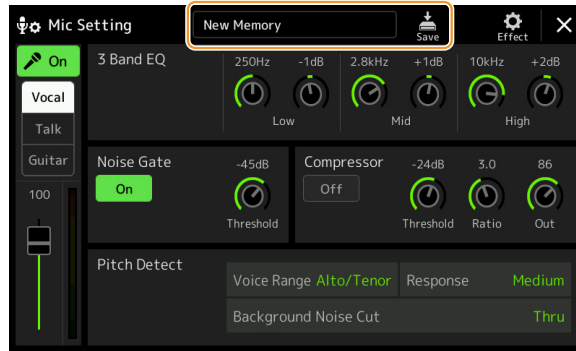

All the microphone/guitar settings can be saved as a single file by touching  (Save) on the Mic Setting display. Up to 60 files can be saved to the User memory of this instrument. For ease in future recall, you should assign a sufficiently descriptive name or one that matches your performance.

To call up the microphone/guitar settings, touch the setting name at left of  (Save) then select the desired file.

### NOTE

If you want to save the microphone/guitar settings to a USB flash drive, save as a User Effect file. To do this, on the display called up via [MENU] → [Utility] → [Factory Reset/Backup] → page 2/2, touch [Save] of "User Effect" to carry out the Save operation ([page 133](#)).

# Editing the Vocal Harmony Type (Vocal Harmony) (PSR-SX900)

By editing the parameters of the preset Vocal Harmony type, you can create your original Vocal Harmony type. The operation display can be called up via [MENU] → [Vocal Harmony].

- 1** Touch the Vocal Harmony name to call up the Vocal Harmony Selection display.
- 2** Touch [Vocal Harmony], and then select the desired Vocal Harmony type.
- 3** Depending on the selected Vocal Harmony type, edit the relevant settings as desired.

 **NOTE**

Check that the microphone is properly connected (see the Owner's Manual) and the settings are adjusted correctly (see the Reference Manual, page 93) before setting the Vocal Harmony parameters here.

When the Mode (2) is set to "Chordal":

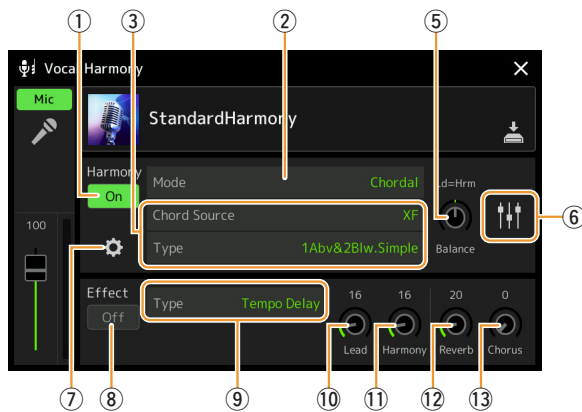

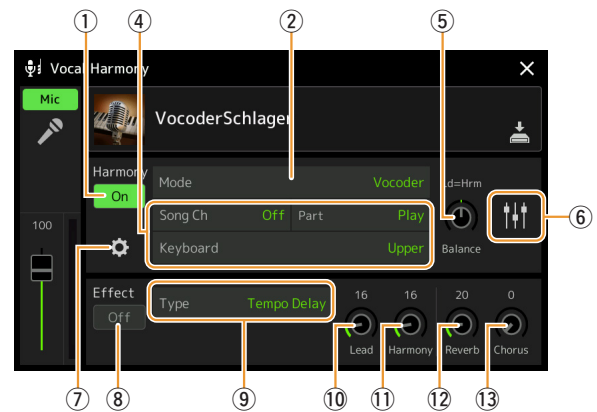

When the Mode (2) is set to "Vocoder" or "Vocoder-Mono":





## Harmony

For editing the Vocal Harmony parameters.

①	Harmony On/Off	Turns Vocal Harmony on or off. This is equivalent to the [VOCAL HARMONY] button on the panel.
②	Mode	Although one of the three following Modes is automatically selected when a Vocal Harmony type is selected, you can change the Mode.
	Chordal	The harmony notes are determined by the following three chord types: chords played in the chord section of the keyboard (with the [ACMP] button turned on), chords played in the left hand section of the keyboard (with the Left part turned on), and chords contained in Song data for controlling the harmony. (Not available if the Song does not contain any chord data.)
	Vocoder	The microphone sound is output via the notes you play on the keyboard or via the Song playback notes.
	Vocoder-Mono	Basically the same as the Vocoder. In this mode, only single-note melodies or lines can be played back (with last-note priority).

<b>③ (When the Mode is set to “Chordal”)</b>	
Chord Source	<p>Determines which data or event of a Song will be used for chord detection.</p> <ul style="list-style-type: none"> <li>• <b>Off:</b> Disables chord detection from the Song data.</li> <li>• <b>XF:</b> Chord data defined via XF will be used.</li> <li>• <b>1–16:</b> Detects a chord from notes of the MIDI channel specified here.</li> </ul> <p> <b>NOTE</b></p> <p>The Vocal Harmony may not work properly regardless of the setting here depending on the Song data, since the selected Song may contain no chord data or insufficient note data for chord detection.</p>
Type	<p>Determines how the harmony notes are applied to the microphone sound by selecting one of the Chordal Types. Almost all Types apply the harmony notes based on the chord specified via the left hand section of the keyboard, chord section of the keyboard, or the Song data, with the exception of the following two Types.</p> <ul style="list-style-type: none"> <li>• <b>ScaleDiatonic:</b> This generates harmony notes based on the Key Root and Key Type specified in the Harmony Assign display (⑦), meaning that the harmony notes do not depend on the chord but match the diatonic scale of the current song’s key signature.</li> <li>• <b>Parallel:</b> This adds a note to the lead note (microphone sound) with the interval specified at ⑥, regardless of the chord.</li> </ul> <p> <b>NOTE</b></p> <p>“Abv” in the Chordal Type List means that the harmony notes are generated above the lead note (microphone sound) while “Blw” means that the harmony notes are generated below the lead note.</p> <p>For more information about the Chordal Types, refer to the Data List (Vocal Harmony Parameter List) on the website.</p>
<b>④ (When the Mode is set to “Vocoder” or “Vocoder-Mono”)</b>	
Song Ch	When set to one of 1–16, note data (played from a Song on this instrument or the connected computer) of the corresponding channel is used to control the harmony. When set to “Off,” Song data control over harmony is turned off.
Part	When set to “Mute,” the channel selected above (to control Harmony) is muted (turned off) during Song playback, allowing you to disable control via specific channels as desired.
Keyboard	<ul style="list-style-type: none"> <li>• <b>Off:</b> Keyboard control over harmony is turned off.</li> <li>• <b>Upper:</b> Notes played to the right of the Split Point (Left) control the harmony.</li> <li>• <b>Lower:</b> Notes played to the left of the Split Point (Left) control the harmony.</li> </ul> <p> <b>NOTE</b></p> <p>When the settings of both keyboard performance and Song data are applied, those settings are merged to control the harmony.</p>
<b>⑤</b>	<p><b>Balance</b></p> <p>Lets you set the balance between the lead vocal (the microphone sound) and Vocal Harmony sound. Raising this value increases the volume of the Vocal Harmony and decreases that of the lead vocal. When this is set to L&lt;H63 (L: Lead Vocal, H: Vocal Harmony), only the Vocal Harmony is output; when it is set to L63&gt;H, only the lead vocal is output.</p>

⑥	Balance adjustment for each Lead note and Harmony note	<p>The following parameters can be adjusted for each Lead note (microphone sound) and Harmony note.</p> <ul style="list-style-type: none"> <li>• <b>Transpose:</b> For shifting the pitch of each Harmony note and Lead note. The range for all notes is the same; however, the lead note can only be adjusted in octaves.</li> </ul> <p>When the Chordal Type is set to “ScaleDiatonic,” this parameter changes to Degree, letting you shift the pitch in degree from -3 octaves (-22 scale degrees) – Unison (1 scale degree) – +3 octaves (+22 scale degrees).</p> <ul style="list-style-type: none"> <li>• <b>Detune:</b> Determines the fine pitch setting for each Harmony note from -50 cents to +50 cents.</li> <li>• <b>Formant:</b> Determines the formant setting for each Harmony note. The higher the value, the more “feminine” the harmony voice becomes. The lower the value, the more “masculine” the voice.</li> <li>• <b>Pan:</b> Determines the pan position setting for each Harmony note. Setting each Harmony note to a different pan position, with the Lead vocal at center, for example, results in a naturally wide stereo sound.</li> <li>• <b>Volume:</b> Determines the volume setting for each Harmony note. Use this to adjust the relative level balance among the Lead vocal and the Harmony notes.</li> </ul> <p> <b>NOTE</b></p> <p>When Pitch Correct Mode (⑦) is set to OFF the Lead part is not available for the Transpose, Detune and Formant parameters.</p> <p> <b>NOTE</b></p> <p>The Transpose values of the Harmonies are available only when the Mode (②) is set to “Chordal.”</p>
⑦	Harmony Assign	<p>For setting how the Harmony notes are assigned or voiced to the Lead note (microphone sound). For details, refer to the Data List (Vocal Harmony Parameter List) on the website.</p> <p>● <b>When the Harmony mode is set to “Chordal”</b></p> <ul style="list-style-type: none"> <li>• <b>Session Table:</b> Determines how the harmonies will be voiced, or what type of chord will be used in creating the harmonies, according to different musical styles.</li> </ul> <p> <b>NOTE</b></p> <p>This parameter is available only when the Chordal Type is set to something other than “ScaleDiatonic” or “Parallel.”</p> <ul style="list-style-type: none"> <li>• <b>Key Root, Key Type:</b> When the Chordal Type (③) is set to “ScaleDiatonic,” this parameter is available. Harmony notes based on the settings here do not depend on the chord but match the diatonic scale of the current song’s key signature.</li> </ul> <p>● <b>When the Harmony mode is set to “Vocoder” or “Vocoder-Mono”</b></p> <ul style="list-style-type: none"> <li>• <b>Transpose Mode:</b> Determines the amount by which the harmony parts are transposed. A setting of “0” results in no transposition, while the “Auto” setting results in automatic transposition.</li> </ul>

⑦	Detail Setting	<ul style="list-style-type: none"> <li>• <b>Pitch Correct Mode:</b> Corrects the pitch of the Lead note (microphone sound). “Off” does not correct while “Hard” corrects the pitch most accurately.</li> <li>• <b>Humanize:</b> This setting allows you to make the Vocal Harmony sounds more natural and less “electronic,” by introducing slight time discrepancies between the Lead and Harmony notes. <ul style="list-style-type: none"> <li><b>Off:</b> No Humanize effect.</li> <li><b>1:</b> The Humanize effect is applied to the Harmony to create a more natural feel, with an authentic-sounding widening effect, giving the impression of more people singing.</li> <li><b>2:</b> The Humanize effect is applied to the Harmony to produce a more distinct groove. Even faster passages retain their rhythmic essence.</li> <li><b>3:</b> The Humanize effect is applied to the Harmony to reflect the way in which the lead vocalist and back chorus interact, with the lead vocal out front, and the timing slightly relaxed.</li> </ul> </li> <li>• <b>Lead Pitch Detect Speed, Harm Pitch Detect Speed:</b> Determines how fast the pitch of the Lead note and the harmony notes are detected in response to the signal via the microphone. “1” responds most slowly, “4” is standard, “15” responds most quickly, and “as Mic Setting” gives priority to the speed specified at the Pitch Detect “Response” of the Mic Setting display (page 94).</li> <li>• <b>Harmony Effect:</b> Determines the Effect type applied to the Harmony notes added to the Lead note.</li> <li>• <b>Harmony Stability:</b> Determines the stability degree to which the Harmony is applied to the Lead note. When set to “Stable,” this has a relatively stable sound with little harmony motion. When set to “Dynamic,” this tends to add harmony with motion according to the input sound.</li> <li>• <b>Lead Vibrato Depth:</b> This specifies the vibrato depth of the lead sound.</li> <li>• <b>Harm Vibrato Depth:</b> This specifies the vibrato depth of the harmony sound.</li> <li>• <b>Vibrato Speed:</b> This specifies the vibrato speed of both the lead and harmony sounds.</li> <li>• <b>Vibrato Delay:</b> This specifies the vibrato delay of both the lead and harmony sounds.</li> </ul> <p>For more information about the parameters of Detail Settings, refer to the Data List (Vocal Harmony Parameter List) on the website.</p>
---	----------------	--

## Effect

For editing parameters related to the Effects applied to the Vocal Harmony notes.

⑧	Effect On/Off	Turns on or off the Effects applied to the Vocal Harmony notes.
⑨	Type	Selects the Effect type applied to the Vocal Harmony notes. You can edit also the detailed parameters of the selected type. For details, refer to the Data List (“Vocal Effect Type List” for the Vocal Harmony Effect types, and “Vocal Harmony Parameter List” for the Vocal Harmony Effect parameters) on the website.
⑩	Lead	Adjusts the Effect depth applied to the Lead note.
⑪	Harmony	Adjusts the Effect depth applied to the Harmony notes.
⑫	Reverb	Adjusts the Reverb depth applied to the microphone sound. This setting is equivalent to that in the Mixer display (page 107).
⑬	Chorus	Adjusts the Chorus depth applied to the microphone sound. This setting is equivalent to that in the Mixer display (page 107).

## 4 Touch (Save), then save the edits as an original Vocal Harmony type.

A total of 60 types (Vocal Harmony and Synth Vocoder types) can be saved. For ease in future recall, you should assign a descriptive name that matches the settings.

### NOTICE

The settings here are lost if you turn off the power without carrying out the Save operation.

### NOTE

If you want to save the Vocal Harmony settings to a USB flash drive, save as a User Effect file. To do this, on the display called up via [MENU] → [Utility] → [Factory Reset/Backup] → page 2/2, touch [Save] of “User Effect” to carry out the Save operation (page 133).

# Editing the Synth Vocoder Types (Vocal Harmony) (PSR-SX900)

By editing the parameters of the preset Synth Vocoder type, you can create your original Synth Vocoder type. The operation display can be called up via [MENU] → [Vocal Harmony].

- 1** Touch the Vocal Harmony name to call up the Vocal Harmony Selection display.
- 2** Touch [Synth Vocoder], and then select the desired Synth Vocoder type.
- 3** Depending on the selected Synth Vocoder type, edit the relevant settings as desired.

 **NOTE**

Check that the microphone is properly connected (see the Owner's Manual) and the settings are adjusted correctly (see the Reference Manual, page 93) before setting the Synth Vocoder parameters here.

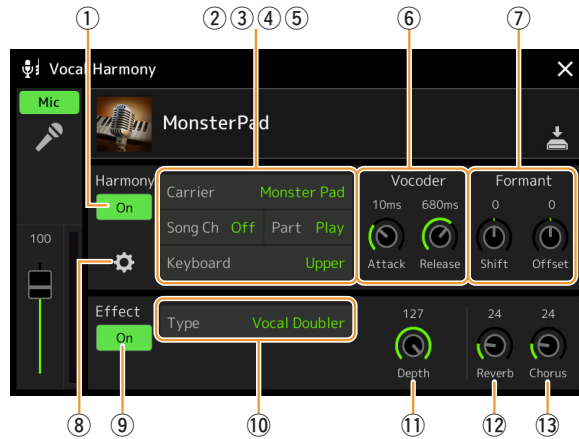

## Harmony

Lets you edit the Synth Vocoder parameters.

①	Harmony On/Off	Turns Synth Vocoder on or off. This is equivalent to the [VOCAL HARMONY] button on the panel.
②	Carrier	Selects the musical instrument sound used as the source (Carrier) for the Synth Vocoder. (The Carrier serves as the basic sound over which the vocal characteristics are applied.)
③	Song Ch	When set to one of 1–16, note data (played from a Song on this instrument or the connected computer) of the corresponding channel is used to control the harmony. When set to “Off,” Song data control over harmony is turned off.
④	Part	When set to “Mute,” the channel selected above (to control Harmony) is muted (turned off) during Song playback, allowing you to disable control via specific channels as desired.
⑤	Keyboard	<ul style="list-style-type: none"> <li>• <b>Off:</b> Keyboard control over harmony is turned off.</li> <li>• <b>Upper:</b> Notes played to the right of the Split Point (Left) control the harmony.</li> <li>• <b>Lower:</b> Notes played to the left of the Split Point (Left) control the harmony.</li> </ul> <p> <b>NOTE</b></p> <p>When the settings of both keyboard performance and Song data are applied, those settings are merged to control the harmony.</p>
⑥	Vocoder	<ul style="list-style-type: none"> <li>• <b>Attack:</b> Determines the attack time of the Synth Vocoder sound. The higher the value, the slower the attack.</li> <li>• <b>Release:</b> Determines the release time of the Synth Vocoder sound. The higher the value, the slower the decay.</li> </ul>
⑦	Formant	<ul style="list-style-type: none"> <li>• <b>Shift:</b> Determines how the cutoff frequencies of all BPFs (for the Inst Input) are shifted, in BPF units. This parameter can be used to coarsely change the character of the Vocoder sound.</li> <li>• <b>Offset:</b> Adjusts the cutoff frequencies of all BPFs (for the Inst Input) finely. This parameter can be used to finely change the character of the Vocoder sound.</li> </ul>



⑧	Detail Setting	Carrier	<ul style="list-style-type: none"> <li>• <b>Volume:</b> Determines the level of the Carrier for the Synth Vocoder sound.</li> <li>• <b>Noise:</b> Determines the noise level which is input to the Synth Vocoder. This can be used to emphasize sibilant and plosive sounds, and make the speech-like characteristics more pronounced.</li> <li>• <b>Octave:</b> Determines the octave setting of the Carrier for the Synth Vocoder sound.</li> </ul>
		HPF (High Pass Filter)	<ul style="list-style-type: none"> <li>• <b>Freq (Frequency):</b> Determines the HPF cutoff frequency for the microphone input sound. Setting this to a low value results in a minimally processed input sound—in other words, close to the original. Setting this to higher values emphasizes the higher frequency consonant and sibilant sounds (making words easier to understand).</li> <li>• <b>Level:</b> Determines the level of the microphone sound output from the HPF.</li> </ul>
		BPF1–10 (Band Pass Filter)	<p>Determines each output gain of the BPF 1–10 for the Inst Input (keyboard performance sound). BPF 1 corresponds to the lowest Formant while BPF 10 corresponds to the highest Formant.</p> <p> <b>NOTE</b> Feedback (howling) may result depending on the setup settings. Be careful especially when you increase values</p>

## Effect

For editing parameters related to the Effects applied to the Synth Vocoder notes.

⑨	Effect On/Off	Turns on or off the Effects applied to the Synth Vocoder notes.
⑩	Type	Selects the Effect type applied to the Synth Vocoder notes. You can edit also the detailed parameters of the selected type. For details, refer to the Data List (“Vocal Effect Type List” for the Synth Vocoder Effect types, and “Vocal Harmony Parameter List” for the Synth Vocoder Effect parameters) on the website.
⑪	Depth	Adjusts the Effect depth applied to the overall Synth Vocoder sound.
⑫	Reverb	Adjusts the Reverb depth applied to the microphone sound. This setting is equivalent to that in the Mixer display (page 107).
⑬	Chorus	Adjusts the Chorus depth applied to the microphone sound. This setting is equivalent to that in the Mixer display (page 107).

## 4 Touch (Save), then save the edits as an original Synth Vocoder type.

A total of 60 types (Synth Vocoder and Vocal Harmony types) can be saved. For ease in future recall, you should assign a descriptive name that matches the settings.

### NOTICE

The settings here are lost if you turn off the power without carrying out the Save operation.

### NOTE

If you want to save the Synth Vocoder settings to a USB flash drive, save as a User Effect file. To do this, on the display called up via [MENU] → [Utility] → [Factory Reset/Backup] → page 2/2, touch [Save] of “User Effect” to carry out the Save operation (page 133).

## Contents

Editing Filter Parameters (Filter).....	102
Editing EQ Parameters (EQ) .....	103
Editing Effect Parameters (Effect) .....	105
• Editing and Saving the Effect settings .....	106
Editing Effect Parameters (Chorus/Reverb).....	107
• Editing and Saving the Chorus/Reverb settings.....	107
Editing Pan/Volume Settings (Pan/Volume).....	107
Editing Master Compressor Settings (Compressor) .....	108
Block Diagram .....	110

The Owner's Manual covers the basic procedure of using the Mixer function. This Reference Manual provides more detailed information on each display (or function) of the Mixer display called up via [MENU] → [Mixer]. The “Panel”–“Song” Part Selection tabs at the top of the Mixer display let you adjust the sound for each corresponding part, while “Master” lets you make overall sound adjustments for the entire instrument.

### NOTE

Knobs and sliders appear on the setting displays only when the relevant parameters are available.

For a visual indication of the signal flow and configuration of the Mixer, refer to the Block Diagram on [page 110](#).

## Editing Filter Parameters (Filter)

This function modifies the tonal characteristics (brightness, etc.) of the sound by cutting the output of a specific frequency portion of the sound. This is not available when you select “Master” from among the tabs at the top of the Mixer display.

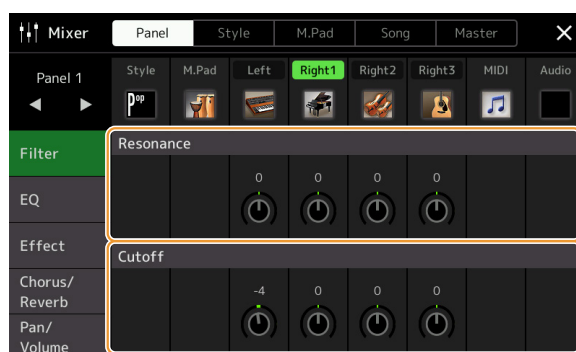

Resonance	Allows you to adjust the Resonance effect ( <a href="#">page 48</a> ) for each part. This can be used in combination with the “Cutoff” parameter to add further character to the sound.
Cutoff	Determines the brightness of the sound for each part by adjusting the cutoff frequency ( <a href="#">page 48</a> ).

## Editing EQ Parameters (EQ)

Equalizer (also called “EQ”) is a sound processor that divides the frequency spectrum into multiple bands that can be boosted or cut as required to tailor the overall frequency response. The “Panel”–“Song” Part Selection tabs at the top of the Mixer display let you adjust the EQ for each corresponding part, while “Master” lets you make overall EQ adjustments for the entire instrument.

### Part EQ (when one of the “Panel”–“Song” tabs is selected)



High	Boosts or cuts the high EQ band for each part.
Low	Boosts or cuts the low EQ band for each part.

### Master EQ (When the “Master” tab is Selected)

This instrument possesses a high-quality eight-band digital EQ. With this function, a final effect—tone control—can be applied to the output of your instrument. You can select one of the five preset EQ types in the “Master” display. You can even create your own custom EQ settings by adjusting the frequency bands, and save the settings to one of 30 User Master EQ types.

#### NOTE

Master EQ cannot be applied to an Audio Song, the audio input via the AUX IN jack, or the metronome sound.

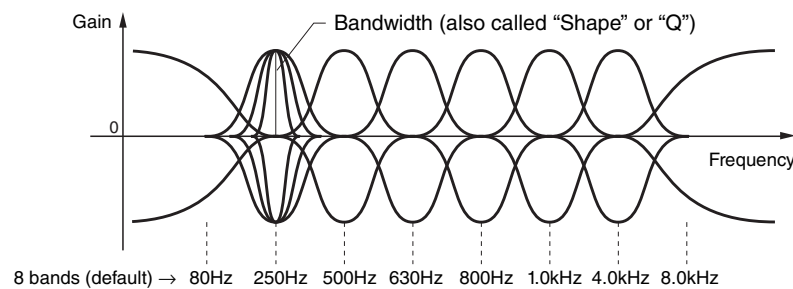



## 1 Select the desired EQ type to be edited.

- **Flat:** Flat EQ settings. The gain of each frequency is set to 0dB.
- **Powerful:** Powerful EQ settings in which all frequency sounds are emphasized. This can be used to boost the music for parties, etc.
- **Mellow:** Soft and mellow EQ settings in which high-frequency bands are reduced slightly.
- **Bright:** EQ setting for boosting the level of the high frequencies, making the sound brighter.
- **With Subwoofer:** Custom EQ settings in which low-frequency bands are reduced. This is an optimum setting for using this instrument along with a subwoofer, such as the KS-SW100 (sold separately).
- **User1–30:** Your own custom EQ settings saved in step 4.

## 2 Adjust the Q (bandwidth) and the Center Frequency of each band.

The available Frequency range is different for each band. The higher the value of Q, the narrower the bandwidth.

## 3 Adjust the Gain level to boost or cut each of the eight bands as desired.

## 4 Touch (Save) to save the settings as a User Master EQ type.

Up to 30 EQ types can be created and saved.

### NOTICE

The settings will be lost if you turn the power to the instrument off without carrying out the Save operation.

### NOTE

If you want to save the Master EQ settings to the USB flash drive, save as a User Effect file. To do this, from the display called up via [MENU] → [Utility] → [Factory Reset/Backup] → page 2/2, touch [Save] of "User Effect" to carry out the Save operation ([page 133](#)).

## Editing Effect Parameters (Effect)

This instrument features the following Effect Blocks.

- **System Effect (Chorus, Reverb):** These Effects are applied to the entire sound of this instrument. For each part, you can adjust the depth of the System Effect. This can be set on the “Chorus/Reverb” display (page 107).
- **Insertion Effect 1–8 (PSR-SX900), 1–5 (PSR-SX700):** These Effects are applied only to a specific part. For each of these Effects, select an Effect type specifically for the desired part (for example, Distortion, which would be applied only to the Guitar part).
- **Variation Effect:** This Block can be used both as System Effects and Insertion Effects, and you can switch between them.

This section covers the settings related to the Insertion Effects and Variation Effect on the Effect display. This display is not available when the “Master” tab is selected at the top of the Mixer display.



Insertion Effect	<p>Allows you to assign the desired Insertion Effect Type for each part by touching the area above each knob. You can adjust the degree to which each Effect is applied by using the knobs.</p> <p>If you want to assign each of the Insertion Effects to a specific Part and select an Effect Type, touch [Assign Part Setting] at the upper right of this area and make necessary settings in the window.</p> <p>The assignable Parts for each Insertion Effect are as follows:</p> <p><b>PSR-SX900</b></p> <ul style="list-style-type: none"> <li>• <b>Insertion Effect 1–5:</b> Keyboard Parts, Song channels 1–16</li> <li>• <b>Insertion Effect 6:</b> Keyboard Parts, Song channels 1–16, Microphone</li> <li>• <b>Insertion Effect 7–8:</b> Style Parts (except the Audio Part of the Audio Style)</li> </ul> <p><b>PSR-SX700</b></p> <ul style="list-style-type: none"> <li>• <b>Insertion Effect 1–4:</b> Keyboard Parts, Song channels 1–16</li> <li>• <b>Insertion Effect 5:</b> Keyboard Parts, Song channels 1–16, Microphone</li> </ul>
Variation Effect	<p>Touch [Insertion] or [System] to switch the Effect Connection between the Insertion Effect and System Effect, then touch the right end of this line to select the desired Effect type.</p> <p>When “System” is selected, this Effect is applied to all parts of the Song and Style as the System Effect. When “Insertion” is selected, this Effect is applied only to the specified Song/Style part.</p> <p>To adjust the degree to which the Effect is applied, use the knob of each part.</p> <p><b>NOTE</b></p> <p>This is not available when the “Panel” or the “M.Pad” tab is selected at the top of the Mixer display.</p>

## Editing and Saving the Effect settings

You can edit the settings of the System Effects (Chorus, Reverb), Insertion Effects and Variation Effect. The edits can be saved as a User Effect type.

- 1** From the Mixer display, touch the Effect type name to call up the Effect setting display.

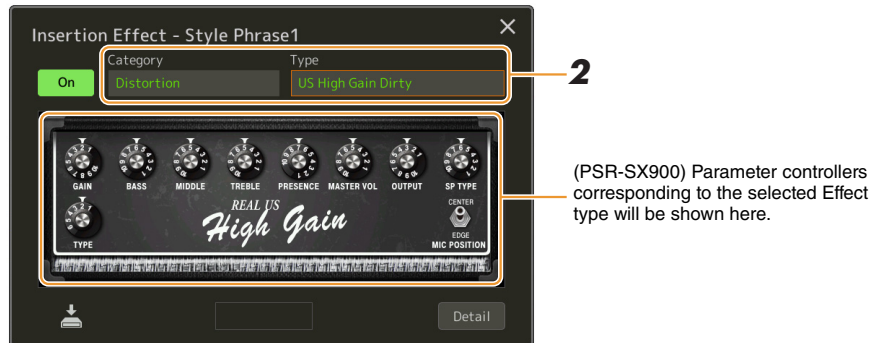

- 2** Select the Effect Category and Type.

On the PSR-SX900, you can adjust the parameter values using the controllers shown on the display.

- 3** Touch [Detail] to call up the Effect Parameter display to make additional settings.

The available parameters differ depending on the Effect type.

- 4** Touch  (Save) to save the settings as a User Effect type.

Up to 30 Effect types can be stored for each of the Reverb, Chorus, Variation, and Insertion Effect Blocks.

### NOTE

Parameters that are grayed out cannot be edited.

### **NOTICE**

**The settings will be lost if you turn the power to the instrument off without executing the Save operation.**

### NOTE

If you want to save the Effect settings to a USB flash drive, save as a User Effect file. To do this, from the display called up via [MENU] → [Utility] → [Factory Reset/Backup] → page 2/2, touch [Save] of "User Effect" to execute the Save operation ([page 133](#)).

## Editing Effect Parameters (Chorus/Reverb)

As described in the previous section, Chorus and Reverb are System Effects which are applied to the entire sound of the instrument. They are not available when the “Master” tab is selected at the top of the Mixer display.



Chorus	Touch the Chorus type name at the top right of this row to select the desired Chorus type. After selecting, return to the Mixer display then use each knob to adjust the Chorus depth for each part.
Reverb	Touch the Reverb type name at the top right of this row to select the desired Reverb type. After selecting, return to the Mixer display then use each knob to adjust the Reverb depth for each part.

### NOTE

For details about the Chorus and Reverb types, refer to the Data List (Effect Type List) on the website.

## Editing and Saving the Chorus/Reverb settings

Same as the operation on the “Effect” display (page 105).

## Editing Pan/Volume Settings (Pan/Volume)

You can adjust the Pan (stereo position of the sound) and Volume for each Part. This display is not available when the “Master” tab is selected at the top of the Mixer display.



①	Pan	Determines the stereo position of each part (channel).
②	Volume	Determines the level of each part or channel, giving you fine control over the balance of all the parts.

# Editing Master Compressor Settings (Compressor)

Compressor is an effect commonly used to limit and compress the dynamics (softness/loudness) of an audio signal. For signals that vary widely in dynamics, such as vocals and guitar parts, it “squeezes” the dynamic range, effectively making soft sounds louder and loud sounds softer. When used with gain to boost the overall level, this creates a more powerful, more consistently high-level sound.

This instrument features a Master Compressor which is applied to the entire sound of this instrument. Although preset Master Compressor settings are provided, you can also create and save your original Master Compressor presets by adjusting the related parameters. This display is available only when the “Master” tab is selected at the top of the Mixer display.

**NOTE**

Master Compressor cannot be applied to an Audio Song, the audio input via the AUX IN jack, or the metronome sound.

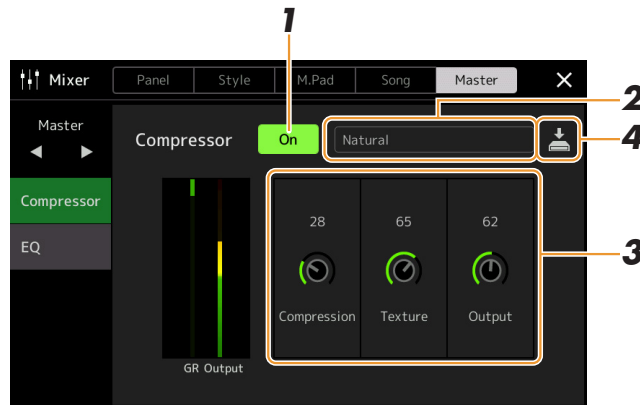

## 1 Set the Compressor to “On.”

## 2 Select the Master Compressor type to be edited.

- **Natural:** Natural Compressor settings in which the effect is moderately pronounced.
- **Rich:** Rich Compressor settings in which the instrument’s characteristics are optimally enhanced. This is good for enhancing acoustic instruments, jazz music, etc.
- **Punchy:** Highly exaggerated Compressor settings. This is good for enhancing rock music.
- **Electronic:** Compressor settings in which the electronic dance music’s characteristics are optimally enhanced.
- **Loud:** Powerful Compressor settings. This is good for enhancing energetic music such as rock or gospel music.
- **User1–30:** Your own custom Compressor settings saved in step 4.

## 3 Edit the parameters related to the Master Compressor.

Compression	Parameters such as Threshold, Ratio and Soft Knee (which are available on commonly used compressors) are all changed together at the same time, letting you moderately compress the sound.
Texture	Adds natural characteristics to the effect. The higher the value, the lighter it becomes.  <b>NOTE</b> It may be easier to hear the changes when used in combination with “Compression” and “Output.”
Output	Determines the output level.

The indication “GR” shows the Gain Reduction (compressed level) while “Output” shows the output level according to the instrument sound in real time.



#### 4 Touch (Save) to save the settings as a User Master Compressor type.

Up to 30 Master Compressor types can be created and saved.

#### **NOTICE**

The settings will be lost if you turn the power to the instrument off without carrying out the Save operation.

#### **NOTE**

If you want to save the Master Compressor settings to a USB flash drive, save them as a User Effect file. To do this, from the display called up via [MENU] → [Utility] → [Factory Reset/Backup] → page 2/2, touch [Save] of “User Effect” to carry out the Save operation ([page 133](#)).

# Block Diagram

## PSR-SX900

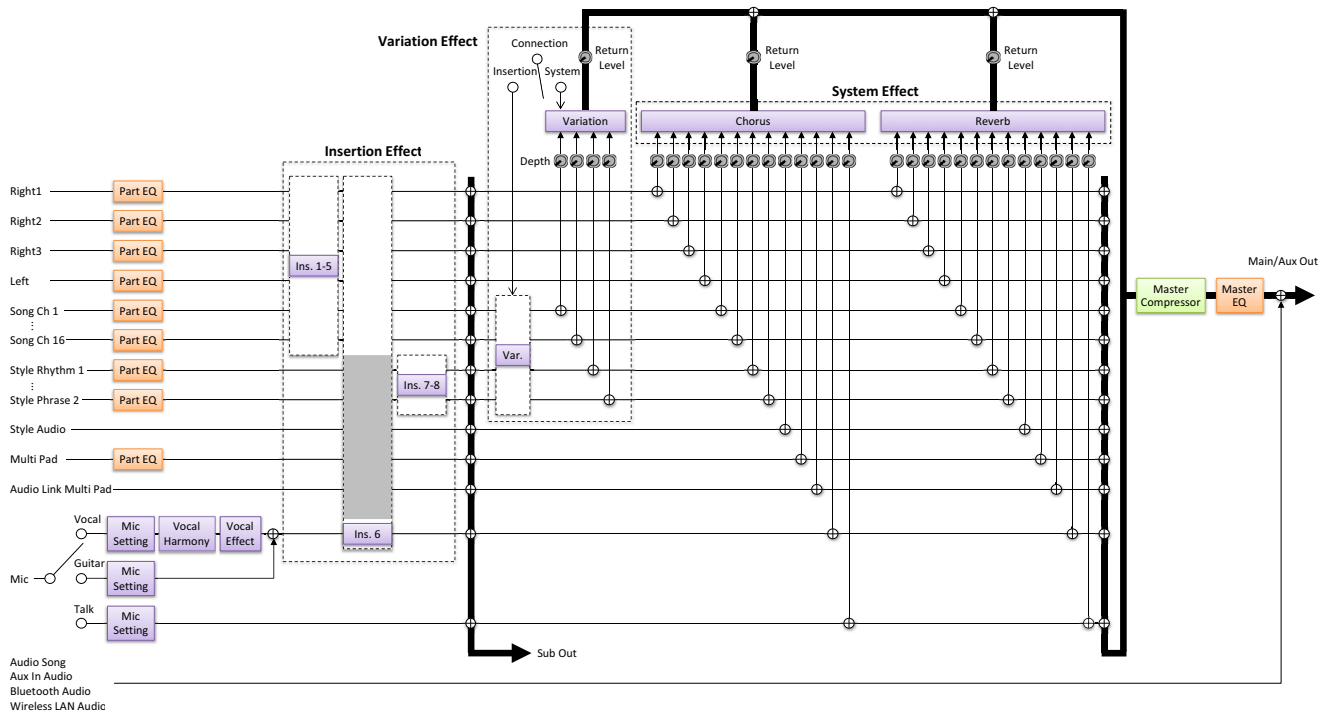

## PSR-SX700

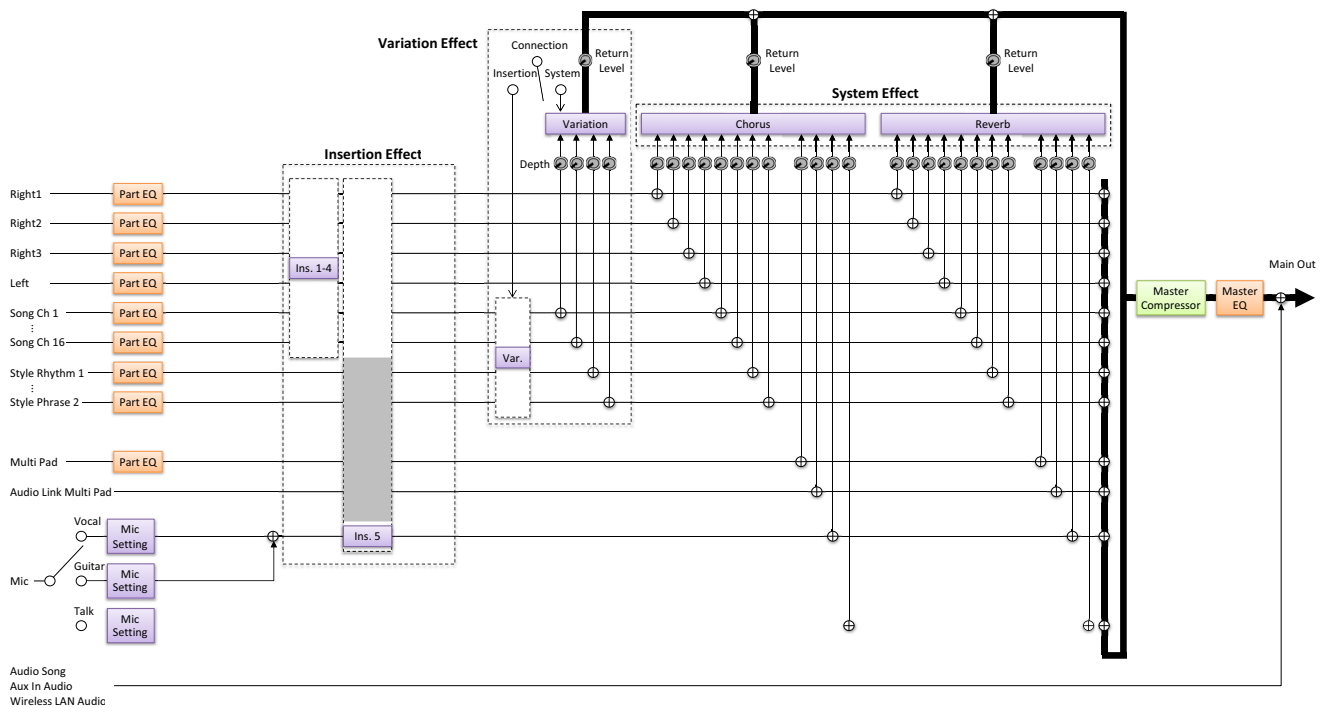

## Contents

Assigning Specific Functions to the Pedals and Panel Buttons (Assignable) .....	111
• Assignable Functions (Assignable display) .....	112
Editing the Assign Types of the Live Control Knobs (Live Control) .....	117
• Assignable Functions (Live Control display) .....	118

## Assigning Specific Functions to the Pedals and Panel Buttons (Assignable)

You can assign various functions to foot pedals connected to the FOOT PEDAL jacks, as well as the ASSIGNABLE buttons and the [ROTARY SP/ASSIGNABLE] button.

The operation display can be called up via [MENU] → [Assignable].

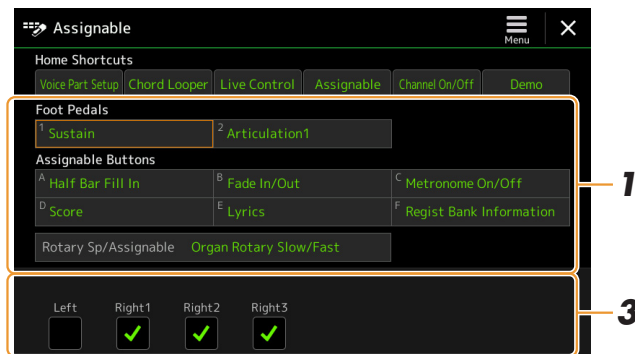

### 1 Touch to select the desired pedal or button.

Touching it again calls up the function list.

### 2 Select the function for the pedal or button.

For information about each function, refer to pages 112–116.

### 3 Make necessary settings of the selected function shown at the bottom of the display.

You can make detailed settings of the selected function, such as which parts are affected by the function, etc. If you want to change the function name that appears on the pop-up window, touch [Rename] and enter the desired name. Up to 50 characters can be used.

### 4 If necessary, set the polarity of the pedal by touching (Menu).

Depending on the pedal you've connected to the instrument, it may work in the opposite way (i.e., pressing it has no effect, but releasing it does). If such a case occurs, use this setting to reverse the polarity.

#### NOTE

As described in the Owner's Manual, shortcuts can also be assigned to the ASSIGNABLE buttons.

#### NOTE

You can also assign other functions to the pedal—Voice Guide Controller (page 131), Punch In/Out of Song (page 71) and Registration Sequence (page 87). If you assign multiple functions to the pedal, the priority is: Voice Guide Controller → Punch In/Out of Song → Registration Sequence → Functions assigned here

#### Hiding the pop-up window when the ASSIGNABLE buttons are pressed

When you press one of the ASSIGNABLE buttons, the pop-up window displaying the assigned function status is shown. You can also set the pop-up window to be hidden. To do so, touch  (Menu) on the Assignable display, and then set the “Popup Window” to Off.



## Assignable Functions (Assignable display)



In the list below, “P” indicates the pedals, “A” indicates the ASSIGNABLE buttons, and “R” indicates the [ROTARY SP/ASSIGNABLE] button. The functions marked by “O” are available for the corresponding pedals or buttons.

For functions indicated with “\*”, use only the foot controller; proper operation cannot be done with a Footswitch.



### NOTE

You can make detailed settings of each function on the bottom of the Assignable display, such as which parts will be affected by the function, etc (items are depending on each function).

Functions			Assignability		
Category	Function	Description	P	A	R
Voice	Articulation 1/2	When you use a Super Articulation Voice that has an effect corresponding to this function, you can enable the effect by pressing the pedal/footswitch/button assigned to this function.	○	○	○
	Volume*	Controls the volume by using a foot controller.	○	-	-
	Sustain	Controls the sustain. When you press and hold the pedal, all notes played on the keyboard have a longer sustain. Releasing the pedal immediately stops (damps) any sustained notes.	○	-	-
	Panel Sustain On/Off	Same as the VOICE EFFECT [SUSTAIN] button.	○	○	○
	Sostenuto	Controls the Sostenuto effect. If you play a note or chord on the keyboard and press the pedal while holding the note(s), the notes will sustain as long as the pedal is held. However, all subsequent notes will not sustain. This makes it possible to sustain a chord, for example, while other notes are played staccato.   <b>NOTE</b> This function will not affect any of the Organ Flutes and only some of the Super Articulation Voices.	○	-	-
	Soft	Controls the Soft effect. Pressing this pedal reduces the volume and changes the timbre of the notes you play. This is effective only for certain appropriate Voices.	○	-	-
	Glide	When the pedal is pressed, the pitch changes, and then returns to normal pitch when the pedal is released. You can make the following settings at the bottom of this display. • <b>Up/Down:</b> Determines whether the pitch change goes up (is raised) or down (is lowered). • <b>Range:</b> Determines the range of the pitch change, in semitones. • <b>On Speed:</b> Determines the speed of the pitch change when the pedal is pressed. • <b>Off Speed:</b> Determines the speed of the pitch change when the pedal is released.	○	-	-
	Mono/Poly	Switches whether the Voice is played monophonically or polyphonically.	○	○	○
	Portamento	A portamento effect (a smooth slide between notes) can be produced while the pedal is pressed. Portamento is produced when notes are played legato style (i.e., a note is played while the preceding note is still held). The portamento time can also be adjusted from the Voice Edit display (page 47).   <b>NOTE</b> This function affects only certain Voices, especially synth lead and some bass Voices. It will not affect any of the Organ Flutes, and only some of the Super Articulation Voices, even if the function has been assigned to the Foot Pedals.	○	-	-
Portamento Time*	Controls the Portamento Time parameter of each keyboard part by using a foot controller. For details on Portamento Time, see page 47.	○	-	-	

Functions			Assignability		
Category	Function	Description	P	A	R
Voice	Pitch Bend*	Allows you to bend the pitch of notes up or down by using the pedal. You can make the following settings at the bottom of this display. <ul style="list-style-type: none"> <li>• <b>Up/Down:</b> Determines whether the pitch change goes up (is raised) or down (is lowered).</li> <li>• <b>Range:</b> Determines the range of the pitch change, in semitones.</li> </ul>	○	-	-
	Modulation (+), (-)*	Applies vibrato and other effects to notes played on the keyboard.	○	-	-
	Modulation (+), (-) Alt	This is a slight variation on Modulation above, in which the effects (waveform) can be alternately turned on/off by each press of the pedal/foot-switch.	○	○	○
	Modulation Hold On/Off	Same as the [MODULATION HOLD] button.	○	○	-
	Initial Touch On/Off	Turns the Initial Touch setting of each keyboard part on the Keyboard/Joy-stick display on/off.	○	○	-
	Left Hold On/Off	Same as the [LEFT HOLD] button.	○	○	-
	Pedal Control (Wah)	Applies a wah effect to notes played on the keyboard. You can turn this function on or off for each keyboard part at the bottom of this display. <p> <b>NOTE</b></p> <p>The effect can be applied only to specific Voices.</p>	○	-	-
	Organ Rotary Slow/Fast	Switches the Rotary Speaker speed (page 50) between “Slow” and “Fast.”	○	○	○
	Kbd Harmony/Arpeggio On/Off	Same as the [HARMONY/ARPEGGIO] button.	○	○	-
Registration	Arpeggio Hold	While the pedal is pressed (hold on), Arpeggio playback continues even after you release the keyboard, and then Arpeggio stops when the pedal is released (hold off). When this function is assigned to the button, each press of the button alternately toggles between hold on and hold off. Make sure that any one of the Arpeggio type is selected and the [HARMONY/ARPEGGIO] button is turned on.	○	○	-
	Registration Memory	Same as the REGISTRATION MEMORY [MEMORY] button.	○	○	-
	Registration Memory 1–8	Same as the REGISTRATION MEMORY [1]–[8] buttons.	○	○	-
	Registration Sequence +/-	Advances/reverses through the Registration Sequence. <p> <b>NOTE</b></p> <p>If you want to use a pedal, set the “Pedal Control” on the Registration Sequence display (page 87).</p>	-	○	-
	Registration Bank +/-	Same as the REGIST BANK [+]/[-] buttons.	○	○	-
	Registration Freeze On/Off	Same as [On]/[Off] on the Registration Freeze display (page 86).	○	○	-
Live Control	Registration Sequence On/Off	Same as [On]/[Off] on the Registration Sequence display (page 87).	○	○	-
	Live Control Assign	Same as the LIVE CONTROL [ASSIGN] button.	○	○	-
Chord Looper	Live Control Reset Value	Same as [Reset Value] on the Live Control display (page 117). Resets the values of all the assignable functions of Live Control.	○	○	-
	Chord Looper On/Off (PSR-SX900)	Same as the CHORD LOOPER [ON/OFF] button.	○	○	-
	Chord Looper Rec/Stop (PSR-SX900)	Same as the CHORD LOOPER [REC/STOP] button.	○	○	-

Functions			Assignability		
Category	Function	Description	P	A	R
Style	Style Start/Stop	Same as the STYLE CONTROL [START/STOP] button.	○	○	-
	Synchro Start On/Off	Same as the [SYNC START] button.	○	○	-
	Synchro Stop On/Off	Same as the [SYNC STOP] button.	○	○	-
	Intro1–3	Same as the INTRO [I]–[III] buttons.	○	○	-
	Main A–D	Same as the MAIN VARIATION [A]–[D] buttons.	○	○	-
	Fill Down	Plays a fill-in, which is automatically followed by the Main section of the button on the immediate left.	○	○	-
	Fill Self	Plays a fill-in.	○	○	-
	Fill Break	Plays a break.	○	○	-
	Fill Up	Plays a fill-in, which is automatically followed by the Main section of the button on the immediate right.	○	○	-
	Ending1–3	Same as the ENDING/rit. [I]–[III] buttons.	○	○	-
	Acmp On/Off	Same as the [ACMP] button.	○	○	-
	OTS Link On/Off	Same as the [OTS LINK] button.	○	○	-
	Auto Fill In On/Off	Same as the [AUTO FILL IN] button.	○	○	-
	Half Bar Fill In	While the pedal is pressed, the “Half bar fill-in” function is turned on and changing sections of a Style at the first beat of the current section starts the next section from the middle with automatic fill-in. When this function is assigned to the button, each press of the button alternately toggles between the function being turned on and off. When you select an Audio Style, the function does not work.	○	○	○
	Fade In/Out	Turns the Fade In /Fade Out function of Style/MIDI Song playback on/off. The following parameters can be set at the bottom of this display. • <b>Fade In Time:</b> Determines the time it takes for the Style/Song volume to fade in, or go from minimum to maximum (range of 0–20.0 seconds). • <b>Fade Out Time:</b> Determines the time it takes for the Style/Song volume to fade out, or go from maximum to minimum (range of 0–20.0 seconds). • <b>Fade Out Hold Time:</b> Determines the time the volume is held at 0 following the fade out (range of 0–5.0 seconds).	○	○	○
Fingered/Fingered On Bass	The pedal alternately switches between the “Fingered” and “Fingered On Bass” modes (page 8).	○	○	-	
Bass Hold	While the pedal is pressed, the Style bass note will be held even if the chord is changed during Style playback. When this function is assigned to the button, the function is turned on once the button is pressed, turned off one more pressed. If the fingering is set to “AI Full Keyboard,” the function does not work.	○	○	-	
One Touch Setting1–4	Same as the ONE TOUCH SETTING [1]–[4] buttons.	○	○	-	
One Touch Setting +/-	Calls up the next/previous One Touch Setting.	○	○	-	
Multi Pad	Multi Pad1–4	Same as the MULTI PAD CONTROL [1]–[4] buttons.	○	○	-
	Multi Pad Synchro Start	Same as the MULTI PAD CONTROL [SYNC START, SELECT] button.	○	○	-
	Multi Pad Stop	Same as the MULTI PAD CONTROL [STOP] button.	○	○	-

Functions			Assignability		
Category	Function	Description	P	A	R
Song	Song MIDI Play/Pause	Same as the SONG MIDI [▶/⏸] (PLAY/PAUSE) button.	○	○	-
	Song MIDI Previous	Same as the SONG MIDI [◀◀] (PREV) button.	○	○	-
	Song MIDI Next	Same as the SONG MIDI [▶▶] (NEXT) button.	○	○	-
	Song MIDI Synchro Start On/Off	Same as MIDI  (Sync Start) on the Song Playback display.	○	○	-
	Song MIDI Single Repeat On/Off	Same as MIDI  (Repeat) on the Song Playback display.	○	○	-
	Song MIDI Position Memorize On/Off	Same as Song Position [M] on the Song Playback display of the Song Player mode.	○	○	-
	Song MIDI Position Marker1-4	Same as Song Position [1]-[4] on the Song Playback display of the Song Player mode.	○	○	-
	Song MIDI Position Loop On/Off	Same as Song Position [Loop] on the Song Playback display of the Song Player mode.	○	○	-
	Song Audio Play/Pause	Same as the SONG AUDIO [▶/⏸] (PLAY/PAUSE) button.	○	○	-
	Song Audio Previous	Same as the SONG AUDIO [◀◀] (PREV) button.	○	○	-
	Song Audio Next	Same as the SONG AUDIO [▶▶] (NEXT) button.	○	○	-
	Song Audio Single Repeat On/Off	Same as Audio  (Repeat) on the Song Playback display of the Song Player mode.	○	○	-
	Song Audio Vocal Cancel On/Off	Same as Audio  (Vocal Cancel) on the Song Playback display of the Song Player mode.	○	○	-
	Song Audio Time Stretch*	Controls Audio  100% (Time Stretch) setting on the Song Playback display by using a foot controller.	○	-	-
	Song Audio Pitch Shift*	Controls Audio  0 (Pitch Shift) setting on the Song Playback display by using a foot controller.	○	-	-
	Song Audio A-B Repeat	Same as  (A-B Repeat) on the Song Playback display of the Song Player mode.	○	○	-
	Song List Shuffle On/Off	Same as  (Shuffle) on the Song Playback display of the Song List mode (page 58).	○	○	-
	Score Page +/-	While the Song is stopped, you can turn to the next/previous score page (one page at a time).	○	○	-
Lyrics Page +/-	While the Song is stopped, you can turn to the next/previous lyrics page (one page at a time).	○	○	-	
Text Viewer Page +/-	You can turn to the next/previous text page (one page at a time).	○	○	-	
Mic	Talk On/Off	Turns the Talk function On/Off. When turned on, the settings on the Mic Setting display automatically are changed to “Talk.”	○	○	-
	VH Harmony On/Off (PSR-SX900)	Turns the Vocal Harmony On/Off. Same as Harmony [On]/[Off] on the Vocal Harmony display.	○	○	-
	VH Effect On/Off (PSR-SX900)	Turns the Vocal Effect On/Off. Same as Effect [On]/[Off] on the Vocal Harmony display.	○	○	-

Functions			Assignability		
Category	Function	Description	P	A	R
Overall	Part On/Off	Turns the desired parts on/off at once.	-	○	-
	Insertion Effect On/Off	Turns the Insertion Effects (page 105) on or off.	○	○	○
	Metronome On/Off	Turns the metronome on or off.	○	○	-
	Tempo +/-	Same as the TEMPO [ + ]/[ - ] buttons.	○	○	-
	Reset/Tap Tempo	Same as the [RESET/TAP TEMPO] button.	○	○	-
	Master Tempo	Same as “Master Tempo” of Live Control (page 119). Changes the tempo of the currently selected Style or Song. The available tempo range differs depending on the selected Style/Song.	○	-	-
	Style Tempo Lock/Reset	Pressing the pedal or button changes the “Tempo” setting on the Style Setting display from “Reset” to “Lock.” Pressing again returns the setting to “Reset.” For details on the Style Change Behavior “Tempo,” see page 13.	○	○	○
	Style Tempo Hold/Reset	Pressing the pedal or button changes the “Tempo” setting on the Style Setting display from “Reset” to “Hold.” Pressing again returns the setting to “Reset.” For details on the Style Change Behavior “Tempo,” see page 13.	○	○	○
	Transpose +/-	Same as the TRANSPOSE [ + ]/[ - ] buttons.	○	○	-
	Upper Octave +/-	Same as the UPPER OCTAVE [ + ]/[ - ] buttons.	○	○	-
	Scale Tune Quick Setting	Allows to make the Sub Scale setting (page 43) directly. While pressing the pedal or button to which this function is assigned, press the desired keys and then release the pedal or button. This enables the Sub Scale with the keys you entered set to -50 cents. To release the Sub Scale setting, press the pedal or button, and then release it without pressing any keys.	○	○	○
	Scale Tune Bypass On/Off	Same as [Bypass] on the Scale Tune Main/Sub display. Disables all the Scale Tune settings (both Main and Sub) temporarily. This lets you hear the sound for comparison purposes.	○	○	○
	Percussion	The pedal plays a percussion instrument selected at the bottom of this display (or in the window called up by touching “Kit” “Category” or “Instrument”). In the Drum Kit Instrument Selection window, you can also use the keyboard to select an instrument.   <b>NOTE</b> When you select the percussion instrument by pressing a key on the keyboard, the velocity with which you press the key determines the percussion volume.	○	-	-
	Voice Guide On/Off	Turns the Voice Guide function on or off (page 131).	○	○	-
No Assign	No function is assigned.	-	○	○	



# Editing the Assign Types of the Live Control Knobs (Live Control)

The setups of functions for Live Control knobs (called “Assign Types”) can be changed as desired from a variety of options.

The operation display can be called up via [MENU] → [Live Control].

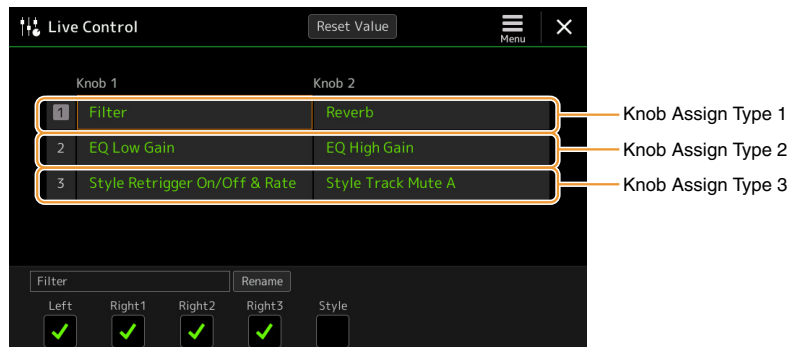

## 1 Touch to select the desired knob.

Touching it again calls up the function list.

## 2 Select the function for the knob.

For information about each function, refer to pages 118–119.

## 3 Make necessary settings of the selected function shown at the bottom of the display.

You can make detailed settings of the selected function, such as which parts are affected by the function, etc.

If you want to change the function name that appears on the Live Control pop-up window, touch [Rename] and enter the desired name. Up to 50 characters can be used.

### Hiding the pop-up window when the knob is operated

When you press the LIVE CONTROL [ASSIGN] button or rotate the knobs, the Live Control pop-up window displaying the status of the parameter is shown.

You can set the pop-up window to remain hidden when the knob is rotated but shown only when the [ASSIGN] button is pressed. To do so, touch  (Menu) on the Live Control display, and then set the “Popup Window” to Off.

### Reset the values of all the assignable functions of Live Control

Touching [Reset Value] on the top of the Live Control display allows you to reset all value settings for the functions that can be assigned to the knobs to the factory default values.

#### NOTE

If you want to reset the value of the function assigned to each knob individually, press the [ASSIGN] button or rotate the knob to call up the Live Control pop-up window, and then touch [Reset] on the desired function indication.

## Assignable Functions (Live Control display)

### NOTE

You can make detailed settings of each function on the bottom of the Live Control display, such as which parts will be affected by the function, etc (items are depending on each function).

Category	Function	Description
Mixer	Volume	Adjusts the volume of the selected parts or channels.
	Keyboard Volume	Adjusts the volume of all keyboard parts. This is convenient for adjusting the volume of all keyboard parts together for optimum balance with the others (MIDI Song, Style, Multi Pads, etc.).
	Balance	Adjusts the volume balance between parts A and B. You can select which parts belong to A or B in the pop-up window called up via [Balance Setting] at the bottom of this display.
	MIDI/Audio Song Balance	Adjusts the volume balance between MIDI Song playback and Audio Song playback.
	Pan	Determines the stereo position of the selected parts.
	Reverb	Adjusts the Reverb depth of the selected parts.
	Chorus	Adjusts the Chorus depth of the selected parts.
	Reverb & Chorus	Adjusts both Reverb and Chorus depth of the selected parts.
	Insertion Effect Depth	Adjusts the Insertion Effect depth of the selected parts.
	EQ High Gain	Boosts or attenuates the high EQ band for the selected parts.
	EQ Low Gain	Boosts or attenuates the low EQ band for the selected parts.
	Cutoff	Adjusts the cutoff frequency of the filter for the selected parts.
	Resonance	Adjusts the resonance of the filter for the selected parts.
	Cutoff & Resonance	Adjusts the cutoff frequency and resonance of the filter for the selected parts.
Filter	Adjusts the parameters such as the cutoff frequency and resonance of the filter for the selected parts. However, the parameters do not change uniformly, but are specially programmed to change individually for optimum sound, letting you filter the sound for the best musical results.	
Voice Edit	Attack	Adjusts the length of time until the selected parts reach their maximum level after the key is played. You can turn this function on or off for each keyboard part at the bottom of this display.   NOTE <ul style="list-style-type: none"> <li>Some Voices (such as Piano and E. Piano Voices) may not be affected by the setting here.</li> </ul>
	Release	Adjusts the length of time until the selected parts decay to silence after the key is released.
	Attack & Release	Adjusts both the Attack and Release time of the selected parts.
	Modulation (+), Modulation (-)	Applies vibrato and other effects to notes played on the keyboard.
Voice Setting	Tuning	Determines the pitch of the selected keyboard parts.
	Octave	Determines the range of the pitch change in octave for the selected keyboard parts.
	Pitch Bend Range	Determines the pitch bend range (page 38) for the selected keyboard parts.
	Portamento Time	Determines the portamento time (page 39) for the selected keyboard parts.

Category	Function	Description
Harmony/Arpeggio	Kbd Harmony/ Arpeggio Volume	Adjusts the volume of the Keyboard Harmony or Arpeggio function.
	Arpeggio Velocity	Adjusts the velocity of each note of Arpeggio. The value shown in the pop-up window is indicated as a percentage of the default value for each Arpeggio type.
	Arpeggio Gate Time	Adjusts the length of each note of Arpeggio. The value shown in the pop-up window is indicated as a percentage of the default value for each Arpeggio type.
	Arpeggio Unit Multiply	Adjusts the Arpeggio speed. The value shown in the pop-up window is indicated as a percentage of the default value for each Arpeggio type.
Style	Style Retrigger Rate	Adjusts the Style Retrigger length. This is shown as 1, 2, 4, 8, 16 or 32 on the pop-up window, indicating the note lengths. The first part of the current Style is repeated in the specified length.
	Style Retrigger On/ Off	Turns the Style Retrigger function on/off. When set to on, a specific length of the first part of the current Style is repeated when the chord is played.   <b>NOTE</b> <ul style="list-style-type: none"> <li>The Style Retrigger function is applied only to the Main section of the Style.</li> </ul>
	Style Retrigger On/ Off & Rate	Turns the Style Retrigger function on/off and adjusts its length. Rotating the knob to the left-most turns the function off; rotating it to the right turns the function on and decreases the length.
	Style Track Mute A	Turns playback of the Style channels on/off. Rotating the knob to the left-most position turns on only the Rhythm 2 channel, and the other channels are turned off. By rotating the knob clockwise from that position, channels are turned on in the order of Rhythm 1, Bass, Chord 1, Chord 2, Pad, Phrase 1, Phrase 2, and all channels are turned on when the knob reaches to the right-most position.
	Style Track Mute B	Turns playback of the Style channels on/off. Rotating the knob to the left-most position turns on only the Chord 1 channel, and the other channels are turned off. By rotating the knob clockwise from that position, channels are turned on in the order of Chord 2, Pad, Bass, Phrase 1, Phrase 2, Rhythm 1, Rhythm 2, and all channels are turned on when the knob reaches to the right-most position.
Mic	VH Harmony Balance (PSR- SX900)	Sets the balance between the lead vocal and Vocal Harmony sound. For details, refer to Harmony “Balance” on <a href="#">page 98</a> .
	VH Effect To Lead (PSR-SX900)	Adjusts the Vocal Harmony Effect depth applied to the Lead note. For details, refer to Effect “Lead” on <a href="#">page 99</a> .
Overall	Master Tempo	Changes the tempo of the currently selected Style or Song. The available tempo range differs depending on the selected Style/Song.
	No Assign	No function is assigned.

## Contents

Basic Procedure for MIDI Settings .....	120
System—MIDI System Settings .....	122
Transmit—MIDI Transmit Channel Settings .....	123
Receive—MIDI Receive Channel Settings .....	124
On Bass Note—Setting the Bass Note for Style Playback via MIDI.....	125
Chord Detect—Settings for Chords used in Style Playback via MIDI.....	125

## Basic Procedure for MIDI Settings

In this section, you can make MIDI-related settings for the instrument. This instrument gives you a set of ten pre-programmed templates that let you instantly and easily reconfigure the instrument to match your particular MIDI application or external device. Also, you can edit the pre-programmed templates and save up to ten of your original templates.

The operation display can be called up via [MENU] → [MIDI].

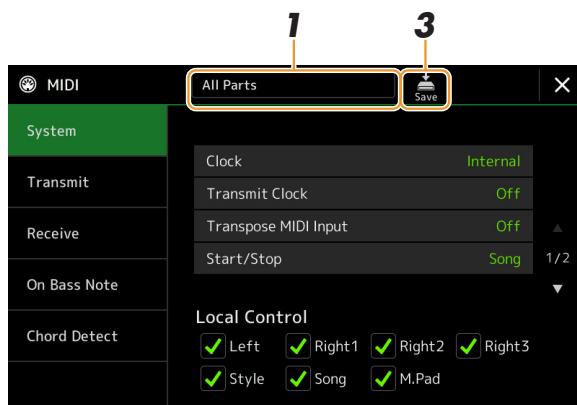

### 1 Touch the box (shown at top of the display), then select a pre-programmed MIDI template.

If you have already created an original MIDI template and saved it to User memory (in steps 2 and 3 below), you can also select that template from User memory.

For details on the pre-programmed MIDI templates, see [page 121](#).



## 2 If desired, edit the MIDI parameters based on the MIDI template selected in step 1 in the relevant setting display.

- **System:** For setting the MIDI System related parameters. ....page 122
- **Transmit:** For setting the MIDI Transmission related parameters. ....page 123
- **Receive:** For setting the MIDI Reception related parameters. ....page 124
- **On Bass Note:** For selecting the MIDI channels over which MIDI data coming from the external MIDI device will be used for detecting the bass note for Style playback.  
.....page 125
- **Chord Detect:** For selecting the MIDI channels over which MIDI data coming from the external MIDI device will be used for detecting the chord type for Style playback.  
.....page 125

## 3 When you've finished editing in each display, touch (Save) to save the MIDI settings as your original MIDI template.

### NOTE



Your original MIDI templates can be saved as a single file to a USB flash drive. On the display called up via [MENU] → [Utility] → [Factory Reset/Backup] → page 2/2, touch [Save] of "MIDI" to carry out the Save operation (page 133).

### ■ Pre-programmed MIDI Templates

All Parts	Transmits all parts including the keyboard parts (Right 1–3, and Left), with the exception of the Song parts.
KBD & STYLE	Basically the same as "All Parts" with the exception of how keyboard parts are managed. The right-hand parts are handled as "Upper" instead of Main and Layer, and the left-hand part is handled as "Lower."
Master KBD (Master Keyboard)	In this setting, the instrument functions as a "master" keyboard, playing and controlling one or more connected tone generators or other devices (such as a computer/sequencer).
Song	All transmit channels are set to correspond to Song channels 1–16. This is used to play Song data with an external tone generator and to record Song data to an external sequencer.
Clock Ext. (Clock External)	Playback or recording (Song, Style, etc.) synchronizes with an external MIDI clock instead of the instrument's internal clock. This template should be used when you want tempo (synchronization) to be controlled from the connected MIDI device.
MIDI Accord1 (MIDI Accordion 1)	MIDI accordions allow you to transmit MIDI data and play connected tone generators from the keyboard and bass/chord buttons of the accordion. This template lets you control the keyboard performance and Style playback from a MIDI Accordion.
MIDI Accord2 (MIDI Accordion 2)	Basically the same as "MIDI Accord1" above, with the exception that the chord/bass notes you play with your left hand on a MIDI Accordion are recognized also as MIDI note events.
MIDI Pedal1	MIDI pedal units allow you play connected tone generators with your feet (especially convenient for playing single note bass parts). This template lets you play/control the chord root in Style playback with a MIDI pedal unit.
MIDI Pedal2	This template lets you play the bass part for Style playback by using a MIDI pedal unit.
MIDI OFF	No MIDI signals are sent or received.

## System—MIDI System Settings

The explanations here apply when you call up “System” display in step 2 on [page 121](#).

Clock	<p>Determines whether the instrument is controlled by its own internal clock (“Internal”) or a MIDI clock (“MIDI,” “USB1,” “USB2,” and “Wireless LAN”) received from an external device. “Internal” is the normal Clock setting when the instrument is being used alone or as a master keyboard to control external devices. If you are using the instrument with an external sequencer, MIDI computer, or other MIDI device, and you want to synchronize it to that device, set this parameter to the appropriate setting: “MIDI,” “USB1,” “USB2,” or “Wireless LAN.” In this case, make sure that the external device is connected properly (e.g., to the instrument’s MIDI IN terminal), and that it is properly transmitting a MIDI clock signal. When this is set for control by an external device (“MIDI,” “USB1,” “USB2,” or “Wireless LAN”), the Tempo is indicated as “EXT.” in the Tempo display.</p> <p> <b>NOTE</b> If the Clock is set to something other than “Internal,” the Style, Song, Metronome and Tempo cannot be controlled by the buttons on this instrument.</p> <p> <b>NOTE</b> “Wireless LAN” is shown only when the USB Wireless LAN adaptor (sold separately) is connected. The USB wireless LAN adaptor may not be available depending on your area.</p>	
Transmit Clock	Turns MIDI clock (F8) transmission on or off. When set to “Off,” no MIDI clock or Start/Stop data is transmitted even if a Song or Style is played back.	
Transpose MIDI Input	Determines whether or not the instrument’s transpose setting is applied to the note events received from the external device via MIDI.	
Start/Stop	Determines whether incoming FA (start) and FC (stop) messages affect Song or Style playback.	
Local Control	Turns the Local Control for each part on or off. When Local Control is set to “On,” the keyboard of the instrument controls its own (local) internal tone generator, allowing the internal Voices to be played directly from the keyboard. If you set Local to “Off,” the keyboard and controllers are internally disconnected from the instrument’s tone generator section so that no sound is output when you play the keyboard or use the controllers. For example, this allows you to use an external MIDI sequencer to play the instrument’s internal Voices, and use the instrument keyboard to record notes to the external sequencer and/or play an external tone generator.	
System Exclusive Message	Transmit	Determines whether MIDI System Exclusive messages are transmitted (On) or not (Off) from this instrument.
	Receive	Determines whether MIDI System Exclusive messages are recognized (On) or not (Off) by this instrument.
Chord System Exclusive Message	Transmit	Determines whether MIDI chord exclusive data (Chord Detect: root and type) are transmitted (On) or not (Off) from this instrument.
	Receive	Determines whether MIDI chord exclusive data (Chord Detect: root and type) are recognized (On) or not (Off) by this instrument.

# Transmit—MIDI Transmit Channel Settings

The explanations here apply when you call up the “Transmit” display in step 2 on [page 121](#). This determines which MIDI channel is used for each part when MIDI data is transmitted from this instrument.

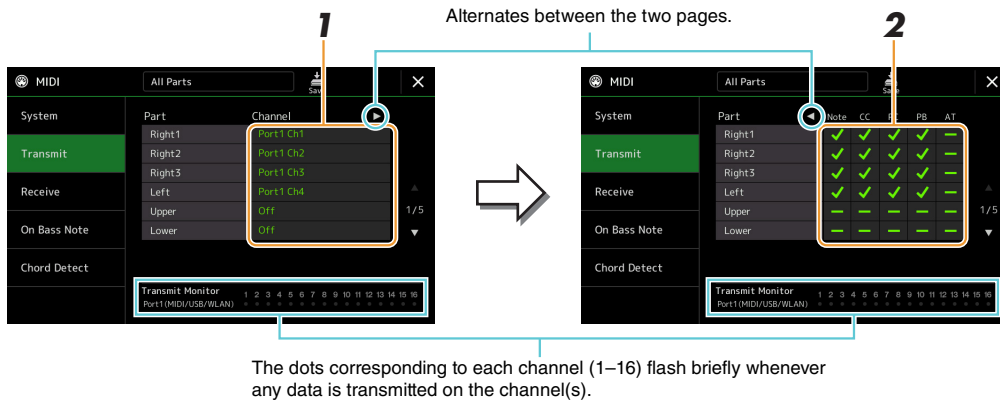

## 1 For each Part, select the MIDI Transmit Channel over which the MIDI data of the corresponding Part is to be transmitted.

With the exception of the two parts below, the configuration of the parts is the same as those already explained elsewhere in the Owner’s Manual.

- **Upper:** A keyboard part played on the right side of the keyboard from the Split Point for the Voices (RIGHT 1, 2, and 3).
- **Lower:** A keyboard part played on the left side of the keyboard from the Split Point for the Voices. This is not affected by the on/off status of the [ACMP] button.

**NOTE**

If the same transmit channel is assigned to several different parts, the transmitted MIDI messages are merged to a single channel—resulting in unexpected sounds and possible glitches in the connected MIDI device.

**NOTE**

Preset Songs cannot be transmitted even if the proper Song channels 1–16 are set to be transmitted.

## 2 Touch [▶] to call up the other page, and then select which MIDI messages are to be transmitted for each Part.

The following MIDI messages can be set on the Transmit/Receive display.

- **Note** (Note events) ..... [page 83](#)
- **CC** (Control Change) ..... [page 83](#)
- **PC** (Program Change) ..... [page 83](#)
- **PB** (Pitch Bend) ..... [page 83](#)
- **AT** (After Touch) ..... [page 83](#)

## Receive—MIDI Receive Channel Settings

The explanations here apply when you call up the “Receive” display in step 2 on [page 121](#). This determines which Part is used for each MIDI channel when the MIDI data is recognized by this instrument.

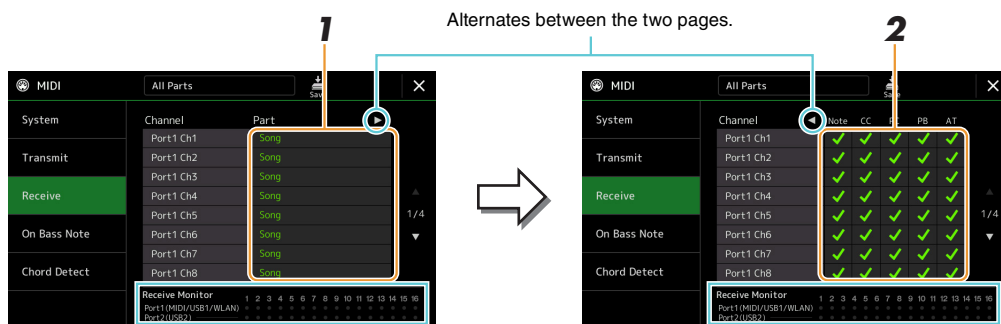

The dots corresponding to each channel (1–16) flash briefly whenever any data is received on the channel(s).

### 1 For each Channel, select the Part which is to handle the MIDI data of the corresponding channel received from the external MIDI device.

When connecting via USB, MIDI data of 32 channels (16 channels x 2 Ports) can be handled by this instrument. With the exception of the two parts below, the configuration of the parts is the same as those already explained elsewhere in the Owner’s Manual.

- **Keyboard:** The received note messages control the instrument’s keyboard performance.
- **Extra Part 1–5:** These five parts are specially reserved for receiving and playing MIDI data. Normally, these parts are not used by the instrument itself.

### 2 Touch [▶] to call up the other page, and then select which MIDI messages are to be received for each Channel.

#### MIDI transmission/reception via the USB terminal, Wireless LAN, and MIDI terminals

The relationship between the MIDI terminals, Wireless LAN and the [USB TO HOST] terminal which can be used for transmitting/receiving 32 channels (16 channels x 2 ports) of the MIDI messages is as follows:

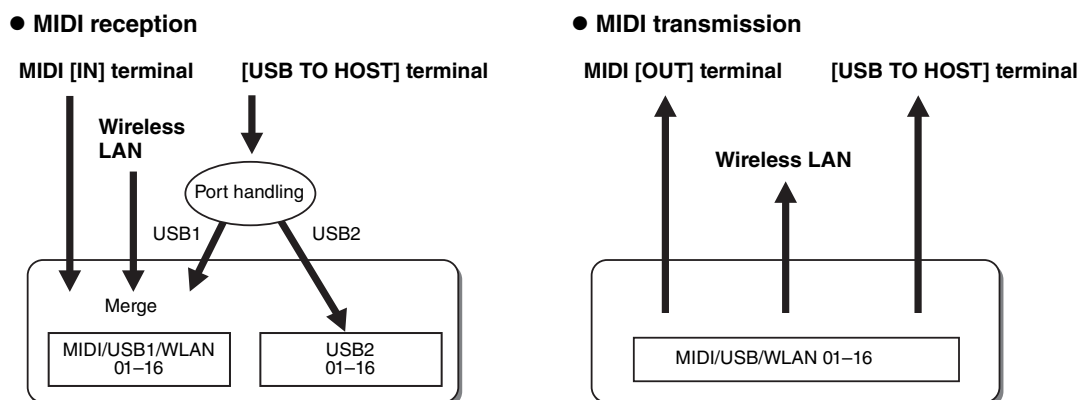

#### NOTE

The USB wireless LAN adaptor (sold separately) may not be available depending on your area.



## On Bass Note—Setting the Bass Note for Style Playback via MIDI

The explanations here apply when you call up “On Bass Note” display in step 2 on [page 121](#). The settings here let you determine the bass note for Style playback, based on the note messages received via MIDI. The note on/off messages received at the channel(s) set to on are recognized as the bass notes of the chords for Style playback. The bass note will be detected regardless of the [ACMP] or Split Point settings. When several channels are simultaneously set to on, the bass note is detected from merged MIDI data received over the channels.

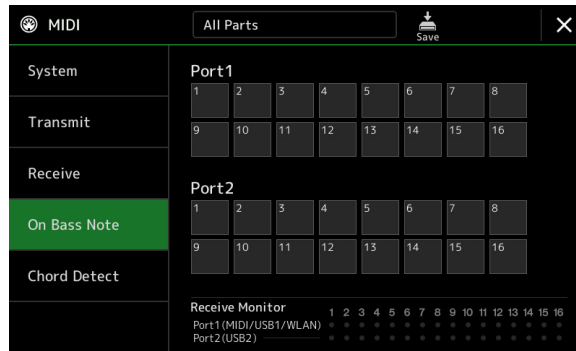

Touch the desired channel number to enter the checkmark. Touch the same location again to remove the checkmark.

## Chord Detect—Settings for Chords used in Style Playback via MIDI

The explanations here apply when you call up “Chord Detect” display in step 2 on [page 121](#). The settings here let you determine the chord type for Style playback, based on the note messages received via MIDI. The note on/off messages received at the channel(s) set to on are recognized as the notes for detecting chords in Style playback. The chords to be detected depend on the fingering type. The chord types will be detected regardless of the [ACMP] or split point settings. When several channels are simultaneously set to on, the chord type is detected from merged MIDI data received over the channels.

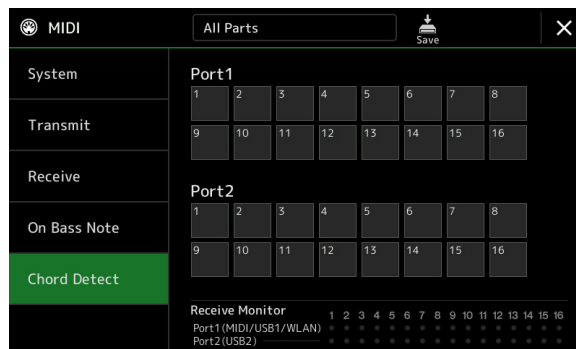

Touch the desired channel number to enter the checkmark. Touch the same location again to remove the checkmark.

## Contents

Wireless LAN Settings .....	126
• Infrastructure Mode .....	126
• Access Point Mode .....	127
Making the Time Settings .....	128

## Wireless LAN Settings

By using a USB wireless LAN adaptor (sold separately), you can connect the PSR-SX900/SX700 with an iPhone/iPad via a wireless network. For general operating instructions, refer to the “Smart Device Connection Manual for iOS” on the website. This section covers only operations that are specific to the PSR-SX900/SX700. Before starting operations, make sure that the USB wireless LAN adaptor is connected to the [USB TO DEVICE] terminal and call up the setup display via [MENU] → [Wireless LAN].

For information about the compatible smart devices and application tools, access the following page:  
<https://www.yamaha.com/kbdapps/>

### Infrastructure Mode

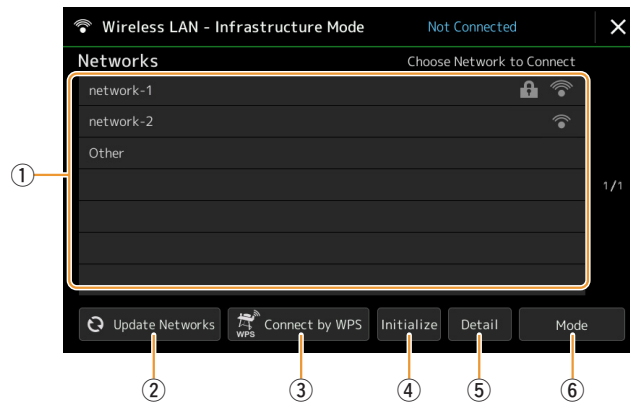

①	Networks	<p><b>Connecting to a network listed on the display:</b>          From the Networks listed on the display, select the desired one. For a network having a lock icon (🔒), you need to enter the password and touch [Connect]; for a network without a lock icon, you can connect the network only by selecting it.</p> <p><b>Manual Setup:</b>          Touch [Other] displayed at the very end of the list to call up the Manual Setup display, for making SSID, security, and password settings. After entering them, touch [Connect] on the Manual Setup display to connect to the network.</p>
②	Update Networks	Updates the Network List on the display.

③	Connect by WPS	Connects this instrument to the network via WPS. After touching [Yes] in the window called up by touching here, press the WPS button of the desired wireless LAN access point within two minutes.  <b>NOTE</b> Make sure that your access point supports WPS. About the confirmation and changes in the access point settings, refer to the manual of the access point.
④	Initialize	Initializes the connection setup to the default factory status.
⑤	Detail	For setting detailed parameters such as the static IP address. After setting, touch [OK].
⑥	Mode	Switches to the Access Point mode.

When the connection is done successfully, “Connected” is shown at the top of the display, and one of the icons shown below appears indicating the signal strength.



When the PSR-SX900/SX700 is in infrastructure mode and the network is set, the wireless LAN is automatically re-connected only in the following cases.

- When turning on the instrument
- While the Wireless LAN display is shown
- While the Time display is shown

If the connection is lost, call up the Wireless LAN display via [MENU] → [Wireless LAN].

## Access Point Mode

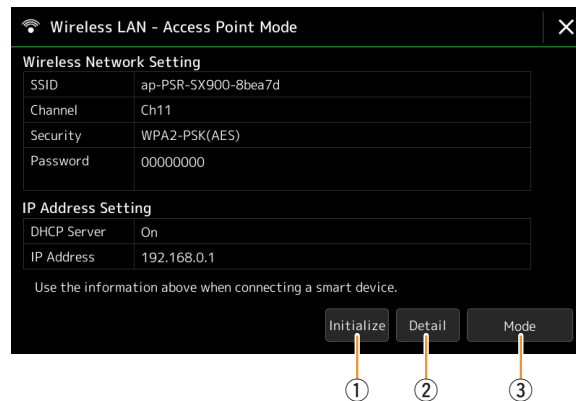

①	Initialize	Initializes the connection setup to the default factory status.
②	Detail	For setting detailed parameters. <ul style="list-style-type: none"> <li>• <b>1/3 page:</b> Sets the SSID, security, password, and channel.</li> <li>• <b>2/3 page:</b> Sets the IP address and other related parameters.</li> <li>• <b>3/3 page:</b> Enters the Host name or shows MAC address, etc.</li> </ul>
③	Mode	Switches to the Infrastructure mode.

## Making the Time Settings

You can make the time-related settings on the display called up via [MENU] → [Time]. The time is shown at the upper-right corner of the Home display.

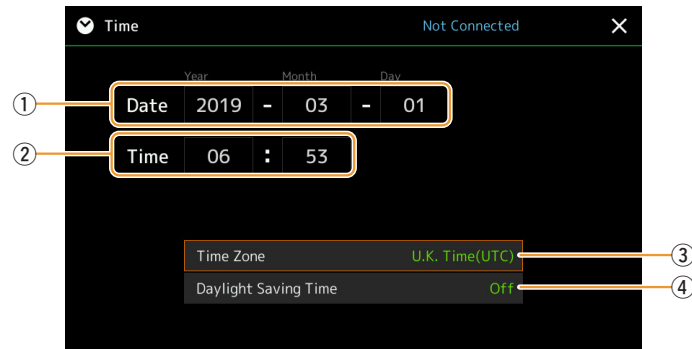

The date and time are set automatically when the instrument is connected to the network. This is available only if the USB Wireless LAN adaptor is connected to the instrument, and the wireless LAN mode setting is set to Infrastructure mode ([page 126](#)).

①	Date	Indicates the date.
②	Time	Indicates the time.
③	Time Zone	Selects the time zone.
④	Daylight Saving Time	Turns daylight-saving time on or off.

When the PSR-SX900/SX700 is in infrastructure mode (in wireless LAN settings), the connection status is shown at the top of the display, the same as in the Wireless LAN display.

## Contents

Speaker/Connectivity (PSR-SX900), Speaker (PSR-SX700)	129
Touch Screen/Display	130
Parameter Lock	130
Storage—Formatting the Drive	130
System	131
Factory Reset/Backup	132
• Factory Reset—Restoring the Factory Programmed Settings	132
• Backup/Restore—Saving and Recalling All Data and Settings as a Single File	132
• Setup Files—Saving and Loading	133

This section covers the general settings that affect the entire instrument, as well as detailed settings for specific functions. It also explains data reset functions and storage media control, such as disk formatting. The operation display can be called up via [MENU] → [Utility].

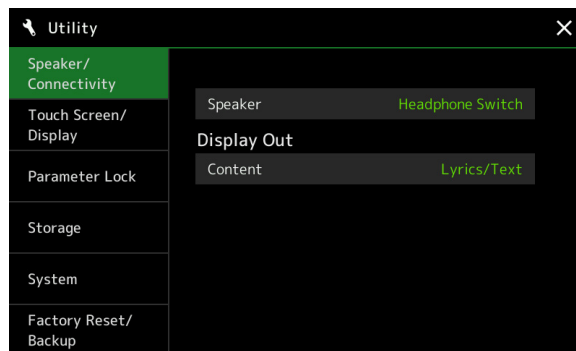

## Speaker/Connectivity (PSR-SX900), Speaker (PSR-SX700)

Speaker		<p>Determines how the sound is output to the speaker of this instrument.</p> <ul style="list-style-type: none"> <li>• <b>Headphone Switch:</b> Speaker sounds normally, but is cut off when headphones are inserted to the [PHONES] jack.</li> <li>• <b>On:</b> Speaker sound is always on.</li> <li>• <b>Off:</b> Speaker sound is off. You can only hear the instrument sound via the headphones or an external device connected to the AUX OUT jacks.</li> </ul>
Display Out (PSR-SX900)	Content	<p>Determines the output contents via a USB display adaptor when it is connected.</p> <ul style="list-style-type: none"> <li>• <b>Lyrics/Text:</b> Only the Song lyrics or text files (whichever you used last time) are output, regardless of the display currently shown on the instrument.</li> <li>• <b>Mirroring:</b> The display currently shown on the instrument is output.</li> </ul> <p><b>NOTE</b></p> <p>The instrument does not necessarily support all commercially available USB display adaptors. For a list of compatible USB display adaptors, visit the following website:  <a href="https://download.yamaha.com/">https://download.yamaha.com/</a></p>

## Touch Screen/Display

### Page 1/2

Touch Screen	Sound	Determines whether or not touching the display will trigger the click sound. When this is set to “Speaker only,” the sound is triggered by touching and is output to the speaker, but not to the MAIN OUTPUT jacks and the PHONES jack.
	Calibration	For calibrating the display when it does not respond properly to your touching. (Normally, this need not be set, since it is calibrated by factory default.) Touch here to call up the Calibration display, and then touch the center of the plus marks (+) in order.
Brightness	Screen	Adjusts the brightness of the main display.
	Button Lamps	Adjusts the brightness of the button lamps.

### Page 2/2

Display	Pop-up Display Time	Determines the time that elapses before the pop-up windows close. Pop-up windows appear when you press buttons such as TEMPO, TRANSPOSE or UPPER OCTAVE, etc. When “Hold” is selected here, the pop-up window is shown until you close it.
	Transition Effect	Turns on or off the Transition Effect which is applied when the display is changed.
File Selection	Time Stamp	Determines whether the time stamp of a file is shown on the User tab of the File Selection display or not.   <b>NOTE</b> The time can be set on the display called up via [MENU] → [Time]. For details, refer to <a href="#">page 128</a> .
	Dial Operation	Determines whether or not a file is loaded instantly when it is selected with the Dial. The following are the options. <ul style="list-style-type: none"><li>• <b>Select:</b> A file is loaded with selecting operation.</li><li>• <b>Move Cursor Only:</b> A file is not actually loaded until the [ENTER] button is pressed. A cursor appears to indicate the current selection.</li></ul>

## Parameter Lock

This function is used to “lock” specific parameters (effect, split point, etc.) to make them selectable only via the panel control—in other words, instead of being changed via Registration Memory, One Touch Setting, Playlist, or Song and sequence data.

To lock the desired parameter group, touch the corresponding box to enter the checkmark. To unlock the parameter, touch the box again.

### NOTE

For details on which parameters belong to each group, refer to the Data List (Parameter Chart) on the website.

## Storage—Formatting the Drive

This lets you execute the Format operation or check the memory capacity (approximate value) of the internal User drive or the USB flash drive connected to the [USB TO DEVICE] terminal.

To format the internal User drive or the connected USB flash drive, touch the name of the desired drive to be formatted in the device list, then touch [Format].

### **NOTICE**

The Format operation deletes any previously existing data. Make sure that the User drive or the USB flash drive you are formatting does not contain important data. Proceed with caution, especially when connecting multiple USB flash drives.

## Page 1/2

Version	Indicates the firmware version of this instrument. Yamaha may from time to time update firmware of the product without notice for improvement in functions and usability. To take full advantage of this instrument, we recommend that you upgrade your instrument to the latest version. The latest firmware can be downloaded from the website below: <a href="http://download.yamaha.com/">http://download.yamaha.com/</a>
Hardware ID	Indicates the hardware ID of this instrument.
Licenses	Touch here to call up the software license information.
Copyright	Touch here to call up copyright information.
Language	Determines the language used in the display for menu names and messages. Touch this setting to call up the language list, then select the desired one.
Owner Name	For inputting your name which appears in the opening display (called up when the power is turned on). Touch here to call up the Character Entry window, then input your name.
Auto Power Off	For setting the amount of time that elapses before the power is turned off by the Auto Power Off function. Touch this to call up the list of settings, then select the desired one. To disable Auto Power Off, select "Disabled" here.

## Page 2/2

Voice Guide	Determines whether or not Voice Guide is used (On/Off), when USB flash drive containing the Voice Guide (audio) file is properly connected to this instrument.
Voice Guide Controller	By holding the controller set here and then pressing the panel button or touching the item on the display, you can hear the corresponding name (with no execution of the function).
Voice Guide Volume	Adjusts the volume of Voice Guide.
Voice Guide Sound	Determines where the Voice Guide Sound is output. <ul style="list-style-type: none"> <li>• <b>On:</b> The sound is output to the speakers, headphones, and the MAIN OUTPUT jacks.</li> <li>• <b>Speaker Only:</b> The sound is output only to the speakers.</li> </ul> <p> <b>NOTE</b> (PSR-SX900) Even if this setting is "Speaker Only," it has priority when the output destination of the Voice Guide Sound is set to Sub1 or Sub2 on the Line Out display.</p>

To use Voice Guide, you need to download the Voice Guide (audio) file from the Yamaha website, and save it to USB flash drive, which you then connect to this instrument. For information on using Voice Guide, refer to the Voice Guide Tutorial Manual (simple text file).

The Voice Guide (audio) file and the Voice Guide Tutorial Manual are available on the website.

Please access the following URL, select your country, then go to the "Documents and Data" page, and then search by keyword "PSR-SX900" or "PSR-SX700":

<http://download.yamaha.com/>

## Factory Reset/Backup

### Factory Reset—Restoring the Factory Programmed Settings

On page 1/2, checkmark the boxes of the desired parameters then touch [Factory Reset] to initialize the settings of the parameters which are checkmarked.

System	Restores the System Setup parameters to the original factory settings. Refer to “Parameter Chart” in the Data List for details about which parameters belong to the System Setup.
MIDI	Restores the MIDI settings including the MIDI templates saved in the internal User memory to the original factory status.
User Effect	Restores the User Effect settings including the following data to the original factory settings. <ul style="list-style-type: none"><li>• User Effect types (page 106)</li><li>• User Master EQ types (page 103)</li><li>• User Master Compressor types (page 108)</li><li>• (PSR-SX900) User Vocal Harmony/Synth Vocoder types (pages 96, 100)</li><li>• User microphone/guitar settings (page 93)</li></ul>
Registration	Turns off all the REGISTRATION MEMORY [1]–[8] lamps, indicating that no Registration Memory Bank is selected although all the Bank files are maintained. In this status, you can create Registration Memory setups from the current panel settings.
Favorite	Removes all Styles or Voices from the Favorite tab (page 7) on the File Selection display.
Live Control	Restores all settings in the Live Control display (page 117) to the original factory settings.

### Backup/Restore—Saving and Recalling All Data and Settings as a Single File

On page 2/2, you can back up all data saved in the User drive (except Expansion Voices/Styles) and all settings of the instrument to a USB flash drive as a single file named “PSR-SX900.bup” or “PSR-SX700.bup.”

Before calling up the display, you need to make all desired settings on the instrument.

Touching [Backup] saves the backup file to the root directory of the USB flash drive.

Touching [Restore] calls up the backup file and all data and settings are replaced.

If you want to include audio files, enter a checkmark to the “Include Audio files” beforehand.

#### NOTE

Before using a USB flash drive, be sure to read “Connecting USB Devices” in the Owner’s Manual.

#### NOTE

- You can back up User data such as Voice, Song, Style, and Registration Memory by copying them individually to a USB flash drive on the File Selection display.
- If the total size of the target data for backup exceeds 3.9 GB (excluding Audio files), the backup function is not available. If this happens, back up the User data by copying the items individually.

#### **NOTICE**

**Completing the backup/restore operation may take a few minutes. Do not turn off the power during backup or restoring. If you turn off the power during backup or restoring, data may be lost or damaged.**



## Setup Files—Saving and Loading

For the items below, you can save your original settings to the User drive or the USB flash drive as a single file for future recall. If you want to save the setup file to the USB flash drive, make sure to connect the USB flash drive to the [USB TO DEVICE] terminal beforehand.

### NOTE

Before using a USB flash drive, be sure to read “Connecting USB Devices” in the Owner’s Manual.

**1** Make desired settings on the instrument, then call up page 2/2 of the Factory Reset/Backup display.

**2** Touch [Save] of the desired item.

System	Parameters set on the various displays such as “Utility” are handled as a single System Setup file. Refer to the Data List (Parameter Chart) on the website for details on which parameters belong to System Setup.
MIDI	The MIDI settings including the MIDI templates on the internal User memory are handled as a single MIDI Setup file.
User Effect	The User Effect settings including the following data can be managed as a single file. <ul style="list-style-type: none"><li>• User Effect types (page 106)</li><li>• User Master EQ types (page 103)</li><li>• User Master Compressor types (page 108)</li><li>• (PSR-SX900) User Vocal Harmony/Synth Vocoder types (pages 96, 100)</li><li>• User microphone settings (page 93)</li></ul>

**3** Select the desired destination to save the Setup file, then touch [Save Here].

Assign the name if necessary, then touch [OK] to save the file.

### To call up the setup file:

Touch [Load] of the desired item, then select the desired file.

You can restore the factory programmed status by selecting the Setup file in the “Preset” tab.

### Contents

Installing Expansion Pack Data from a USB Flash Drive .....	134
Saving the Instrument Info File to a USB Flash Drive .....	135
Restoring the Pre-installed Expansion Contents .....	135

Installing Expansion Packs lets you add a variety of optional Voices and Styles to the “Expansion” folder in the User drive. This section covers the operations which may be necessary to add new contents to the instrument.

## Installing Expansion Pack Data from a USB Flash Drive

The file which contains the bundled Expansion Packs (“\*\*\*.ppi” or “\*\*\*.cpi”) to be installed to the instrument is referred to as a “Pack Installation file.” Only one Pack Installation file can be installed to the instrument at a time. If you want to install multiple Expansion Packs, bundle the packs together on your computer by using the “Yamaha Expansion Manager” software. For information on how to use the software, refer to the “Yamaha Expansion Manager Owner’s Manual” on the website.

### NOTICE

You will need to restart the instrument after installation has been completed. Make sure to save all data currently being edited beforehand, otherwise it will be lost.

### NOTE

If an Expansion Pack already exists, you can overwrite it with the new one on step 4 below. You do not need to delete the existing data in advance.

- 1** Connect the USB flash drive in which the desired Pack Installation file (“\*\*\*.ppi” or “\*\*\*.cpi”) is saved to the [USB TO DEVICE] terminal.
- 2** Call up the operation display via [MENU] → [Expansion].
- 3** Touch [Pack Installation] to call up the File Selection display.
- 4** Select the desired Pack Installation file.
- 5** Follow the on-display instructions.

This installs the selected Pack data to the “Expansion” folder in the User drive.

### NOTE

If you want to delete the Expansion Pack data from the instrument, format the User drive (page 130). Note that doing so will delete all other data in the User drive.

### Song, Style or Registration Memory containing Expansion Voices or Styles

Song, Style or Registration Memory containing any Expansion Voices or Styles will not sound properly or cannot be called up, if the Expansion Pack data does not exist in the instrument.

We recommend that you write down the name of the Expansion Pack when you create the data (Song, Style or Registration Memory) using Expansion Voices or Styles, so that you can easily find and install the Expansion Pack when necessary.

## Saving the Instrument Info File to a USB Flash Drive

If you use the “Yamaha Expansion Manager” software to manage the Pack data, you may need to retrieve the Instrument Info file from the instrument as described below. For information on how to use the software, refer to the accompanying manual.

- 1** Connect the USB flash drive to the [USB TO DEVICE] terminal.
- 2** Call up the operation display via [MENU] → [Expansion].
- 3** Touch [Export Instrument Info].
- 4** Follow the on-display instructions.

### NOTE

Before using a USB flash drive, be sure to read “Connecting USB Devices” in the Owner’s Manual.

This saves the Instrument Info file to the root directory in the USB flash drive. The saved file is named “PSR-SX900\_InstrumentInfo.n27” or “PSR-SX700\_InstrumentInfo.n27.”

## Restoring the Pre-installed Expansion Contents

When you have installed an Expansion Pack which you purchased or created to the instrument, the Pre-installed Expansion contents are overwritten and lost. However, you can restore the Pre-installed contents.

### **NOTICE**

The instrument will be restarted automatically after restoration has been completed. Make sure to save all data currently being edited beforehand, otherwise it will be lost.

### NOTE

- The currently installed Pack will be deleted from the instrument when you restore the Pre-installed Expansion Contents.
- If you want to use Pre-installed Expansion Contents and other packs at the same time, obtain the Pack data of Pre-installed Expansion Contents from the product website, and then bundle the desired packs together by using the “Yamaha Expansion Manager” software on your computer.

- 1** Call up the operation display via [MENU] → [Expansion].
- 2** Touch [Restore Pre-installed Expansion Contents].  
A confirmation message appears.
- 3** Touch [OK] to start restoring.
- 4** Follow the on-display instructions.

This re-installs the Pre-installed Expansion contents data to the “Expansion” folder in the User drive, and then the instrument will be restarted automatically.

## Contents

Selecting the Output Destination of Each Sound (Line Out) (PSR-SX900)..... 136

## Selecting the Output Destination of Each Sound (Line Out) (PSR-SX900)

You can assign any desired part or drum/percussion instrument sound to any of the LINE OUT jacks, for independent output.

The operation display can be called up via [MENU] → [Line Out].

### Panel page

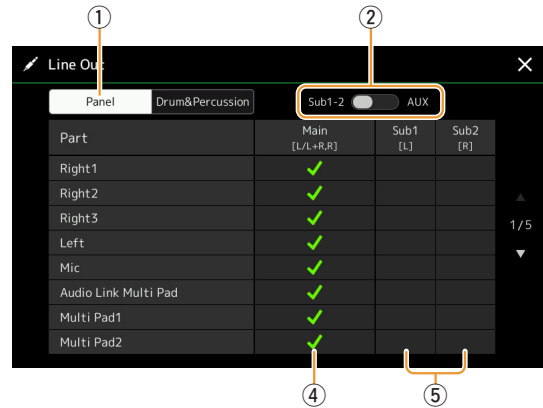
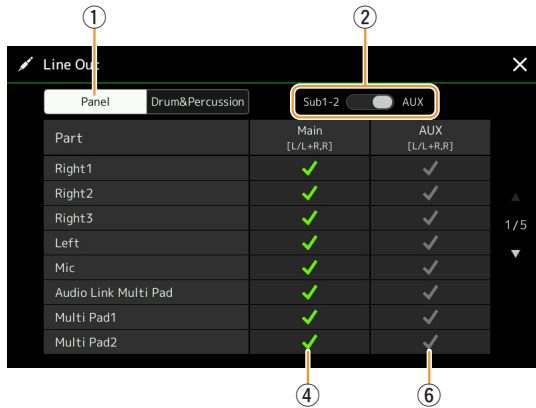

### Drum&Percussion page

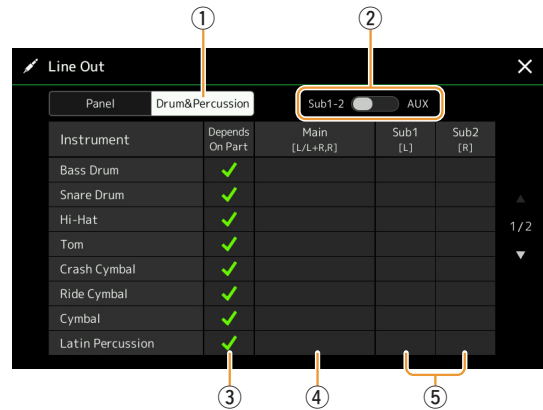
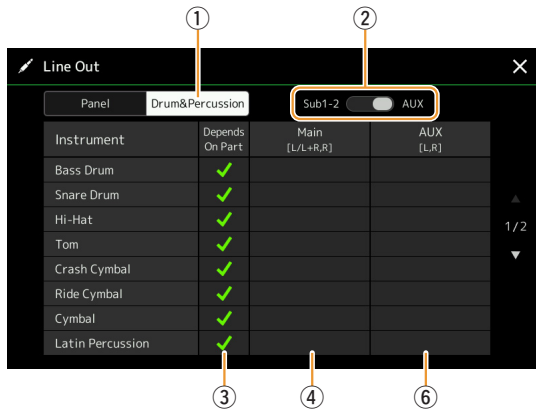

①	Panel, Drum&Percussion	Switches the displayed page: Panel parts or Drum & Percussion instruments.
②	Sub1-2, AUX Out	Switches the displayed menu: Sub1-2 or AUX. This also actually switches the role of the SUB OUTPUT 1-2 jacks or AUX OUTPUT jacks accordingly.
③	Depends on Part (Drum&Percussion page only)	When this is checked, the selected drum instrument will be output via the jacks set from the Panel page.
④	Main ([L/L+R, R])	When this is checked, the selected part/drum instruments will be output from the MAIN OUTPUT jacks, PHONES jack, and optional speaker.

⑤	Sub1–Sub2 ([L], [R])	<p>When one of these columns (jacks) is checked, the selected part/drum instruments will be output from only the selected SUB OUTPUT jack(s).</p> <p> <b>NOTE</b></p> <p>Only the Insertion Effect and Vocal Harmony effects can be applied to the sound output from the SUB OUTPUT jacks. The System Effect (Chorus, Reverb, and when the Variation Effect is set to “System”) will not be applied.</p>
⑥	AUX Out ([L/L+R, R])	<p>This is automatically checked, when “Main” is checked. The selected part/drum instruments will be output from the AUX OUTPUT jacks.</p>

**Additional information about a specific part**

As for the “Metronome” part, this includes not only the Metronome sound ([page 36](#)), but also the Touch Screen sound ([page 130](#)).

# Index

## A

Access Point Mode..... 127  
Arpeggio ..... 39, 44  
Arpeggio Hold..... 39  
Arpeggio Quantize..... 39  
Assembly ..... 24  
Assignable ..... 111, 112  
Attack..... 49, 51  
Audio Link Multi Pad..... 54  
Audio Style ..... 6  
Auto Accompaniment ..... 63  
Auto Power Off ..... 131

## B

Backup..... 132  
Block Diagram ..... 110

## C

Channel ..... 11, 64  
Channel Edit..... 24  
Channel Events ..... 74  
Chord Detect ..... 125  
Chord Fingering Type..... 8  
Chord Looper (PSR-SX900)..... 14, 15  
Chord Match ..... 53  
Chord Tutor ..... 10  
Chord Types ..... 9  
Chorus ..... 107  
Clock..... 122  
Compressor..... 108  
Copy ..... 76  
Cutoff..... 48

## D

Decay ..... 49  
Delete ..... 75  
Display..... 130  
Display Out (PSR-SX900) ..... 129  
Drum Setup ..... 30  
Dynamics..... 25  
Dynamics Control ..... 12

## E

Effect ..... 49, 105, 107  
EG (Envelope Generator)..... 49  
EQ (Equalizer) ..... 103  
Expansion Pack..... 134

## F

Factory Reset ..... 132  
Favorite..... 7  
Filter..... 48, 102  
Footage ..... 51  
Format ..... 130  
Freeze ..... 86  
Function List ..... 4

## G

Groove ..... 25  
Guide ..... 65  
Guitar Setting ..... 93

## H

Harmony ..... 44  
High Key ..... 26, 29

## I

Infrastructure Mode..... 126  
Initial Touch..... 37  
Insertion Effect ..... 49, 105  
Instrument Info File ..... 135

## J

Joystick ..... 37, 38, 48

## K

Keyboard..... 37

## L

Language ..... 131  
Line Out (PSR-SX900)..... 136  
Live Control..... 117, 118  
Local Control..... 122  
Lyrics..... 61

## M

Main Scale ..... 41, 42  
Master Compressor ..... 108  
Master EQ..... 103  
Master Tune..... 41  
MegaVoice ..... 35  
Metronome ..... 36, 137  
Mic Setting ..... 93  
Microphone ..... 93  
MIDI ..... 120  
MIDI Multi Pad Recording ..... 52  
MIDI Multi Recording ..... 68  
MIDI Settings ..... 120  
MIDI Song ..... 57  
MIDI Song Recording..... 67  
Mix ..... 76  
Mixer ..... 102  
Modulation ..... 38, 48  
Mono ..... 33, 47, 48  
Multi Pad ..... 52  
Multi Pad Creator..... 52, 54  
Music Finder ..... 91

## N

Network ..... 126  
Note Limit ..... 26, 29  
NTR (Note Transposition Rule) ..... 26, 27  
NTT (Note Transposition Table)..... 26, 27

## O

Octave ..... 39  
On Bass Note ..... 125  
Organ Flutes..... 50  
OTS Link Timing..... 12

## P

Pack Installation file..... 134  
Pan ..... 107  
Panel Setup..... 73  
Parameter Lock ..... 130  
Part EQ..... 103  
Phrase Mark Repeat..... 66  
Pitch..... 40  
Pitch Bend Range..... 38  
Play Root/Chord ..... 27  
Playback Setting (Song) ..... 65  
Playback Setting (Style) ..... 12  
Playlist ..... 91  
Poly..... 33, 47  
Portamento Time ..... 39, 47, 48  
Pre-installed Expansion Contents ..... 135  
Punch In/Out (MIDI Song) ..... 71

## Q

Quantize ..... 25, 75  
Quick Start..... 66

## R

Realtime Recording (MIDI Song)..... 69  
Realtime Recording (Multi Pad)..... 52  
Realtime Recording (Style)..... 20  
Receive Channel ..... 124  
Recording (MIDI Song)..... 67  
Registration Freeze ..... 86  
Registration Memory ..... 86  
Registration Sequence ..... 87  
Release ..... 49  
Repeat Playback ..... 58  
Re-recording..... 71  
Resonance ..... 48  
Restore ..... 132  
Reverb ..... 107  
Rotary ..... 50  
RTR (Retrigger Rule)..... 26, 29

## S

Scale Tune .....	41
Score .....	59
Search .....	89
Setup File .....	133
Song .....	57
Song List.....	57
Song Position Marker .....	85
Song Setting .....	65
Source Pattern.....	18, 19, 26
Source Root/Chord.....	27
Speaker .....	129
Step Edit (MIDI Song).....	77
Step Recording (MIDI Song) .....	77
Step Recording (Multi Pad) .....	54
Step Recording (Style) .....	23
Stop ACMP.....	12
Storage .....	130
Style.....	6
Style Creator.....	18
Style Section Reset .....	36
Style Setting .....	12
Sub Scale .....	41, 43
Synchro Stop Window .....	12
Synth Vocoder (PSR-SX900) .....	100
System.....	131
System Effect .....	105, 107
System Exclusive Message.....	122

## T

Tag (Registration Memory).....	90
Tap Tempo .....	36
Tempo .....	13
Text.....	62
Time.....	128
Touch Response .....	37
Touch Screen .....	130
Touch Screen sound .....	137
Touch Sensitivity .....	47
Transmit Channel .....	123
Transpose.....	40, 76
Tremolo .....	50
Tuning.....	39

## U

Utility.....	129
--------------	-----

## V

Variation Effect .....	105
Velocity .....	25
Version .....	131
Vibrato .....	49, 50
Vocal Harmony (PSR-SX900) .....	96
Voice.....	32
Voice Edit .....	46, 50
Voice Guide.....	131
Voice Part Setup.....	32
Voice Set .....	46
Voice Set Filter .....	39
Voice Setting .....	39
Volume .....	107

## W

Wireless LAN .....	126
--------------------	-----