

# SILENT *Cello*<sup>TM</sup>

**SVC210**

## Owner's Manual

English

*Thank you for purchasing the Yamaha SILENT Cello<sup>TM</sup>. In order to obtain the maximum performance and enjoyment from your SILENT Cello<sup>TM</sup>, we urge you to read this Owner's Manual thoroughly before using the instrument. Please keep this Owner's Manual in a safe place for later reference.*

### Contents

<b>Precautions</b> .....	<b>3</b>
<b>Main Unit/Accessories</b> .....	<b>4</b>
<b>Nomenclature</b> .....	<b>5</b>
<b>Set up</b> .....	<b>8</b>
■ Tuning and Changing the Strings .....	8
■ Setting the Knee Supports .....	11
■ About the Chest Support .....	12
■ About the End Pin .....	12
■ Attaching the Arm Support .....	12
<b>Power Supply</b> .....	<b>13</b>
■ Using Batteries .....	13
■ Supplying AC Power .....	13
<b>Putting the Instrument into the Soft Case</b> .....	<b>14</b>
<b>Specifications</b> .....	<b>15</b>

## FCC INFORMATION (U.S.A.)

### 1. IMPORTANT NOTICE: DO NOT MODIFY THIS UNIT!

This product, when installed as indicated in the instructions contained in this manual, meets FCC requirements. Modifications not expressly approved by Yamaha may void your authority, granted by the FCC, to use the product.

### 2. IMPORTANT:

When connecting this product to accessories and/or another product use only high-quality shielded cables. Cable/s supplied with this product MUST be used. Follow all installation instructions. Failure to follow instructions could void your FCC authorization to use this product in the USA.

### 3. NOTE:

This product has been tested and found to comply with the requirements listed in FCC Regulations, Part 15 for Class "B" digital devices. Compliance with these requirements provides a reasonable level of assurance that your use of this product in a residential environment will not result in harmful interference with other electronic devices. This equipment generates/uses radio frequencies and, if not installed and used according to the instructions found in the user's manual, may cause interference harmful to the operation of other electronic devices. Compliance with FCC regulations does not guarantee that interference will

not occur in all installations. If this product is found to be the source of interference, which can be determined by turning the unit "OFF" and "ON", please try to eliminate the problem by using one of the following measures:

Relocate either this product or the device that is being affected by the interference.

Utilize power outlets that are on different branch (circuit breaker or fuse) circuits or install AC line filter/s.

In the case of radio or TV interference, relocate/reorient the antenna. If the antenna lead-in is 300 ohm ribbon lead, change the lead-in to coaxial type cable.

If these corrective measures do not produce satisfactory results, please contact the local retailer authorized to distribute this type of product. If you cannot locate the appropriate retailer, please contact Yamaha Corporation of America, Electronic Service Division, 6600 Orangethorpe Ave, Buena Park, CA 90620

The above statements apply ONLY to those products distributed by Yamaha Corporation of America or its subsidiaries.

## SPECIAL MESSAGE SECTION

This product utilizes batteries or an external power supply (adaptor). DO NOT connect this product to any power supply or adaptor other than one described in the manual, on the name plate, or specifically recommended by Yamaha.

This product should be used only with the components supplied; or a cart, rack, or stand that is recommended by Yamaha. If a cart, etc., is used, please observe all safety markings and instructions that accompany the accessory product.

**SPECIFICATIONS SUBJECT TO CHANGE:** The information contained in this manual is believed to be correct at the time of printing. However, Yamaha reserves the right to change or modify any of the specifications without notice or obligation to update existing units.

Do not attempt to service this product beyond that described in the user-maintenance instructions. All other servicing should be referred to qualified service personnel.

This product, either alone or in combination with an amplifier and headphones or speaker/s, may be capable of producing sound levels that could cause permanent hearing loss. DO NOT operate for long periods of time at a high volume level or at a level that is uncomfortable. If you experience any hearing loss or ringing in the ears, you should consult an audiologist. **IMPORTANT:** The louder the sound, the shorter the time period before damage occurs.

**NOTICE:** Service charges incurred due to a lack of knowledge relating to how a function or effect works (when the unit is operating as designed) are not covered by the manufacturer's warranty, and are therefore the owner's responsibility. Please study this manual carefully and consult your dealer before requesting service.

**ENVIRONMENTAL ISSUES:** Yamaha strives to produce products that are both user safe and environmentally friendly. We sincerely believe that our products and the production methods used to produce them meet these goals. In keeping with both the letter and the spirit of the law, we want you to be aware of the following:

**Battery Notice:** This product MAY contain a small non-rechargeable battery which (if applicable) is soldered in place. The average life span of this type of battery is approximately five years. When replacement becomes necessary, contact a qualified service representative to perform the replacement.

This product may also use "household" type batteries. Some of these may be rechargeable. Make sure that the battery being charged is a rechargeable type and that the charger is intended for the battery being charged.

When installing batteries, do not mix old batteries with new, or with batteries of a different type. Batteries MUST be installed correctly. Mismatches or incorrect installation may result in overheating and battery case rupture.

**Warning:** Do not attempt to disassemble or incinerate any battery. Keep all batteries away from children. Dispose of used batteries promptly and as regulated by the laws in your area. Note: Check with any retailer of household type batteries in your area for battery disposal information.

**Disposal Notice:** Should this product become damaged beyond repair, or for some reason its useful life is considered to be at an end, please observe all local, state, and federal regulations that relate to the disposal of products that contain lead, batteries, plastics, etc. If your dealer is unable to assist you, please contact Yamaha directly.

**NAMEPLATE LOCATION:** The nameplate is located on the back of the product. The model number, serial number, power requirements, etc., are located on this plate. You should record the model number, serial number, and the date of purchase in the spaces provided below and retain this manual as a permanent record of your purchase.

Model

Serial No.

Purchase Date

92-BP

## PLEASE KEEP THIS MANUAL

## CANADA\*

THIS DIGITAL APPARATUS DOES NOT EXCEED THE "CLASS B" LIMITS FOR RADIO NOISE EMISSIONS FROM DIGITAL APPARATUS SET OUT IN THE RADIO INTERFERENCE REGULATION OF THE CANADIAN DEPARTMENT OF COMMUNICATIONS.

LE PRESENT APPAREIL NUMERIQUE N'EMET PAS DE BRUITS RADIOELECTRIQUES DEPASSANT LES LIMITES APPLICABLES AUX APPAREILS NUMERIQUES DE LA "CLASSE B" PRESCRITES DANS LE REGLEMENT SUR LE BROUILLAGE RADIOELECTRIQUE EDICTE PAR LE MINISTRE DES COMMUNICATIONS DU CANADA.

- This applies only to products distributed by Yamaha Canada Music Ltd.
- Ceci ne s'applique qu'aux produits distribués par Yamaha Canada Musique Ltée.

**Your SILENT Cello™ will give you years of reliable service if you follow the simple rules given below:**

### ■ Location

Do not expose it to the following conditions to avoid deformation, discoloration, or more serious damage.

- Direct sunlight (e.g. near a window).
- High temperatures (e.g. near a heat source, outside, or in a car during the daytime).
- Excessive humidity.
- Excessive dust.
- Strong vibrations.

### ■ Power Supply

- Turn the power switch OFF when not in use.
- If you use an AC power adaptor, unplug the adaptor from the AC outlet if not to be used for an extended period of time.
- Unplug the AC power adaptor during electric storms.
- Avoid plugging the AC power adaptor into the same AC outlet as appliances with high power consumption, such as electric heaters or ovens. Also avoid using multi-plug adaptors since these can result in reduced sound quality and possible damage.

### ■ Turn Power OFF When Making Connections

- To avoid damage to the SILENT Cello™ and other devices to which it is connected (a sound system, for example), turn the power switches of all related devices OFF prior to connecting or disconnecting audio cables.

### ■ Handling and Transport

- Never apply excessive force to the controls, connectors or other parts.
- Always unplug cables by gripping the plug firmly, not by pulling on the cable.
- Disconnect all cables before moving the unit.
- Physical shocks caused by dropping, bumping, or placing heavy objects on the unit can result in scratches and more serious damage.

### ■ Cleaning

- Clean the body and control panel with a dry soft cloth.
- A slightly damp cloth may be used to remove stubborn grime and dirt.
- Never use cleaners such as alcohol or thinner.

### ■ Electrical Interference

- This unit contains digital circuitry and may cause interference if placed too close to radio or television receivers. If this occurs, move it further away from the affected equipment.

Yamaha is not responsible for damage caused by improper handling or operation.

# Main Unit/Accessories

After opening the packaging, please check that all the parts listed below are included.

## SVC210

• Cello x 1

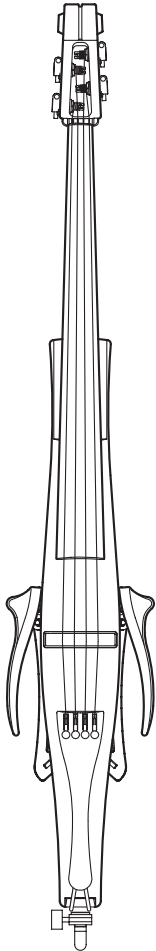

• Soft case x 1

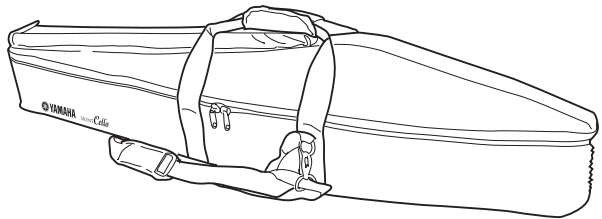

• Bridge x 1



• Chest support x 1

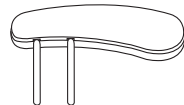

• Arm support x 1

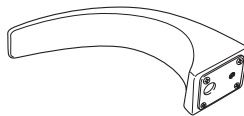

• Stereo headphones x 1



• Audio cable x 1  
(For connection of AUX IN jack)

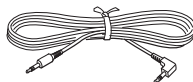

\* Power Adaptor (sold separately): Yamaha PA-3C (for use in Japan), PA-130 (for use internationally)

\* To play SVC210, you will need 2 SUM-3 (AA) size batteries.

# Nomenclature

## ● Front

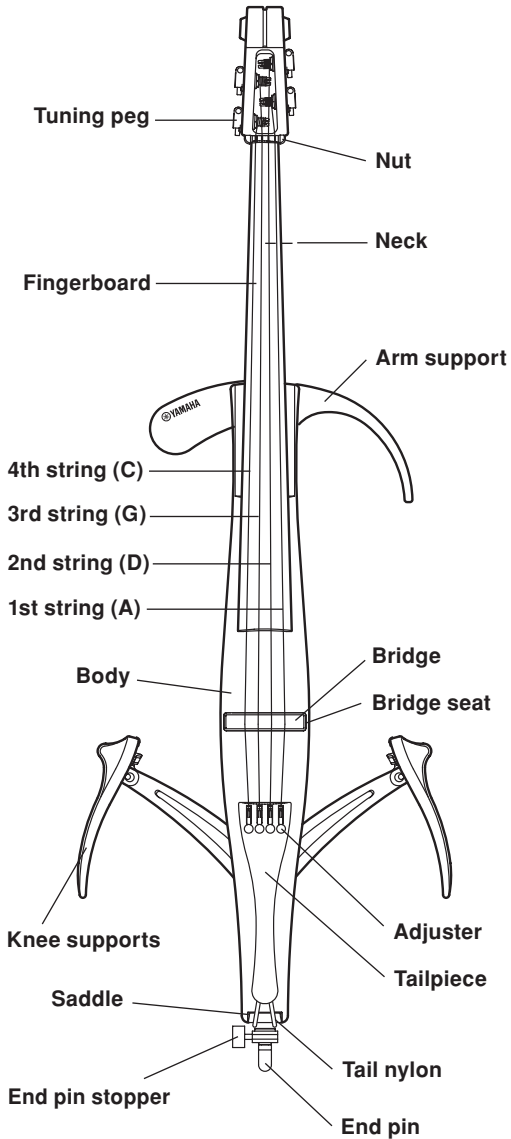

## ● Rear

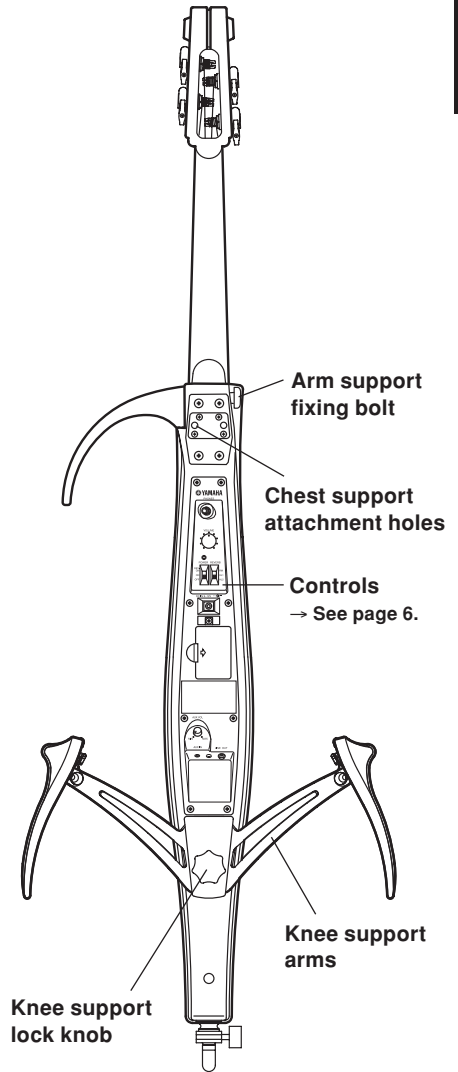

# ● Controls

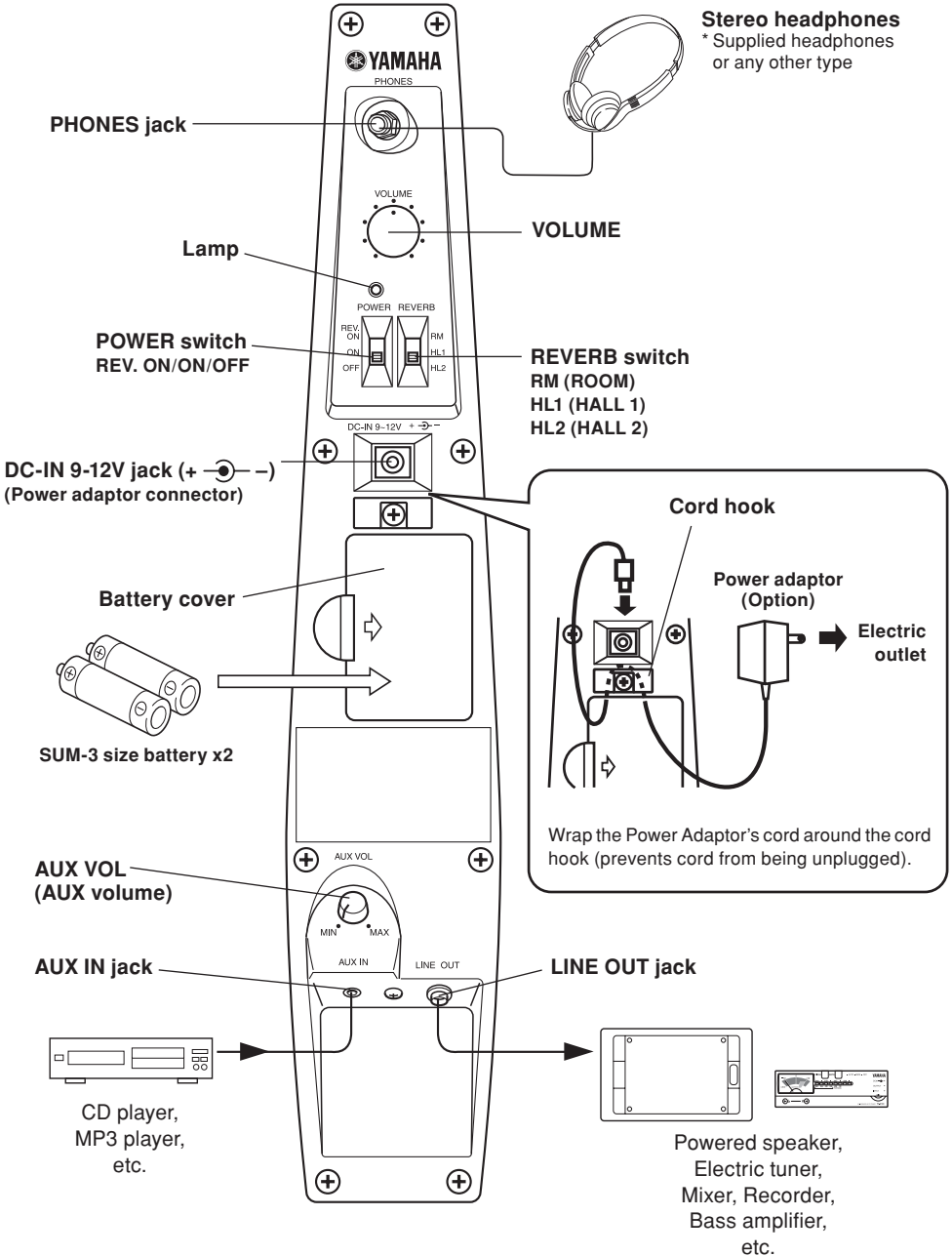

## ■ Basic Operation

- 1 Slide the POWER switch, located on the rear of the instrument, to its ON position. The lamp will light green.
- 2 Connect a pair of stereo headphones to the PHONES jack on the rear of the instrument. Make sure that the L&R sides of the headphones are positioned on the correct ears.
- 3 Rotate the VOLUME dial to the desired playing level.

## ■ Reverb Function

The SILENT Cello™ incorporates Yamaha's DSP reverb technology. Play while trying out the three types of reverb.

- 1 Slide the POWER switch to the REV. ON position, the lamp will light red, and reverb will be applied to the SILENT Cello™ sound.
- 2 Slide the REVERB switch to select one of the three reverb modes.

RM (ROOM): this reverb simulates the natural reverberation found in a room.

HL1 (HALL 1): this reverb simulates the natural reverberation found in a hall.

HL2 (HALL 2): the same reverb simulation as HL1 but with a longer decay time.

## ■ AUX IN jack

- The AUX IN jack, located on the rear of the instrument, can be used to connect an external stereo signal source to the SILENT Cello™. Connecting the audio output of a CD player, etc. to the instrument allows you to play along with the external audio source.
- The AUX IN jack's signal level can be controlled with the AUX. VOL control.

## ■ LINE OUT jack

The LINE OUT jack, located on the rear of the instrument, delivers the stereo signal of the SILENT Cello™ to external audio equipment. Using an optional stereo phone plug cable (or monaural phone plug cable) to connect the instrument to the audio input jack of external Powered speakers, mixing console, etc. to listen from external audio equipment or recording. The LINE OUT jack's signal level can be controlled with the VOLUME control.

### Caution

- When using the headphones, do not play using at high volume levels or for long periods of time. Doing so can lead to irreparable damage to your hearing.
  - Before connecting the SILENT Cello™ to any external devices, make sure that the power of all related devices is turned OFF. Set the volume level of any external audio sources to the minimum level before connecting anything. High volume settings could cause damage to the equipment and your hearing.
  - If a connection cord is unplugged while the power is ON, it may result in damage to the equipment. The sudden shock to your ears may be great, so please use with care.
  - Be careful not to step on the cord. The cord may break, equipment may be damaged, and this may cause a substantial shock to your ears.
  - The signal from the SILENT Cello™ output jacks must NEVER be returned to the AUX IN jack, either directly or through external equipment. Doing so will result in feedback which may cause damage to the internal electronics.
  - When connecting the instrument to external audio equipment, check the jack size and make sure to use a plug size that corresponds to the jack being used, and properly connect the cable to the jack.
- 
- When a powered speaker is connect to the LINE OUT jack, speakers with inadequate power ratings may distort due to the low frequencies produced by the instrument. For sufficient headroom, used powered speakers with a power rating of 50 watts or more.
  - If the sound is distorted, rotate the VOLUME dial to the left.

# Set up

## ■ Tuning and Changing the Strings

The SILENT Cello™ is shipped from the factory with the bridge unfitted. First, set up the bridge and then proceed with tuning.

As the strings get old, sound quality will gradually decrease, and it will become difficult to tune the instrument. Change the strings as soon as you think they are getting old.

- The end of the strings are sharp and can cut fingers. Use caution when changing strings.
  - When changing or adjusting strings, do not put your face close to the instrument. The string may suddenly break resulting in eye or other unexpected injuries.
- The lower side of the bridge supports the 1st string (A), the higher side supports the 4th string (C). Make sure the bridge is placed properly, then set the bridge in the bridge seat. The side of the bridge with the logo imprint should face the tailpiece.
  - Ensure that the bridge stands vertically. If it leans to one side, use both hands to adjust. Make sure that each string passes over the corresponding slits in the bridge.

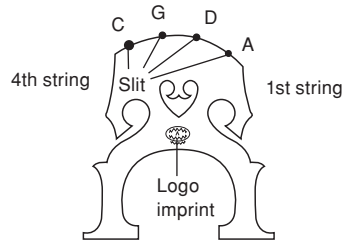

[Looking from the tailpiece]

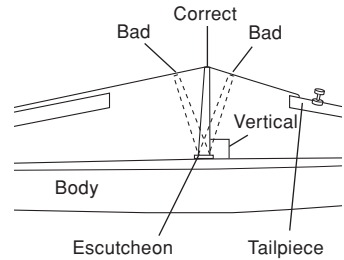
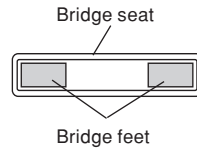

**Caution** Make sure that the strings are resting in their appropriate grooves in the bridge when playing the instrument.

Strings may come out of their grooves when adjusting the bridge or changing strings. Since the first (A) and fourth (C) strings tend to come out of their grooves easily, use your fingers to hold the strings gently in place when tuning the instrument.

**Always make sure that the bridge is standing vertically, whether the instrument is being played or stored.**

Even if the bridge is standing vertically before tuning, it may tilt during the tuning process. If so, readjust the bridge so it stands vertically.

It is very important that the bridge stands vertically. If it leans in either direction it will impair the sound and risk damaging the instrument.

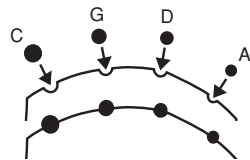

[Make sure that the strings do not come out of their grooves]

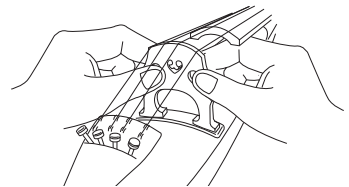

[Bridge is placed vertically]



- The strings are tuned to the following pitches. The 1st string is tuned to A, the 2nd string to D, the 3rd string to G, and the 4th string to C.

Use a piano, tuning fork, tuner, etc., and adjust the pitch of each string using the tuning pegs.

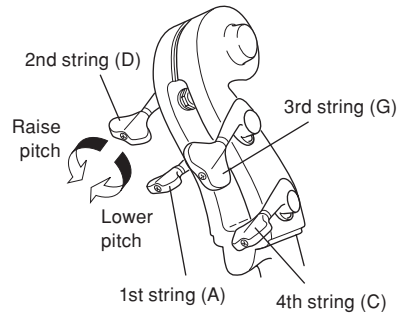

- Use the tension adjustment screw on the tuning machines to adjust the amount of pressure required to turn the tuners.

\* If the tuning machine turns with very slight pressure  
→ Rotate the adjustment screw to the right (clockwise: **A**).

\* If the tension is tight and the tuning machine is hard to turn  
→ Rotate the adjustment screw to the left (counter-clockwise: **B**).

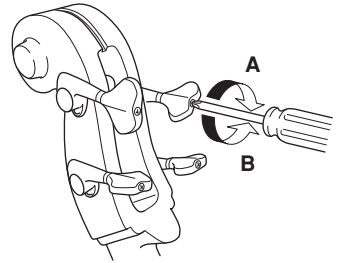

- Finally, use the adjuster to fine tune the strings.

**Caution** If the adjuster is too loose, it could produce noise while playing.

Don't loosen too much.

**Caution** Make sure that the Tail Nylon is correctly positioned on top of the Saddle.

- When the instrument is not being used, loosen the strings until the pitch drops a whole tone.
- If the instrument is not going to be used for an extended period of time, loosen the strings even more.
- Before using the instrument, make sure that the bridge is positioned vertically. Damage to the bridge and poor sound quality may result if the bridge is not properly positioned.

## ● Winding the Strings

- 1 Before you string the instrument, set the adjuster so that it is in the middle of its adjustment range. (All adjusters)
- 2 Place the ball (on the end of the string) in the notch on the adjuster. Make sure the ball is properly inserted in the adjuster's notch.

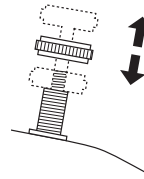

The adjuster should be set to the middle of its adjustment range.

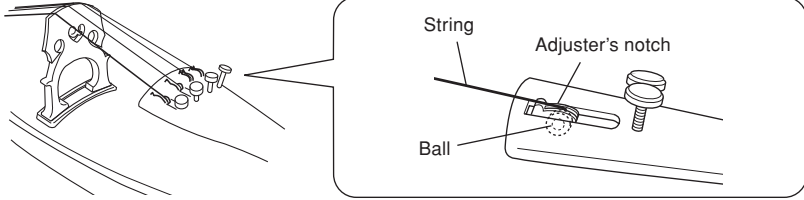

- 3 At a point about 2 cm from the string's end, bend the string at a right angle and insert the end into the hole in the tuner. While pulling the string toward the bridge to maintain string tension, turn the tuner machine to wind the string around the tuning post. Make sure the string is wound toward the base of the post as shown in the illustration below.

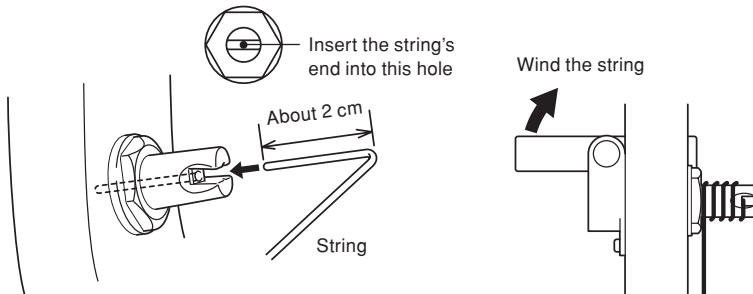

[Looking from the front]

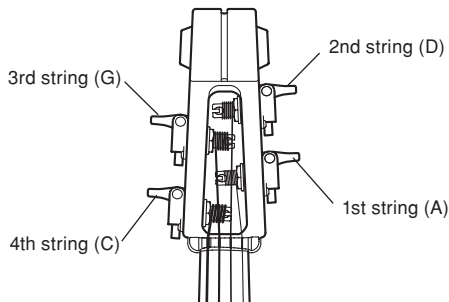

## ■ Setting the Knee Supports

The SILENT Cello™ is shipped with the knee supports folded.

Before playing, follow the procedure shown below to properly set the knee supports into position.

- 1 Loosen the knee support lock knob (about 3 turns).
  - Do not loosen the knob too much.
- 2 Slowly unfold the knee support arms on both sides of the instrument until they are fully open.
  - If the arm is caught and cannot be opened, loosen the knee support lock knob a little more.



**Use caution when expanding the knee support arms. Do not pinch your hand or fingers in the arms.**

- 3 Tighten the knee support lock knob and make sure that the knee support arms stay in place.
  - Make sure the knee supports are firmly secured in place. If they are loose, they may produce noise or cause the instrument to move about while being played.



**Don't tighten the knee support lock knob unless the knee support arms are fully opened or fully closed. Doing so may result in damage. Due to the design, tightening the lock knob when the arms are closed will not lock the arms in place.**

- 4 Slowly unfold the knee supports until they are fully open.
- 5 Slide the stoppers, located on the inner side of the knee supports, over the arm to lock the knee supports in place.

With this, setting of the knee supports is complete. To fold the knee supports simply reverse the order of the procedure shown above.

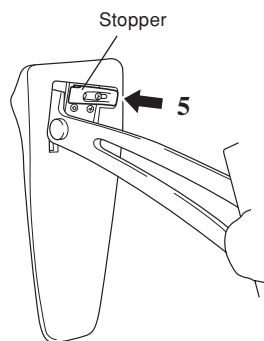
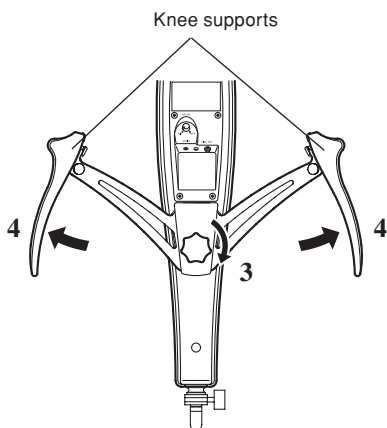
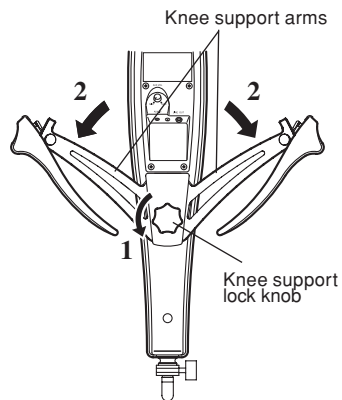

- Do not carry the instrument by the knee supports. Always carry the instrument by the neck or body.

## ■ About the Chest Support

The chest support is used to rest the cello against your body.

As shown in the illustration, insert the pins on the chest support into the attaching holes located on the back of the instrument.

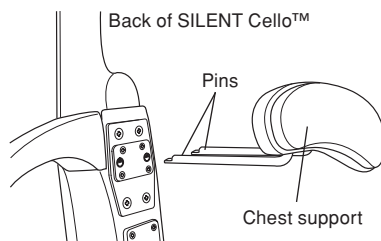

## ■ About the End Pin

Loosen the end pin stopper, extend the end pin to a comfortable length for playing and firmly tighten the end pin stopper.

A rubber foot is attached to the tip of the end pin. Removing the rubber foot exposes the pointed end pin that can be used on appropriate surfaces.

- The end pin is pointed. Please be careful when using the exposed end pin.
- Make sure the end pin stopper is secured firmly to prevent the instrument from slipping while you play.

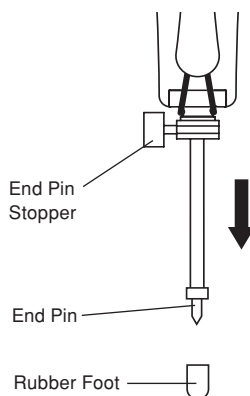

## ■ About the Arm Support

The SILENT Cello™ is shipped with the arm support detached.

Hold the arm support so that its attachment plate is parallel to the attachment position on the body. Tighten the arm support fixing bolt and secure the arm support to the body.

- Make sure the arm support is firmly attached. If it is loose, it may produce noise or cause the instrument to move about while being played.
- Do not try to remove the arm support fixing bolt from the instrument.
- Do not carry the instrument by the arm support. Always carry the instrument by the neck or body.

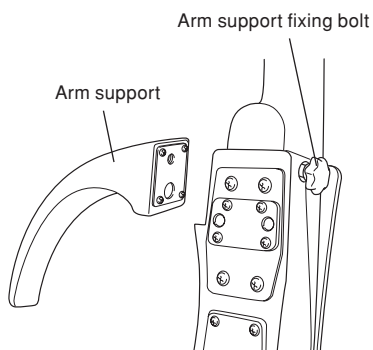

# Power Supply

The SILENT Cello™ can be operated with either battery or AC power. Always turn the power switch (OFF/ON/REV.ON) on the rear panel OFF before making AC power connections or replacing batteries.

## ■ Using Batteries

- 1 Open the battery compartment situated on the back of the SILENT Cello™.
- 2 Insert the two batteries (SUM-3 size). Take careful note of the polarity markings as shown in the illustration above, and insert the batteries.
- 3 Replace the battery compartment cover.

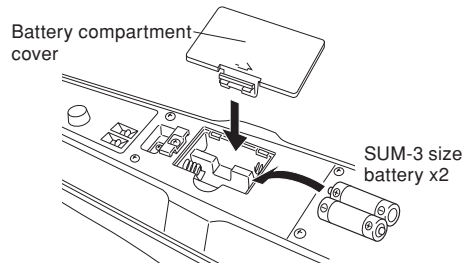

\* For customers in the Netherlands

Bij dit produkt zijn batterijen geleverd. Wanneer deze leeg zijn, moet u ze niet weggooiden maar inleveren als KCA.



Slide the **POWER** switch to the **ON** position, the lamp will light green. Slide the switch to the **REV. ON** position, the lamp will flash red. When battery power is low, the lamp's color changes to orange, the sound becomes distorted, the Reverb does not properly function, and noise becomes audible. When one of these symptoms appears, take note of the following cautions and replace the batteries.



## ⚠ Caution

- Always follow the +/- signs when inserting the batteries. Improper insertion may result in fire.
- Always replace worn batteries with a complete set of new batteries. Never mix new and old batteries. Do not mix different types of batteries (alkaline and manganese, or batteries from different manufacturers, or different types by the same manufacturer). Doing so may result in fire.
- To prevent possible damage to the unit due to battery leakage and unnecessary power drain, remove the batteries from the unit when it is not going to be used for an extended period of time.

## ■ Supplying AC Power

Power Adaptor (sold separately): Yamaha PA-3C (for use in Japan), PA-130 (for use internationally)

- 1 Plug the adaptor's DC output cable into the SILENT Cello™ DC IN 9-12V jack located on the back of the instrument, making sure the plug is firmly inserted into the jack.
- 2 Plug the AC adaptor into a convenient wall AC power socket.

- Battery power is automatically disconnected when the AC adaptor is connected.
- When the AC adaptor is used, the batteries may leak. To prevent leakage we recommend that you remove the batteries from the instrument. When the AC adaptor is used.
- When using an AC adaptor, make sure you use only the appointed compatible adaptor. The use of an incompatible adaptor may result in damage to the instrument or cause fire, etc. Please use with caution.

# About the Supplied Soft Case

The supplied soft case is designed specifically for use with the SVC210 SILENT Cello™. Attaching the protector (included in the case) allows storage and transport of the instrument with its bridge attached.

## ● Placing the cello in the case

- 1 Fold up the knee supports, and remove the chest and arm supports from the SILENT Cello™. Slide the end pin all the way into the instrument, and tighten the end pin stopper to secure.
- 2 First place the end pin end of the instrument into the soft case ①, followed by the head end of the instrument ②.

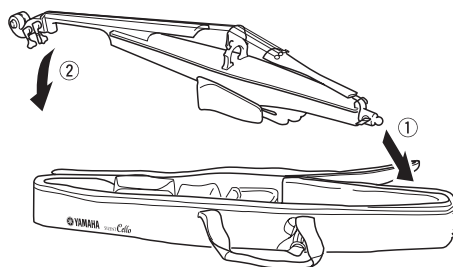

## ● Setting the Protector

- 1 Starting with the bridge side of the protector, slide it at an angle between the knee supports and case ③.
- 2 Gently push the end pin end of the protector into place ④.

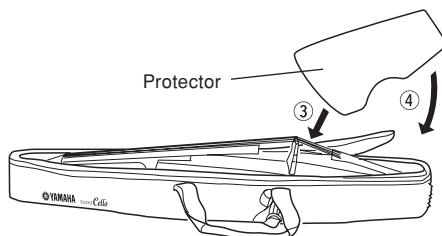

- The protector is designed to protect the instrument against light shocks while the instrument is being carried. Never expose the protector to shocks such as placing the case with the protector facing down, placing objects on top of or hitting the protector.

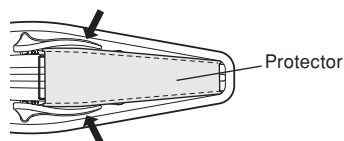

\* The protector does not guarantee against damage to parts such as the bridge, etc.

## ● The Storage Pockets

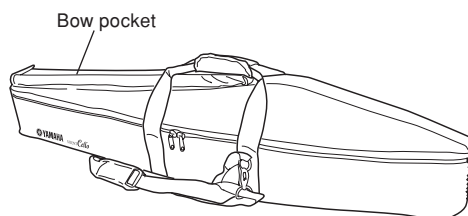
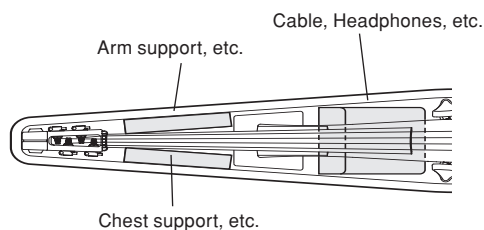

- When storing the bow in the bow pocket, always place the bow in its case.

# Specifications

<b>Neck</b>	Maple
<b>Body</b>	Spruce/Maple
<b>Fingerboard</b>	Ebony
<b>Bridge</b>	Maple (Aubert)
<b>Knee Supports/Arm Support</b>	Beech
<b>Tuning Pegs</b>	Worm Gear Type
<b>Tail Piece</b>	Adjuster 4 pieces (Wittner)
<b>Strings</b>	Ball-end type (Helicore)
<b>Sensor</b>	Piezo pick-up
<b>Connectors/Controls</b>	<ul style="list-style-type: none"><li>• Headphone Output</li><li>• AUX IN (w/Volume Control)</li><li>• LINE OUT</li><li>• Volume</li><li>• Reverb Switch (RM/HL1/HL2)</li></ul>
<b>Power</b>	<ul style="list-style-type: none"><li>• POWER Switch (OFF/ON/REV. ON)</li><li>• SUM-3 size battery x2</li></ul>
<b>Power Consumption</b>	2.5 W (with the PA-3C), 1.0 W (with the PA-130, PA-130A, B)
<b>Battery Life (Continuous Use)</b>	Using Manganese batteries <ul style="list-style-type: none"><li>• Without Reverb (POWER Switch "ON") approximately 10 hours</li><li>• With Reverb (POWER Switch "REV. ON") approximately 3 hours</li></ul> Using Alkaline batteries <ul style="list-style-type: none"><li>• Without Reverb (POWER Switch "ON") approximately 25 hours</li><li>• With Reverb (POWER Switch "REV. ON") approximately 9 hours</li></ul>
<b>String Length</b>	690 mm (27-3/8")
<b>Dimensions (setup for playing with the chest support attached)</b>	1,251 (L) x 438 (W) x 243 (H) mm 49-1/4" (L) x 17-1/4" (W) x 9-9/16" (H)
<b>Weight (with batteries and chest support)</b>	3.9kg (8 lbs. 2 oz.)

\* Design and specifications are subject to change without notice.

ヤマハ株式会社

〒430-8650 静岡県浜松市中区中沢町10-1