



DIGITAL WORKSTATION

# Tyros5

Tyros5-76 Tyros5-61

Owner's Manual

Before using the instrument, be sure to read "PRECAUTIONS" on pages 6–7.



EN

# SPECIAL MESSAGE SECTION

**PRODUCT SAFETY MARKINGS:** Yamaha electronic products may have either labels similar to the graphics shown below or molded/stamped facsimiles of these graphics on the enclosure. The explanation of these graphics appears on this page. Please observe all cautions indicated on this page and those indicated in the safety instruction section.

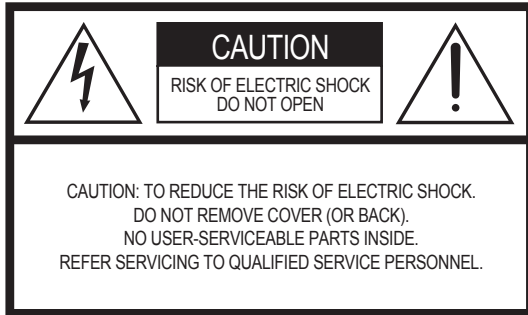

The exclamation point within the equilateral triangle is intended to alert the user to the presence of important operating and maintenance (servicing) instructions in the literature accompanying the product.



The lightning flash with arrowhead symbol, within the equilateral triangle, is intended to alert the user to the presence of uninsulated “dangerous voltage” within the product’s enclosure that may be of sufficient magnitude to constitute a risk of electrical shock.

**IMPORTANT NOTICE:** All Yamaha electronic products are tested and approved by an independent safety testing laboratory in order that you may be sure that when it is properly installed and used in its normal and customary manner, all foreseeable risks have been eliminated. DO NOT modify this unit or commission others to do so unless specifically authorized by Yamaha. Product performance and/or safety standards may be diminished. Claims filed under the expressed warranty may be denied if the unit is/has been modified. Implied warranties may also be affected.

**SPECIFICATIONS SUBJECT TO CHANGE:** The information contained in this manual is believed to be correct at the time of printing. However, Yamaha reserves the right to change or modify any of the specifications without notice or obligation to update existing units.

**ENVIRONMENTAL ISSUES:** Yamaha strives to produce products that are both user safe and environmentally friendly. We sincerely believe that our products and the production methods used to produce them, meet these goals. In keeping with both the letter and the spirit of the law, we want you to be aware of the following:

**Battery Notice:** This product MAY contain a small non-rechargeable battery which (if applicable) is soldered in place. The average life span of this type of battery is approximately five years. When replacement becomes necessary, contact a qualified service representative to perform the replacement.

**Warning:** Do not attempt to recharge, disassemble, or incinerate this type of battery. Keep all batteries away from children. Dispose of used batteries promptly and as regulated by applicable laws. Note: In some areas, the servicer is required by law to return the defective parts. However, you do have the option of having the servicer dispose of these parts for you.

**Disposal Notice:** Should this product become damaged beyond repair, or for some reason its useful life is considered to be at an end, please observe all local, state, and federal regulations that relate to the disposal of products that contain lead, batteries, plastics, etc.

**NOTICE:** Service charges incurred due to lack of knowledge relating to how a function or effect works (when the unit is operating as designed) are not covered by the manufacturer’s warranty, and are therefore the owners responsibility. Please study this manual carefully and consult your dealer before requesting service.

**NAME PLATE LOCATION:** The name plate is located on the bottom of the product. The model number, serial number, power requirements, etc., are located on this plate. You should record the model number, serial number, and the date of purchase in the spaces provided below and retain this manual as a permanent record of your purchase.

**Model** \_\_\_\_\_

**Serial No.** \_\_\_\_\_

**Purchase Date** \_\_\_\_\_

# IMPORTANT SAFETY INSTRUCTIONS

- 1 Read these instructions.
- 2 Keep these instructions.
- 3 Heed all warnings.
- 4 Follow all instructions.
- 5 Do not use this apparatus near water.
- 6 Clean only with dry cloth.
- 7 Do not block any ventilation openings. Install in accordance with the manufacturer's instructions.
- 8 Do not install near any heat sources such as radiators, heat registers, stoves, or other apparatus (including amplifiers) that produce heat.
- 9 Do not defeat the safety purpose of the polarized or grounding-type plug. A polarized plug has two blades with one wider than the other. A grounding type plug has two blades and a third grounding prong. The wide blade or the third prong are provided for your safety. If the provided plug does not fit into your outlet, consult an electrician for replacement of the obsolete outlet.
- 10 Protect the power cord from being walked on or pinched particularly at plugs, convenience receptacles, and the point where they exit from the apparatus.
- 11 Only use attachments/accessories specified by the manufacturer.
- 12 Use only with the cart, stand, tripod, bracket, or table specified by the manufacturer, or sold with the apparatus. When a cart is used, use caution when moving the cart/apparatus combination to avoid injury from tip-over.
- 13 Unplug this apparatus during lightning storms or when unused for long periods of time.
- 14 Refer all servicing to qualified service personnel. Servicing is required when the apparatus has been damaged in any way, such as power-supply cord or plug is damaged, liquid has been spilled or objects have fallen into the apparatus, the apparatus has been exposed to rain or moisture, does not operate normally, or has been dropped.



## WARNING

TO REDUCE THE RISK OF FIRE OR ELECTRIC SHOCK, DO NOT EXPOSE THIS APPARATUS TO RAIN OR MOISTURE.

(UL60065\_03)

The model number, serial number, power requirements, etc., may be found on or near the name plate, which is at the bottom of the unit. You should note this serial number in the space provided below and retain this manual as a permanent record of your purchase to aid identification in the event of theft.

**Model No.**

\_\_\_\_\_

**Serial No.**

\_\_\_\_\_

(bottom\_en\_01)

Tyros5-61

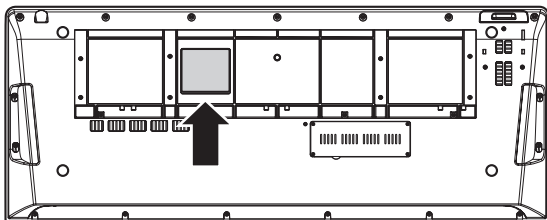

Tyros5-76

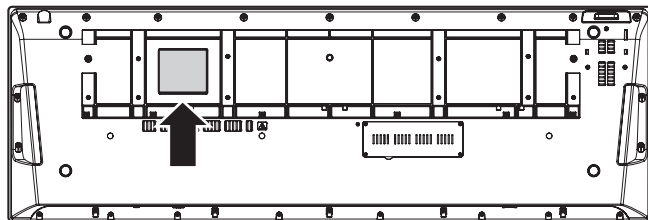

The name plate is located on the bottom of the unit.

# Contents

---

PRECAUTIONS .....	6
Included Accessories .....	9
About the Manuals .....	10
Main Features .....	11
<b>Panel Controls and Terminals</b> .....	<b>12</b>
<b>Starting Up</b> .....	<b>16</b>
Power Supply .....	16
Turning the Power On/Off .....	16
Playing the Demo .....	17
Raising the Display Panel .....	18
Changing the Display Language .....	18
Displaying the Program Version .....	19
Locking the Panel Settings (Panel Lock) .....	19
<b>Basic Operations</b> .....	<b>20</b>
Display-based Controls .....	20
Calling Up the Desired Display Instantly—Direct Access .....	23
Messages Shown in the Display .....	23
Main Display Configuration .....	24
File Selection Display Configuration .....	25
File Management .....	29
Entering Characters .....	34
Restoring the Factory-programmed Settings .....	35
Data Backup .....	35
<b>1 Voices – Playing the Keyboard –</b> .....	<b>36</b>
Playing Preset Voices .....	36
Adding Articulation Effects to Super Articulation Voices .....	40
Playing Various Organ Voices (Organ World) .....	42
Playing Ensemble Voices .....	44
Transposing the Pitch .....	46
Using the Wheels .....	47
Applying Voice Effects .....	48
Adding New Contents—Expansion Packs .....	50
<b>2 Styles – Playing Rhythm and Accompaniment –</b> .....	<b>51</b>
Playing a Style with the Auto Accompaniment .....	51
Operating Style Playback .....	53
Chords .....	55
Calling up Appropriate Panel Settings for the Current Style (One Touch Setting) .....	56
Searching for Suitable Songs for the Current Style (Repertoire) .....	57
Calling up Optimum Styles for Your Performance (Style Recommender) .....	58
Turning Each Channel of the Style On/Off .....	60
Adjusting the Volume Balance Between the Parts .....	61
Setting the Split Point .....	62
Specifying Chords with Your Right Hand while Playing Bass with Your Left Hand .....	63
<b>3 Multi Pads – Adding Musical Phrases to Your Performance –</b> .....	<b>64</b>
Playing the Multi Pads .....	64
Using the Multi Pad Synchro Start Function .....	65
Using Chord Match .....	65
Creating a New Multi Pad with WAVE files (Audio Link Multi Pad) .....	66

---



<b>4</b>	<b>Songs – Recording Your Performances as MIDI Songs –</b>	<b>68</b>
	Basic Procedure for Recording .....	68
	Playback of Songs .....	71
	Displaying Music Notation (Score).....	73
	Displaying Lyrics (Text).....	73
	Using Song Position Markers.....	74
	Turning Each Channel of the Song On/Off .....	75
<b>5</b>	<b>Audio Recorder/Player – Recording and Playing Audio Files –</b>	<b>76</b>
	Recording Your Performance as Audio .....	76
	Playing Back Audio Files .....	78
	Playback-related Operations.....	79
<b>6</b>	<b>Music Finder – Calling Up Ideal Panel Settings for Your Performance –</b>	<b>81</b>
	Selecting the Desired Record (Panel Settings).....	82
	Searching for Records (Panel Settings).....	83
	Registering a MIDI Song, Audio Song or Style to a Record .....	84
<b>7</b>	<b>Registration Memory – Saving and Recalling Custom Panel Setups –</b>	<b>85</b>
	Registering Your Panel Setups .....	85
	Saving the Registration Memory as a Bank file .....	86
<b>8</b>	<b>Microphone – Adding Harmony Vocals and Synth Vocoder to Your Singing –</b>	<b>88</b>
	Connecting a Microphone .....	88
	Using Vocal Harmony .....	89
	Using Synth Vocoder .....	91
<b>9</b>	<b>Mixing Console – Editing the Volume and Tonal Balance –</b>	<b>92</b>
	Basic Procedure.....	92
	Master Compressor .....	94
<b>10</b>	<b>Utility – Making Global Settings –</b>	<b>96</b>
	Basic Procedure.....	96
<b>11</b>	<b>Connections – Using Your Instrument with Other Devices –</b>	<b>97</b>
	Connecting a Microphone ([MIC INPUT] jack).....	97
	Connecting Audio Devices (LINE OUT jacks, AUX IN jacks) .....	97
	Connecting an External Monitor ([RGB OUT] terminal) .....	99
	Connecting Footswitches/Foot Controllers (ASSIGNABLE FOOT PEDAL jacks) .....	100
	Connecting USB Devices ([USB TO DEVICE] terminal).....	101
	Connecting to an iPhone/iPad ([USB TO DEVICE], [USB TO HOST] and MIDI terminals).....	102
	Connecting to a Computer ([USB TO HOST] terminal) .....	103
	Connecting External MIDI Devices (MIDI terminals).....	105
	<b>Appendix</b>	<b>106</b>
	Installing the Optional Speakers .....	106
	Installing the Optional Flash Memory Expansion Module .....	108
	Direct Access Chart .....	110
	Panel Button Chart.....	112
	Troubleshooting .....	115
	Specifications.....	118
	Index .....	120

# PRECAUTIONS

## PLEASE READ CAREFULLY BEFORE PROCEEDING

Please keep this manual in a safe and handy place for future reference.



### WARNING

Always follow the basic precautions listed below to avoid the possibility of serious injury or even death from electrical shock, short-circuiting, damages, fire or other hazards. These precautions include, but are not limited to, the following:

#### Power supply/Power cord

- Do not place the power cord near heat sources such as heaters or radiators. Also, do not excessively bend or otherwise damage the cord, or place heavy objects on it.
- Only use the voltage specified as correct for the instrument. The required voltage is printed on the name plate of the instrument.
- Use only the supplied power cord/plug.
- Check the electric plug periodically and remove any dirt or dust which may have accumulated on it.
- Be sure to connect to an appropriate outlet with a protective grounding connection. Improper grounding can result in electrical shock.

#### Do not open

- This instrument contains no user-serviceable parts. Do not attempt to disassemble or modify the internal components in any way. If it should appear to be malfunctioning, discontinue use immediately and have it inspected by qualified Yamaha service personnel.

#### Water warning

- Do not expose the instrument to rain, use it near water or in damp or wet conditions, place on it any containers (such as vases, bottles or glasses) containing liquids which might spill into any openings. If any liquid such as water seeps into the instrument, turn off the power immediately and unplug the power cord from the AC outlet. Then have the instrument inspected by qualified Yamaha service personnel.
- Never insert or remove an electric plug with wet hands.

#### Fire warning

- Do not put burning items, such as candles, on the unit. A burning item may fall over and cause a fire.

#### If you notice any abnormality

- When one of the following problems occur, immediately turn off the power switch and disconnect the electric plug from the outlet. Then have the device inspected by Yamaha service personnel.
  - The power cord or plug becomes frayed or damaged.
  - It emits unusual smells or smoke.
  - Some object has been dropped into the instrument.
  - There is a sudden loss of sound during use of the instrument.



### CAUTION

Always follow the basic precautions listed below to avoid the possibility of physical injury to you or others, or damage to the instrument or other property. These precautions include, but are not limited to, the following:

#### Power supply/Power cord

- Do not connect the instrument to an electrical outlet using a multiple-connector. Doing so can result in lower sound quality, or possibly cause overheating in the outlet.
- When removing the electric plug from the instrument or an outlet, always hold the plug itself and not the cord. Pulling by the cord can damage it.
- Remove the electric plug from the outlet when the instrument is not to be used for extended periods of time, or during electrical storms.

#### Location

- Do not place the instrument in an unstable position where it might accidentally fall over.
- Before moving the instrument, remove all connected cables, to prevent damage to the cables or injury to anyone who might trip over them.
- When setting up the product, make sure that the AC outlet you are using is easily accessible. If some trouble or malfunction occurs, immediately turn off the power switch and disconnect the plug from the outlet. Even when the power switch is turned off, electricity is still flowing to the product at the minimum level. When you are not using the product for a long time, make sure to unplug the power cord from the wall AC outlet.
- Use only the stand specified for the instrument. When attaching the stand or rack, use the provided screws only. Failure to do so could cause damage to the internal components or result in the instrument falling over.

#### Connections

- Before connecting the instrument to other electronic components, turn off the power for all components. Before turning the power on or off for all components, set all volume levels to minimum.
- Be sure to set the volumes of all components at their minimum levels and gradually raise the volume controls while playing the instrument to set the desired listening level.

#### Handling caution

- Do not insert a finger or hand in any gaps on the instrument.
- Never insert or drop paper, metallic, or other objects into the gaps on the panel. This could cause physical injury to you or others, damage to the instrument or other property, or operational failure.
- Do not rest your weight on, or place heavy objects on the instrument, and do not use excessive force on the buttons, switches or connectors.
- Do not use the instrument/device or headphones for a long period of time at a high or uncomfortable volume level, since this can cause permanent hearing loss. If you experience any hearing loss or ringing in the ears, consult a physician.

Yamaha cannot be held responsible for damage caused by improper use or modifications to the instrument, or data that is lost or destroyed.

Always turn the power off when the instrument is not in use.

When you are not using the instrument for a long time, make sure you unplug the power cord from the wall AC outlet.

## Notices and Information

### NOTICE

To avoid the possibility of malfunction/ damage to the product, damage to data, or damage to other property, follow the notices below.

#### ■ Handling

- Do not use the instrument in the vicinity of a TV, radio, stereo equipment, mobile phone, or other electric devices. Otherwise, the instrument, TV, or radio may generate noise. When you use the instrument along with an application on your iPad, iPhone or iPod touch, we recommend that you set "Airplane Mode" to "ON" on that device in order to avoid noise caused by communication.
- Do not expose the instrument to excessive dust or vibrations, or extreme cold or heat (such as in direct sunlight, near a heater, or in a car during the day) to prevent the possibility of panel disfiguration, damage to the internal components or unstable operation (Verified operating temperature range: 5° – 40°C, or 41° – 104°F).
- Do not place vinyl, plastic or rubber objects on the instrument, since this might discolor the panel or keyboard.
- When cleaning the instrument, use a soft cloth. Do not use paint thinners, solvents, cleaning fluids, or chemical-impregnated wiping cloths.

#### ■ Saving data

- The edited Voices, Styles, One Touch Settings, Songs, Multi Pads and MIDI settings are lost when you turn off the power of instrument without saving. It occurs also when the power is turned off by Auto Power Off function (page 17). Save the edited data to the instrument (User memory), internal hard disk drive or USB flash memory (page 29). Saving the data to USB flash memory is even more secure, since the data in the instrument may be lost due to malfunction or incorrect operation.
- To further protect against data loss through USB flash memory damage, we recommend that you save your important data onto two USB flash memories.
- You can save the data also to a computer by connecting the instrument to a computer (page 103).
- System Setup data (data other than the edited Voices, Styles, One Touch Settings, Songs, Multi Pads and MIDI settings) is automatically stored, when you change the settings in a display page and then exit from that page. However, the data is lost if you turn off the power without properly existing from the relevant display. For information about the System Setup data, refer to the Parameter Chart of the Data List on the website.

## Information

### ■ About copyrights

- Copying of the commercially available musical data including but not limited to MIDI data and/or audio data is strictly prohibited except for your personal use.
- This product incorporates and bundles computer programs and contents in which Yamaha owns copyrights or with respect to which it has license to use others' copyrights. Such copyrighted materials include, without limitation, all computer software, style files, MIDI files, WAVE data, musical scores and sound recordings. Any unauthorized use of such programs and contents outside of personal use is not permitted under relevant laws. Any violation of copyright has legal consequences. DON'T MAKE, DISTRIBUTE OR USE ILLEGAL COPIES.

### ■ About functions/data bundled with the instrument

- Some of the preset songs have been edited for length or arrangement, and may not be exactly the same as the original.
- This device is capable of using various types/formats of music data by optimizing them to the proper format music data for use with the device in advance. As a result, this device may not play them back precisely as their producers or composers originally intended.
- The bitmap fonts used in this instrument have been provided by and are the property of Ricoh Co., Ltd.
- This product can be used to import/record analog audio signals through the MIC and AUX IN input jacks, and can also record your keyboard performance and playback of MIDI song data into digital audio signals of WAV format. If you use any copyrighted material in your recording, even if you add your own performance, the copying or public playback of that material, other than for your own personal use, is strictly prohibited.
- MPEG Layer-3 audio coding technology licensed from Fraunhofer IIS and Thomson.



### Copyright Notice

The followings are the titles, credits and copyright notices for the songs pre-installed in this instrument.

#### **Achy Breaky Heart (Don't Tell My Heart)**

Words and Music by Don Von Tress

Copyright © 1991 UNIVERSAL - MILLHOUSE MUSIC

All Rights Reserved Used by Permission

#### **Beauty And The Beast**

from Walt Disney's BEAUTY AND THE BEAST

Lyrics by Howard Ashman

Music by Alan Menken

© 1991 Walt Disney Music Company and Wonderland Music Company, Inc.

All Rights Reserved Used by Permission

## Congratulations!

You are the proud owner of an extraordinary electronic keyboard.

The Yamaha Tyros5 combines the most advanced tone generation technology with state-of-the-art digital electronics and features to give you stunning sound quality with maximum musical versatility.

In order to make the most of your Tyros5's features and vast performance potential, we urge you to read the manual thoroughly while trying out the various features described. Keep the manual in a safe place for later reference.

## Included Accessories

---

- Owner's Manual (this book)
- Online Member Product Registration
  - \* The PRODUCT ID on this sheet will be needed when you fill out the online registration form.  
<https://member.yamaha.com/>
- AC Power Cord
- Music Rest, two Music Rest Brackets

The following item may be included or optional, depending on your locale.

- USB Wireless LAN Adaptor

# About the Manuals

---

This instrument has the following documents and instructional materials.

## Included Documents



### **Owner's Manual (this book)**

Provides overall explanations of the Tyros5 basic functions.



### **USB Wireless LAN Adaptor Manual**

Informs the precautions that you need to read before using the adaptor.

## Online Materials (Downloadable from the web)



### **Reference Manual (only in English, French and German)**

Explains advanced features of the instrument, such as creating original Styles, Songs and Multi Pads, and making the settings of specific parameters.



### **Data List**

Contains various important preset content lists such as Voices, Styles, Effects, as well as MIDI-related information.



### **iPhone/iPad Connection Manual (page 102)**

Explains how to connect the instrument to smart devices, such as iPhone, iPad, etc.



### **Computer-related Operations (page 103)**

Includes instructions on connecting the instrument to a computer, and operations related to transferring song data.

To obtain these materials, access the Yamaha Downloads, enter “Tyros5” to the Model Name box, then click [Search].

#### **Yamaha Downloads**

<http://download.yamaha.com/>

- Unless indicated otherwise, the illustrations and displays as shown in this manual are based on the 61-key keyboard. These are for instructional purposes only, and may appear somewhat different from those on your instrument.
- Windows is a registered trademark of Microsoft® Corporation in the United States and other countries.
- iPad, iPhone or iPod touch are trademarks of Apple Inc., registered in the U.S. and other countries.
- The company names and product names in this manual are the trademarks or registered trademarks of their respective companies.

# Main Features

## ● Extraordinarily expressive and realistic Voices

As one of the most powerful performance keyboards ever created, the Tyros5 has a comprehensive and sonically stunning set of authentic Voices, and gives you the means to play these Voices more naturally and with greater expressiveness. In particular, the instrument has new Ensemble Voices that let you convincingly recreate true multi-part ensemble playing, such as brass sections and string quartets. There are also many new and enhanced orchestral Super Articulation Voices, including trumpet, trombone and flute. Moreover, a special Organ World feature provides realistic recreation plus expressive control of some of the world's most popular organ sounds.

## ● Dynamic, professional Auto Accompaniment Styles

The Styles of the Tyros5 make it possible to perform in a wide variety of music genres with full backing band accompaniment. However, the new Audio Styles bring a fresh level of realism and expressiveness, featuring actual audio recordings of top-class studio musicians. These impart all the original feel, ambience and excitement to the drums and percussion parts of the Style, and retain the subtle nuances and grooves that are difficult to reproduce using the preset drum kits.

## ● Powerful DSP effect processing for enhancing the sound

Not only does the Tyros5 have new and high-quality effect types, including Real Distortion and Real Reverb, it provides beautifully designed panel displays, with highly intuitive controls—just like actual effect devices. These also include VCM effects that use the same technology as the professional-level processing on Yamaha's high-end mixers.

## ● Audio recording and playback

The Tyros5 lets you conveniently record your performance as audio data, and save it in WAV file format—making it easy to edit your recordings on computer as desired, and share them over the Internet, or burn your own original CDs. MP3 audio playback is also supported. Moreover, the instrument provides a variety of advanced convenient audio playback and processing functions, including Time Stretch, which lets you slow down or speed up an audio file without changing the pitch, and Pitch Shift, which allows you to change the pitch without affecting the time. Moreover, a Vocal Cancel function effectively mutes center-position vocals in audio, letting you to sing “karaoke” style with just instrumental backing.

## ● Expressive and Versatile Vocal Harmony feature—with Synth Vocoder

The enhanced Vocal Harmony 2 (VH2) processing engine delivers superior sound, lightning-fast processing and comprehensive, flexible control of the harmonies applied to your singing voice (page 89). It also has a Synth Vocoder feature, recreating that popular effect for a variety of luscious, other-worldly sounds. In addition, the rear-panel combo jack lets you conveniently connect either XLR mic cables or ¼” phone plugs.

## ● Voice expandability

The Tyros5 is an open-ended instrument that lets you continually expand the available content for your creative explorations. Featured on our special website (<http://yamahamusicsoft.com>) are many Voices, Waves, Songs and Styles (called Premium Pack data) that you can buy and load to the Tyros5. (You'll need to install the optional Flash Memory Expansion Module in order to use this additional content.)

### Compatible formats for the instrument



“GM (General MIDI)” is one of the most common Voice allocation formats. “GM System Level 2” is a standard specification that enhances the original “GM” and improves Song data compatibility. It provides for increased polyphony, greater Voice selection, expanded Voice parameters, and integrated effect processing.



XG is a major enhancement of the GM System Level 1 format, and was developed by Yamaha specifically to provide more Voices and variations, as well as greater expressive control over Voices and effects, and to ensure compatibility of data well into the future.



GS was developed by the Roland Corporation. In the same way as Yamaha XG, GS is a major enhancement of the GM specifically to provide more Voices and Drum kits and their variations, as well as greater expressive control over Voices and effects.



The Yamaha XF format enhances the SMF (Standard MIDI File) standard with greater functionality and open-ended expandability for the future. The Tyros5 is capable of displaying lyrics when an XF file containing lyric data is played.



“SFF (Style File Format)” is an original Style file format by Yamaha which uses a unique conversion system to provide high-quality automatic accompaniment based on a wide range of chord types. “SFF GE (Guitar Edition)” is an enhanced format of SFF, which features improved note transposition for guitar tracks.



“AEM” is the trademark of Yamaha's leading-edge tone generation technology. For information on AEM, refer to the Reference Manual on the website.

# Panel Controls and Terminals

## ■ Top Panel

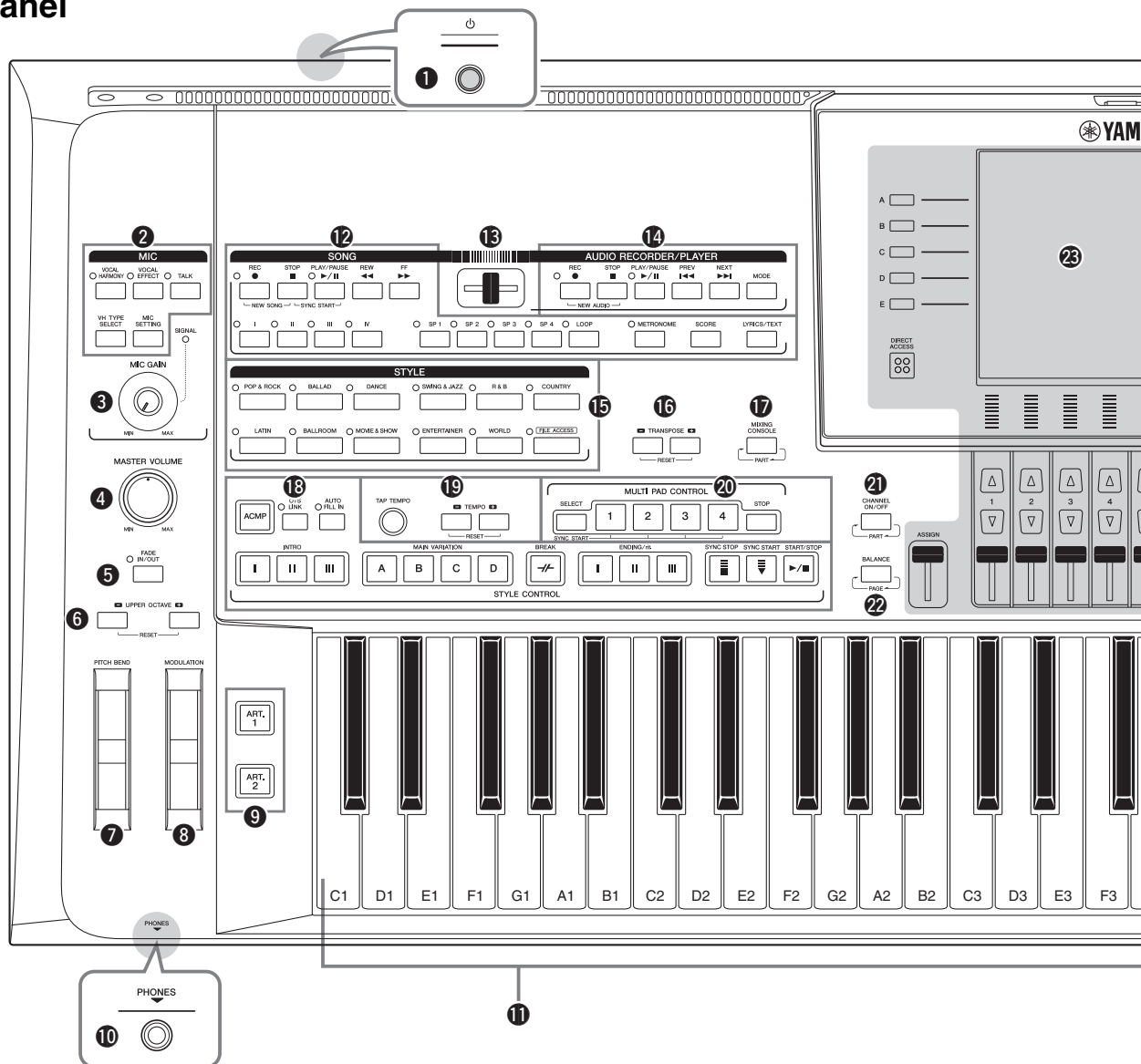

- 1 Power on/off switch** [⏻]..... **Page 16**  
Turn the instrument's power on (⏻) or off (⏷).
- 2 MIC buttons**..... **Page 88**  
For adding various effects to and controlling the Microphone input.
- 3 [MIC GAIN] knob**..... **Page 88**  
Adjusts the input sensitivity from the MIC jack.
- 4 [MASTER VOLUME] dial**..... **Page 16**  
Adjusts the overall volume.
- 5 [FADE IN/OUT] button** ..... **Page 54**  
Controls fade in/out of the Style/MIDI Song playback.
- 6 UPPER OCTAVE buttons**..... **Page 46**  
Shifts the pitch of the keyboard in octave steps.
- 7 [PITCH BEND] wheel**..... **Page 47**  
Bends the pitch of the keyboard-played sound up or down.
- 8 [MODULATION] wheel** ..... **Page 47**  
Applies vibrato effects, etc.
- 9 [ART. 1]/[ART. 2] buttons**.....**Page 40**  
Controls Super Articulation Voices.
- 10 [PHONES] jack** .....**Page 15**  
For connecting a pair of headphones.
- 11 Keyboard**  
The Tyros5 has two different models: a 76-key keyboard and a 61-key keyboard.
  - Tyros5-76: E0–G6
  - Tyros5-61: C1–C6
- 12 SONG buttons**.....**Page 68**  
For selecting MIDI Songs and controlling Song playback.
- 13 Cross Fader** .....**Page 79**  
Adjusts the volume balance between the MIDI song and audio playback.
- 14 AUDIO RECORDER/PLAYER buttons**.....**Page 76**  
Records your performance in audio format.
- 15 STYLE buttons**.....**Page 51**  
Selects a Style.



The illustration is of the Tyros5-61; however, the controls and terminals of the Tyros5-76 are the same.

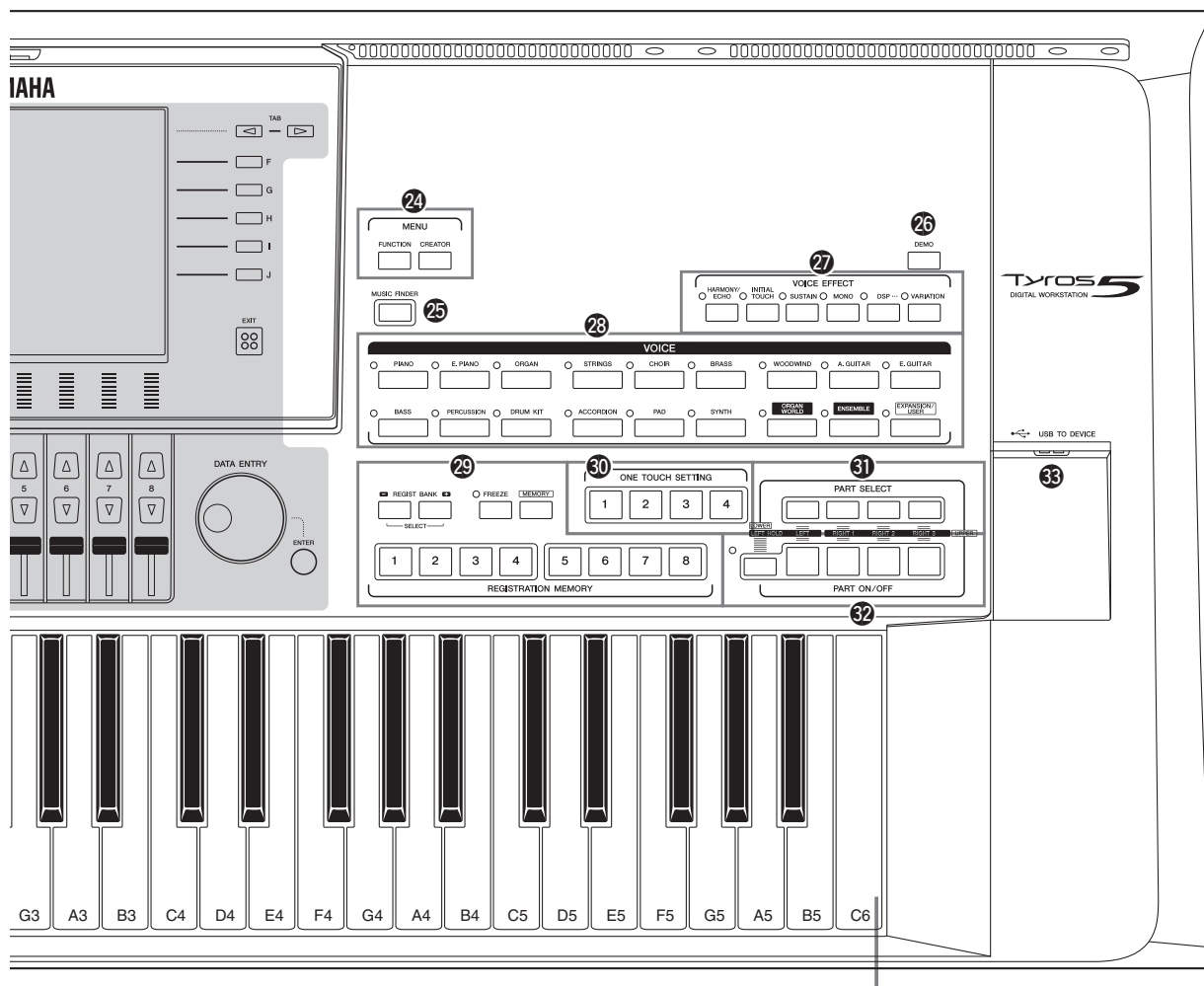

- 16 **TRANPOSE** buttons..... Page 46  
Transposes the pitch in semitone steps.
- 17 **[MIXING CONSOLE]** button ..... Page 92  
For controlling various aspects of the keyboard, Style and MIDI Song parts.
- 18 **STYLE CONTROL** buttons..... Page 53  
Controls Style playback.
- 19 **[TAP TEMPO]/TEMPO** buttons..... Page 54  
Controls the tempo for Style, MIDI Song and Metro-  
nome playback.
- 20 **MULTI PAD CONTROL** buttons..... Page 64  
Selects and plays a rhythmic or melodic Multi Pad  
phrase.
- 21 **[CHANNEL ON/OFF]** button..... Pages 60, 75  
Turns channels of the Style or MIDI Song on/off.
- 22 **[BALANCE]** button ..... Pages 61, 79  
Adjusts the volume balance among each part.

- 23 **LCD and related controls**..... Page 20

**NOTE**

Remove the transparent protective film that was applied to the display prior to shipment from the factory.

- 24 **MENU** buttons (refer to Reference Manual on the website)  
For accessing various advanced settings and creating your original Styles, MIDI Songs and Multi Pads.
- 25 **[MUSIC FINDER]** button..... Page 81  
Calls up panel settings (Record) ideal for your performance.
- 26 **[DEMO]** button ..... Page 17  
Plays the Demo.
- 27 **VOICE EFFECT** buttons..... Page 48  
For adding various effects to the keyboard performance.
- 28 **VOICE** buttons..... Page 36  
Selects a Voice.

- 29 REGISTRATION MEMORY buttons**..... Page 85  
Registers and recalls panel setups.
- 30 ONE TOUCH SETTING buttons**..... Page 56  
Calls up the appropriate panel settings for the Style.
- 31 PART SELECT buttons**..... Page 36  
Selects the keyboard parts to be played.

- 32 PART ON/OFF buttons**..... Page 38  
Turns the keyboard parts on or off.
- 33 [USB TO DEVICE] terminal**..... Page 101  
For connecting a USB flash memory.

## ■ Rear Panel

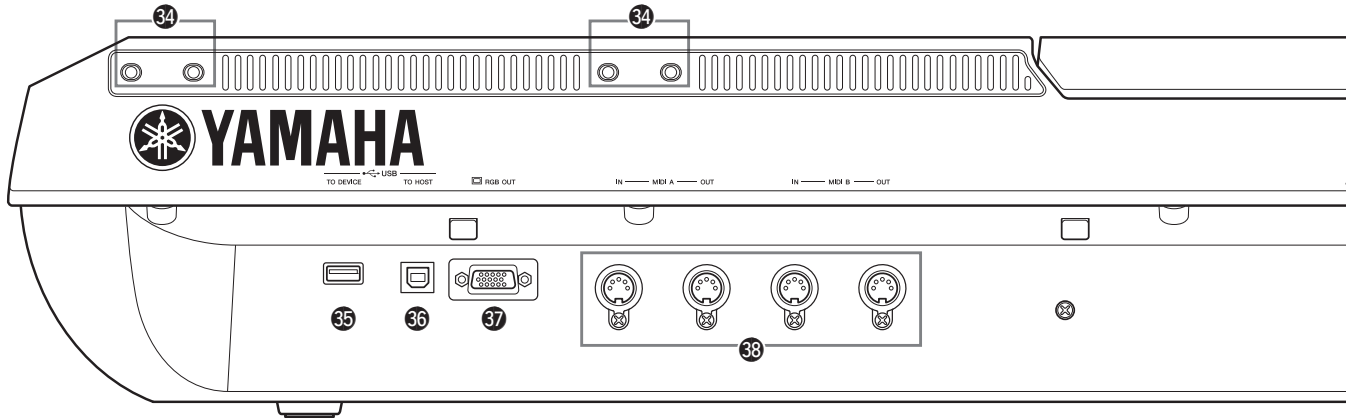

- 34 Slots** ..... Pages 14, 106  
The four slots nearest the display panel are for connecting the music rest brackets; the other slots are for connecting the speaker brackets of the optional TRS-MS05 speakers.
- 35 [USB TO DEVICE] terminal** ..... Page 101  
For connecting a USB flash memory or USB wireless LAN adaptor.
- 36 [USB TO HOST] terminal**..... Page 103  
For connecting to computer.

- 37 [RGB OUT] terminal**..... Page 99  
For connecting an external monitor.
- 38 MIDI terminals** ..... Page 105  
For connecting external MIDI devices.
- 39 ASSIGNABLE FOOT PEDAL jacks** ..... Page 100  
For connecting foot pedals.

## Attaching the Music Rest

- 1** Attach the two music rest brackets to the inside slots on the rear panel.
- 2** Attach the music rest to the brackets.

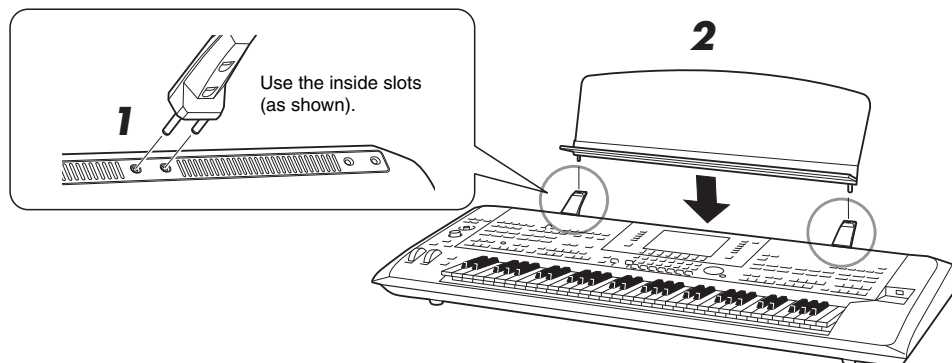

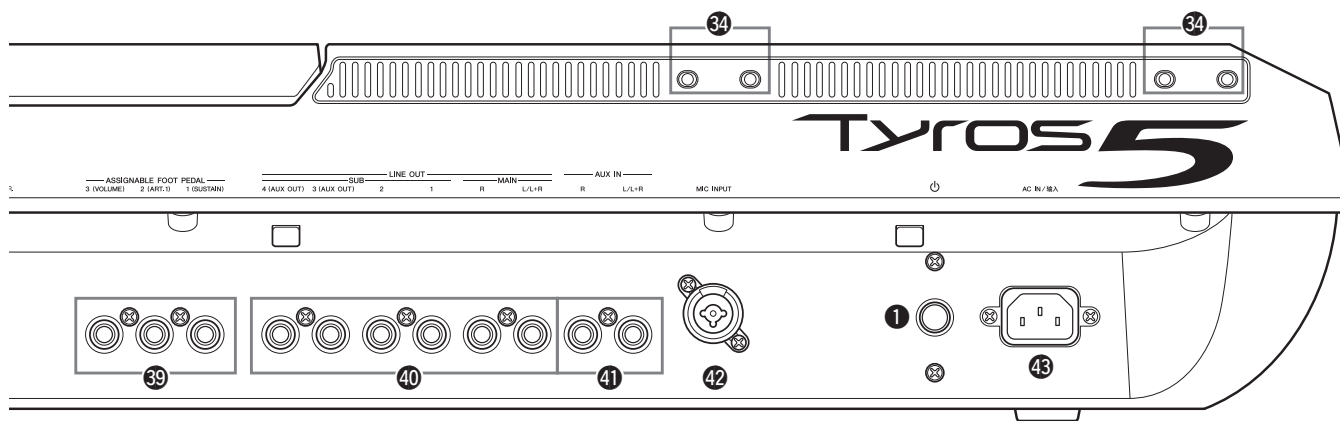

**40 LINE OUT jacks ..... Page 98**

For connecting audio devices such as a stereo system.

**41 AUX IN jacks..... Page 99**

For connecting audio devices such as a portable audio player.

**42 MIC INPUT jack ..... Page 88**

Combo jack\* for connecting microphone.

(\*: Combo jack accepts either XLR or 1/4" phone plug connectors.)

**43 AC IN jack..... Page 16**

For connecting the supplied power cord.

## Connecting headphones or speaker system

Since the instrument has no built-in speakers, you'll need to use external equipment, such as headphones or a speaker system, to hear the sound of the instrument.

● **Using headphones**

Connect a set of headphones to the [PHONE] jack

● **Using speaker system**

For instructions on installing the optional speakers TRS-MS05, refer to page 106. For instructions on connecting other speakers, refer to page 98.

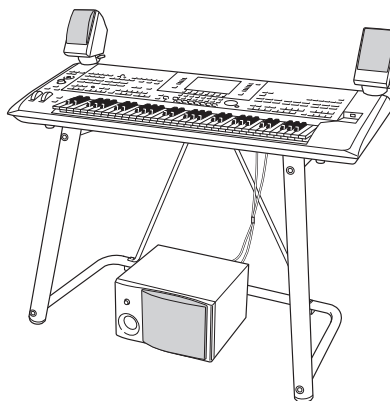
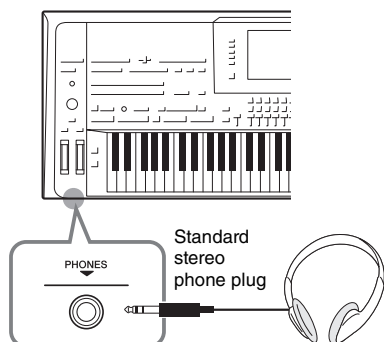

Shown here is the optional L-7S Keyboard Stand.

**CAUTION**

Do not listen with the headphones at high volume for long periods of time. Doing so may cause hearing loss.

# Starting Up

## Power Supply

- 1 Connect the supplied power cord to the [AC IN] jack on the instrument's rear panel.

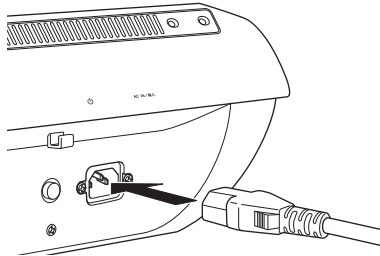

- 2 Connect the other end of the power cord to an AC outlet.

### NOTE

Before connecting the supplied power cord to the [AC IN] jack, be sure to read the "Power supply/Power cord" sections on PRECAUTIONS (page 6).

### WARNING

The type of AC power cord provided with the Tyros5 may be different depending on the country in which it is purchased (a third prong may be provided for grounding purposes). Improper connection of the grounding conductor can create the risk of electrical shock. Do NOT modify the plug provided with the Tyros5. If the plug will not fit the outlet, have a proper outlet installed by a qualified electrician. Do not use a plug adapter which defeats the grounding conductor.

## Turning the Power On/Off

- 1 Press the power on/off switch on the rear panel to turn the power on.

The MAIN display (page 24) appears.

- 2 Play the keyboard.

While playing the keyboard, adjust the volume level by using the [MASTER VOLUME] dial.

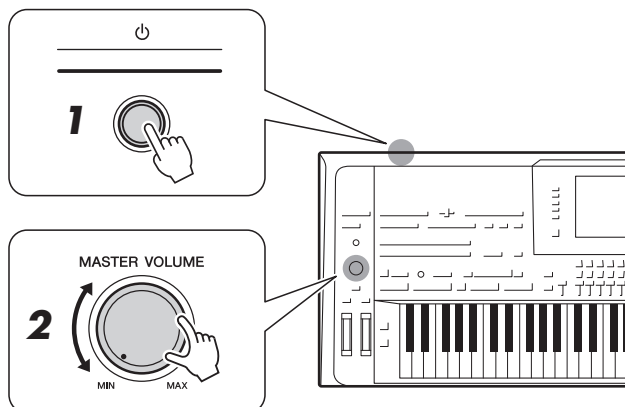

- 3 After you use the instrument, press the power on/off switch to turn the power off.

### NOTE

Before the MAIN display appears, the instrument will not sound nor can any operations be executed.

### NOTE

You need to use headphones or speaker system to hear the sound of the instrument (page 15).

### CAUTION

Even when the power is turned off, electricity is still flowing to the instrument at the minimum level. When you are not using the instrument for a long time, make sure you unplug the power cord from the AC outlet.

## Setting the Auto Power Off function

To prevent unnecessary power consumption, this instrument features an Auto Power Off function that automatically turns the power off if the instrument is not operated for a specified period of time. The amount of time that elapses before the power is automatically turned off is approximately 30 minutes by default; however, you can change the setting.

### 1 Call up the operation display.

[FUNCTION] → [H] (UTILITY) → TAB [◀][▶] CONFIG 1

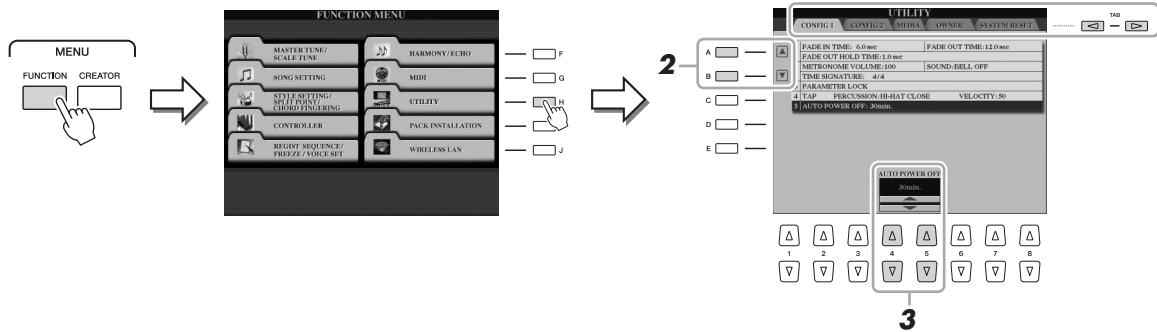

### 2 Use the [A] (▲)/[B] (▼) buttons to select “AUTO POWER OFF.”

### 3 Press the [4 ▲▼]/[5 ▲▼] buttons to set the value.

To disable Auto Power Off, select “DISABLED.”

#### NOTICE

Any data which is not saved via the Save operation (page 29) will be lost if the power automatically turns off. Make sure to save your data before the power turns off.

#### Disabling Auto Power Off (simple method)

Turn the power on while holding down the lowest key on the keyboard. An “Auto power off disabled” message appears briefly and Auto Power Off is disabled.

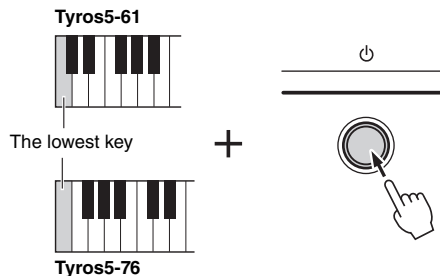

#### NOTICE

Depending on the instrument status, the power may not turn off automatically, even after the elapse of the specified period of time. Turn the power off manually as often as possible, when the instrument is not in use.

#### NOTE

To turn the power on after the Auto Power Off is executed, press the power switch to the OFF position (■), then press the Power Switch again to the ON position (■).

## Playing the Demo

You can play a Demo recording, complete with slideshow, that showcases the realistic Voices and dynamic Styles of the instrument.

### 1 Press the [DEMO] button to start the Demo.

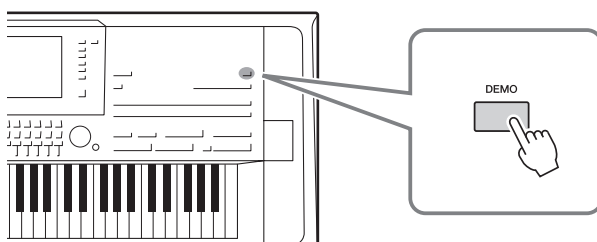

#### NOTE

You can pause and restart the Demo by pressing the SONG [PLAY/PAUSE] button.

### 2 Press the [EXIT] button to stop the Demo.

## Raising the Display Panel

- 1 Unfasten the lock located at the back of the panel.

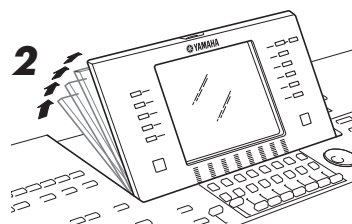
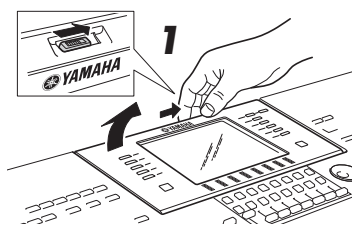

- 2 Lift the panel and tilt it toward you.

The panel will click at four latched positions. Once you've set it to a satisfactory position, release the panel. It will gently fall back to the nearest latched position.

To return the panel to its closed and locked position, gently pull it back toward you until the position is vertical, then push it down until it locks into place.

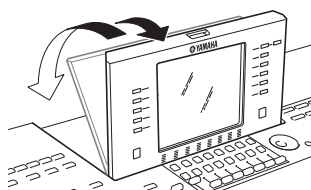

### **CAUTION**

Looking at the display for a long period of time in the dark may cause eyestrain or damage to your eyesight. Make sure to use the instrument with as much ambient light as possible and also take adequate breaks and rest from use.

## Changing the Display Language

This determines the language (English, German, French, Spanish and Italian are available) used in the display for messages and information.

- 1 Call up the OWNER display.  
[FUNCTION] → [H] UTILITY → TAB [◀][▶] OWNER

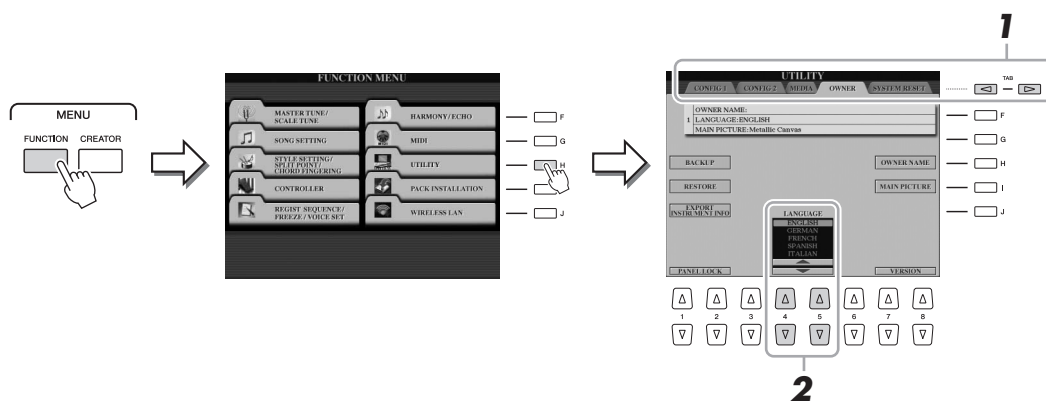

- 2 Use the [4 ▲▼]/[5 ▲▼] buttons to select the desired language.

## Displaying the Program Version

You can check the program version of this instrument.

- 1 Call up the OWNER display.**  
[FUNCTION] → [H] UTILITY → TAB [◀][▶] OWNER
- 2 Use the [7 ▲▼]/[8 ▲▼] (VERSION) buttons.**  
The program version and the hardware ID are shown in the display.
- 3 Press the [8 ▲▼] (EXIT) button to return to the previous display.**

## Locking the Panel Settings (Panel Lock)

When the panel settings are locked, nothing happens if you press any panel buttons. For example, when you take a break during your performance and leave the instrument unattended, this feature protects the panel settings from being accessed by others.

- 1 Call up the OWNER display.**  
[FUNCTION] → [H] UTILITY → TAB [◀][▶] OWNER

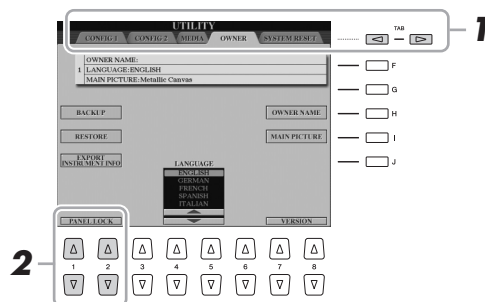

- 2 Press the [1 ▲▼]/[2 ▲▼] (PANEL LOCK) buttons.**  
The Pin Code display is called up.



- 3 Input a four-number PIN code by using the [2 ▲▼]–[7 ▲▼] buttons, then press the [8 ▲] (OK) button to enter it.**
- 4 To unlock the instrument, press the [1 ▲▼]/[2 ▲▼] (UNLOCK) buttons, then input the same PIN code you entered in step 3.**

### NOTE

If you have forgotten the PIN code, simply turn the power off and back on again to unlock the instrument.

# Basic Operations

## Display-based Controls

The LCD provides comprehensive at-a-glance information on all current settings. The displayed menu can be selected or changed by the controls surrounding the LCD.

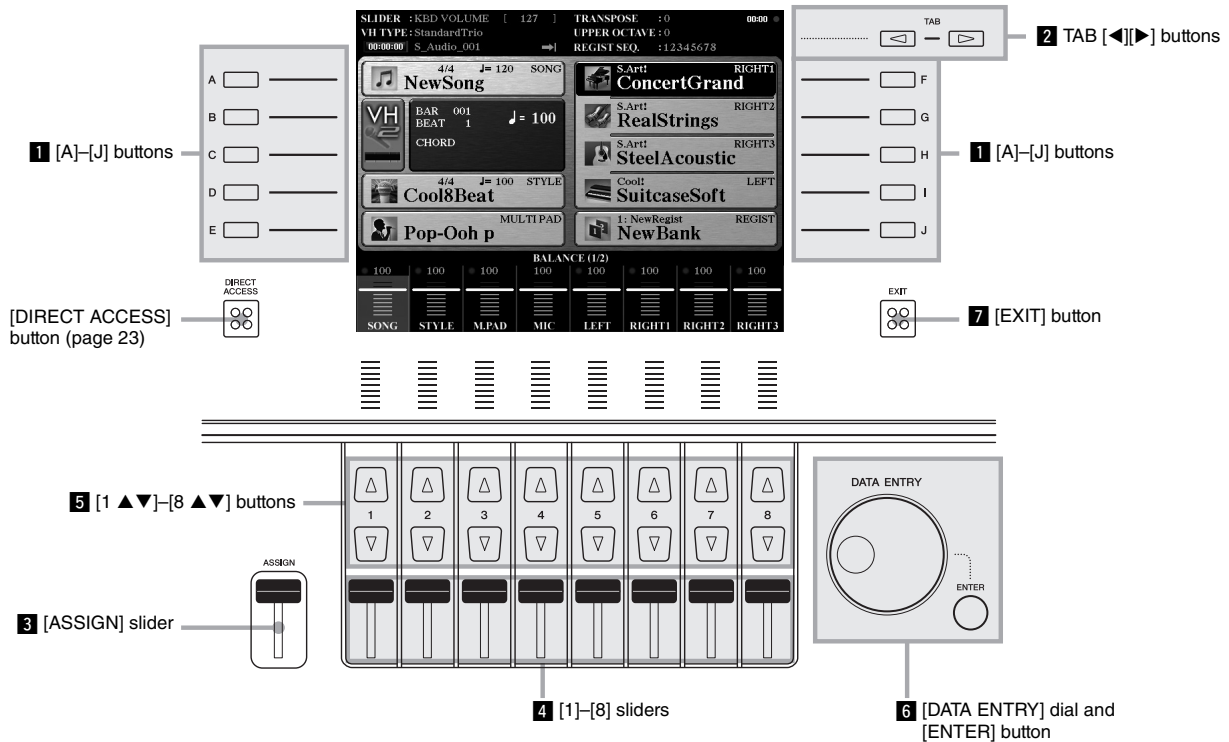

## 1 [A]-[J] buttons

The [A]-[J] buttons are used to select the corresponding menu items shown next to them.

### ● Example 1

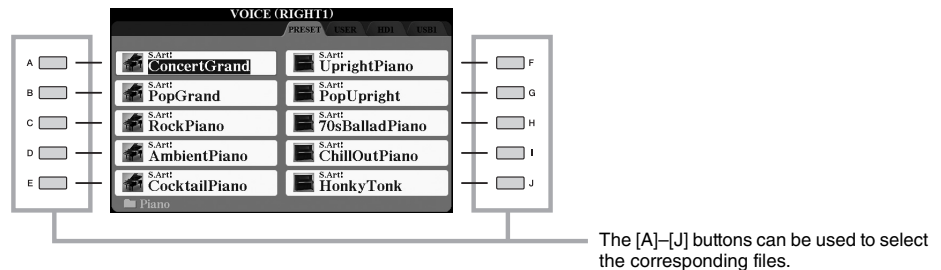

### ● Example 2

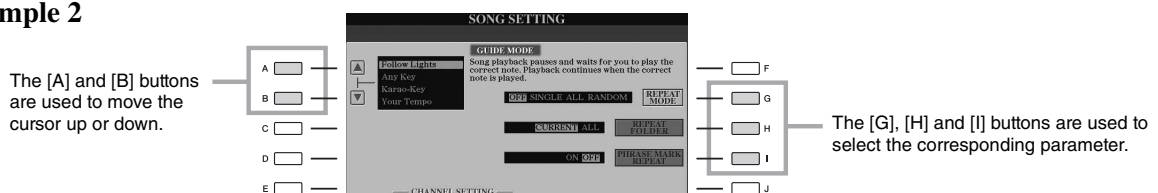



## 2 TAB [◀][▶] buttons

These buttons are used mainly to change the pages of displays that have “tabs” at the top.

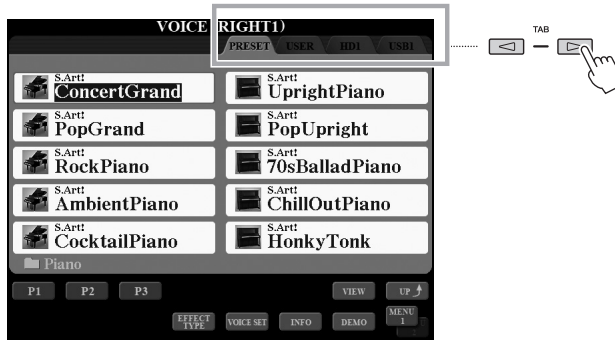

## 3 [ASSIGN] slider

The [ASSIGN] slider is used to adjust the setting of a user-assigned function. By default, this slider is used to adjust the keyboard volume directly during your performance.

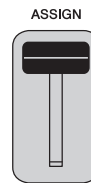

### NOTE

You can freely change the function assigned to the [ASSIGN] slider:  
[FUNCTION] → [D] CONTROLLER → TAB [◀][▶] ASSIGN SLIDER.

## 4 [1]–[8] sliders

These sliders are used to adjust settings (up or down correspondingly) for functions shown directly above them, only when the menu is shown in a knob or slider shape.

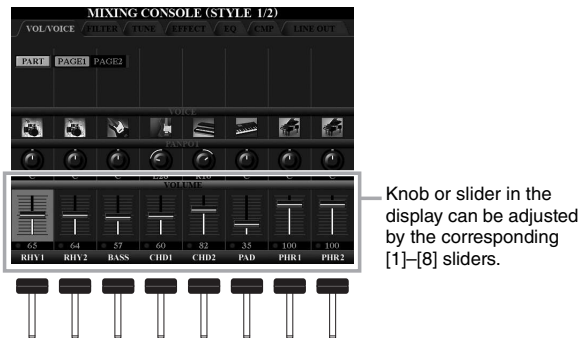

## 5 [1 ▲▼]–[8 ▲▼] buttons

The [1 ▲▼]–[8 ▲▼] buttons are used to make selections or adjust settings (up or down correspondingly) for functions shown directly above them.

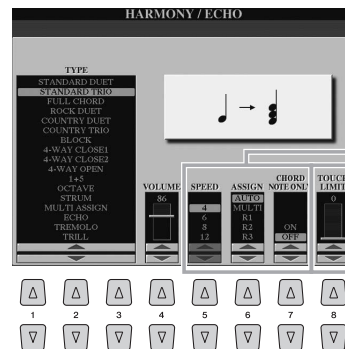

## 6 [DATA ENTRY] dial and [ENTER] button

Depending on the selected display, the [DATA ENTRY] dial can be used in the following two ways.

### ● Selecting files (Voice, Style, Song, and so on)

You can use the [DATA ENTRY] dial and the [ENTER] button to select a file.

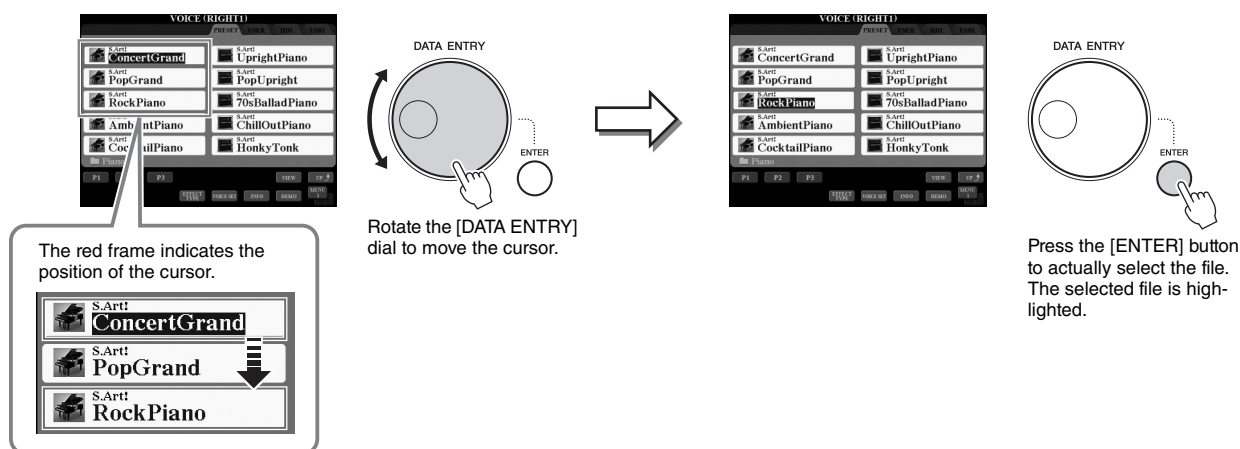

### ● Adjusting the parameter values

In addition to using sliders, you can conveniently use the [DATA ENTRY] dial in tandem with the [1 ▲▼]–[8 ▲▼] buttons to adjust parameters indicated in the display.

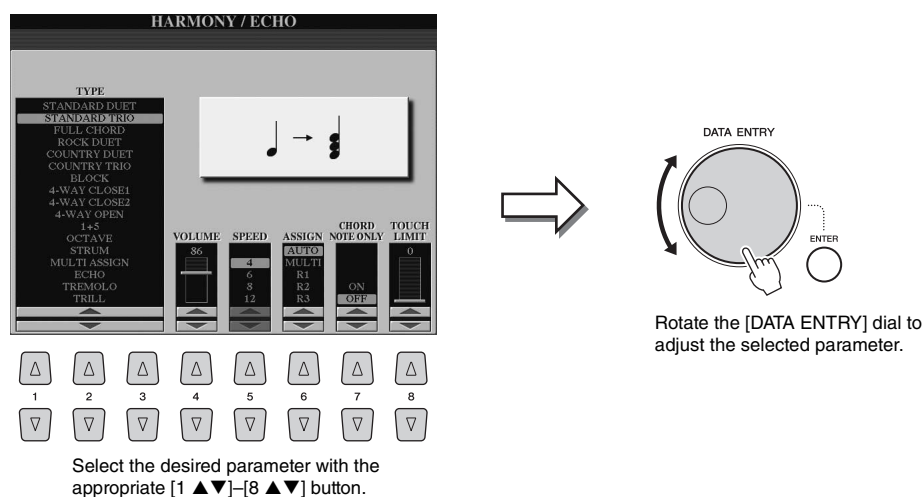

This convenient technique also works well with pop-up parameters such as Tempo and Transpose. Simply press the appropriate button (ex., TEMPO [+]), then rotate the [DATA ENTRY] dial and press [ENTER] to close the window.

## 7 [EXIT] button

Pressing the [EXIT] button returns you to the previously indicated display.

Pressing the [EXIT] button several times returns to the default Main display (page 24).



## Calling Up the Desired Display Instantly—Direct Access

With the convenient Direct Access function, you can instantly call up the desired display—with just a single additional button press.

### 1 Press the [DIRECT ACCESS] button.

A message appears in the display prompting you to press the appropriate button.

### 2 Press the button (or move the slider, wheel or connected pedal) corresponding to the desired setting display to instantly call up that display.

Refer to the “Direct Access Chart” on page 110 for a list of the displays that can be called up with the [DIRECT ACCESS] button.

For example, pressing the [DEMO] button here calls up the OWNER display in which the display language can be chosen.

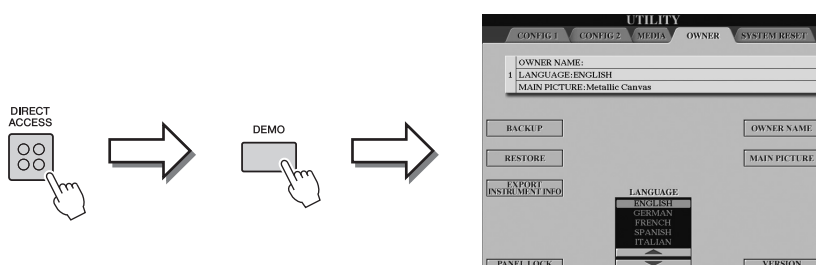

## Messages Shown in the Display

A message (information or confirmation dialog) sometimes appears on the screen to facilitate operation. When the message appears, simply press the appropriate button.



## Main Display Configuration

The display that appears when the power is turned on is the Main display. This display shows the current basic settings such as the currently selected Voice and Style, allowing you to see them at a single glance. The Main display is the one you'll usually see when you play the keyboard.

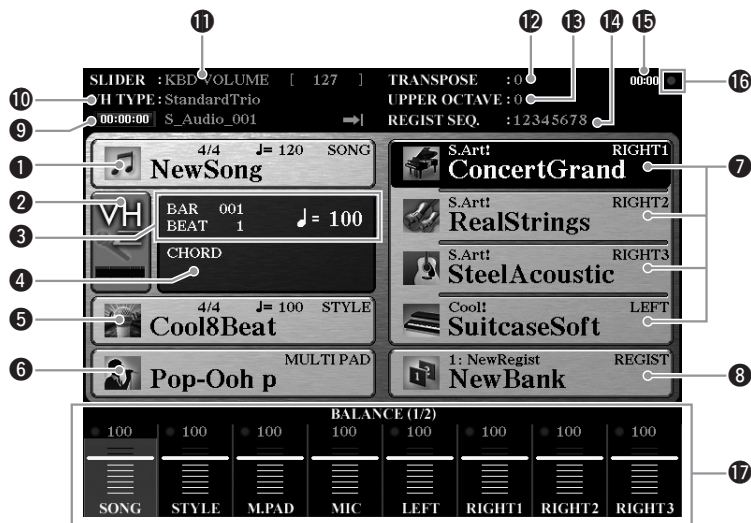

### 1 Song name and related information

Displays the currently selected Song name, time signature and tempo. Pressing the [A] button calls up the Song Selection display (page 71).

### 2 MIC Input level indicator

When a microphone is connected (page 88), this indicates the input level. Adjust the level with the [MIC GAIN] knob so that the indicator shows in green or yellow (but not in red). Pressing the [B]/[C] buttons calls up the Vocal Harmony Type Selection display (page 89).

### 3 BAR/BEAT/TEMPO

Displays the current position (bar/beat/tempo) in Style playback or Song playback.

### 4 Current chord name

When the [ACMP] button is set to on, the chord specified in the chord section of the keyboard will be displayed. When the Song containing the chord data is played, the current chord name will be displayed.

### 5 Style name and related information

Displays the currently selected Style name, time signature and tempo. Pressing the [D] button calls up the Style Selection display (page 51).

### 6 Multi Pad Bank name

Displays the names of the selected Multi Pad Banks. Pressing the [E] button calls up the Multi Pad Bank Selection display (page 64).

### 7 Voice name

Displays the Voice names currently selected for RIGHT 1, RIGHT 2, RIGHT 3 and LEFT parts. Use the [F], [G], [H] and [I] buttons to call up the Voice Selection display for the corresponding part (page 36): Press the button once to highlight the part's Voice, then once more to call up the Voice Selection display.

### 8 Registration Memory Bank name

Displays the currently selected Registration Memory Bank name and Registration Memory number. Pressing the [J] button calls up the Registration Memory Bank Selection display (page 86).

### 9 Audio Song information

Displays information for the selected audio file (mode, file name and time).

**10 Vocal Harmony Type**

Displays the currently selected Vocal Harmony Type (page 89).

**11 ASSIGN slider function**

Displays the function (parameter) assigned to the ASSIGN slider and its value (page 21).

**12 Transpose**

Displays the amount of transposition in semitone units (page 46).

**13 Upper Octave**

Displays the amount that the octave value is shifted (page 46).

**14 Registration Sequence**

Appears when the Registration Sequence is active. For instructions on programming the sequence, refer to the Reference Manual on the website.

**15 Clock**

Once this instrument has accessed the network via the USB Wireless LAN Adaptor, the current time is shown here.

**16 READ/WRITE lamp**

Flashes briefly while this instrument is accessing the internal hard disk or the USB flash memory connected to the [USB TO DEVICE] terminal.

**17 Volume Balance or Channel On/Off settings**

Displays the volume balance or channel on/off settings among the parts. Use the [1 ▲▼]–[8 ▲▼] buttons or sliders to change the settings.

**NOTE**

Press the [BALANCE] button to call up the volume BALANCE displays, and press the [CHANNEL ON/OFF] button to call up the CHANNEL ON/OFF displays.

## File Selection Display Configuration

The File Selection display is for selecting Voices, Styles, and other data. The File Selection display appears when you press one of the VOICE or STYLE buttons, MULTI PAD CONTROL [SELECT] button, etc.

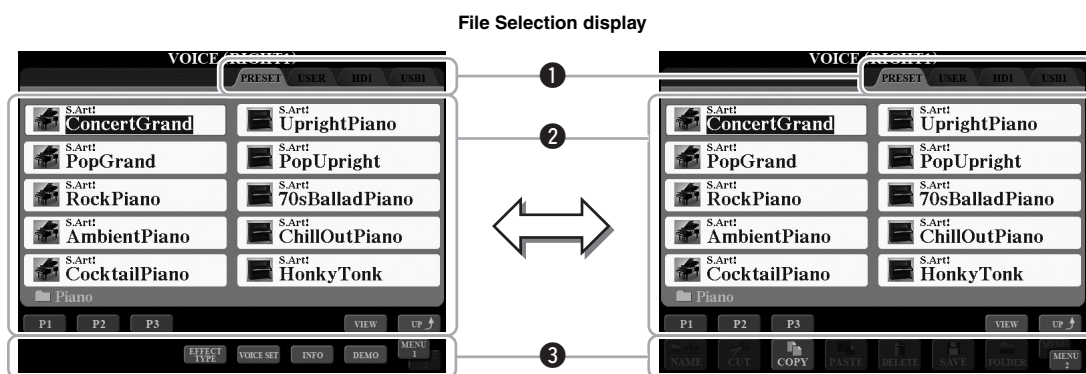

**1 Location (drive) of data**

- **PRESET** .....Location where pre-programmed (preset) data is stored.
- **USER** .....Location where recorded or edited data is saved.
- **HD**.....Location where data is saved to an internal hard disk drive.
- **USB** .....Location where data on USB storage device (flash memory, etc.) is saved. This appears only when USB storage device(s) is connected to the [USB TO DEVICE] terminal (page 101).

**2 Selectable data (files)**

The files that can be selected on this display are shown. If more than 10 files exist, page numbers (P1, P2 ...) are shown below the files. Pressing the corresponding button ([1 ▲], [2 ▲], etc.) changes the display page. When other pages follow, the “Next” button appears, and for the previous page, the “Prev.” button appears.

**NOTE**

The data, both pre-programmed and your own original, are saved as “files.”

### 3 MENU 1/MENU 2

At the bottom of the File Selection display, you can toggle the indication between MENU 1 and MENU 2 by pressing the [8 ▼] button. Selecting MENU 1 shows the function names related to the current file (Voice, Style, Song, etc.) while selecting MENU 2 shows the function names of the file/folder management (page 29). When MENU 1 is selected with the Voice selection display, for example, pressing the [7 ▼] button will play back the Voice demo. When MENU 2 is selected, you can use the file/folder management functions such as save, copy, move and delete.

#### Calling up the next highest level folder

When the files of a folder are displayed, “UP” is appeared above the [8 ▲] button. Pressing this button calls up the next highest level folder.

#### Example of the PRESET Voice Selection display

The PRESET Voices are categorized and contained in appropriate folders.

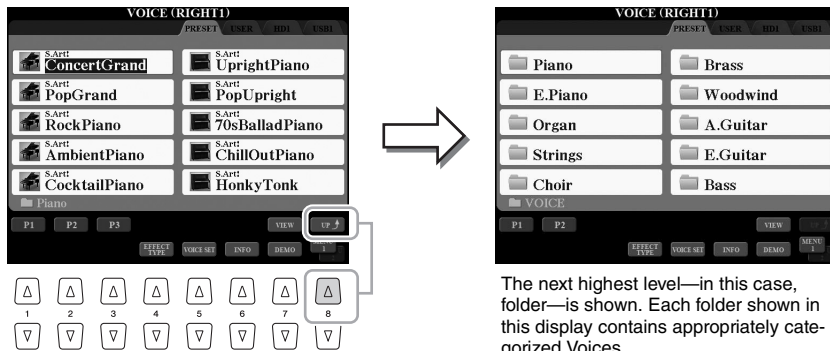

This display shows the Voices in a folder.

The next highest level—in this case, folder—is shown. Each folder shown in this display contains appropriately categorized Voices.

# Changing the File Selection Display View

The File Selection display actually has two different view types. One is Normal View, which we've seen up until this point. The other is List View, which lets you open files according to their numbers. Since the Tyros5 has many files spread out over several pages, number input in List View may be quicker and more convenient—providing you know the number of the file.

Switch between the two types by pressing the [7 ▲] (VIEW) button.

File Selection display—Normal View (page 25)

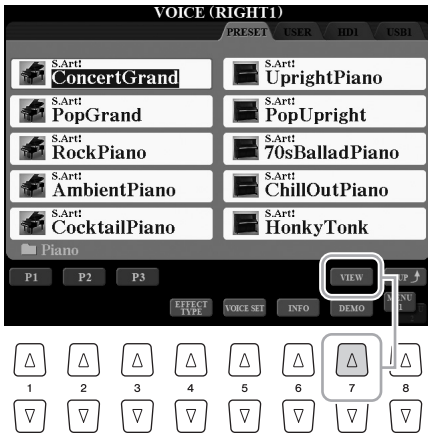

File Selection display—List View (see below)



Basic Operations

[F]	PROPERTY	Shows the property (location, name and size) of the file.
[G]	(TOP)	Moves the cursor (red frame) to the top of this list.
[H]/[I]	PAGE UP/DOWN	Scrolls by pages up/down through the list.
[J]	(END)	Moves the cursor to the end of this list.
[1 ▲▼]– [5 ▲▼]	(Number Input)	Input the desired number. To select Voice number 012, for example, press the buttons corresponding to “1” and “2” in sequence, and press the [ENTER] button. Entering one-digit numbers is done in the same way.
[6 ▲▼]	(UP/DOWN)	Selects the next or previous file.
[7 ▼]	CLEAR	Press this to cancel the number you’ve input.

## Memorizing Song/Style paths

The File Selection display for Songs and Styles lets you memorize the path of specific Song/Style to one of the panel buttons. Even if your data is scattered across the drive in a complex hierarchy of folders and paths, you can instantly call up a specific file—no matter how deeply hidden—with a single button-press.

- 1 In the List View display, select the Song/Style to be memorized, then press the [E] (MEMORY) button.



- 2 For Songs, press one of the SONG [I]–[IV] buttons; for Styles, press one of the STYLE category selection buttons (other than the [FILE ACCESS] button).  
The path is memorized to the selected button.
- 3 Exit from the Song/Style Selection display by pressing the [EXIT] button, then call up the memorized path.

To call up the memorized path for a Song, simply press the appropriate SONG button selected in step 2.

To call up the memorized path for a Style, first turn on the [FILE ACCESS] button, then press the appropriate STYLE button selected in step 2.

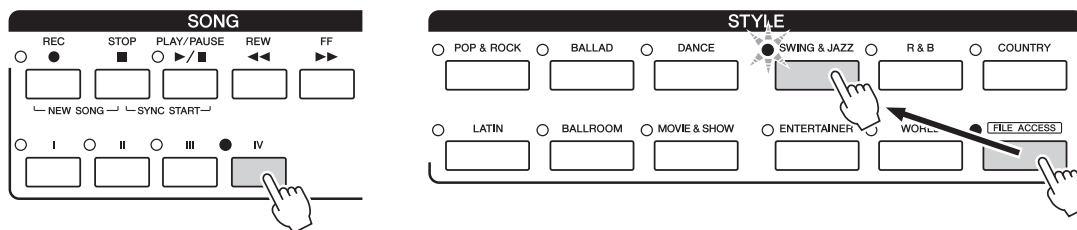



# File Management

You can save, name, copy/move, delete files, and you can create folders to manage the files with the buttons located lower area in the File Selection display. For information on the File Selection display, refer to page 25.

## Restrictions for protected Songs

Preset Songs and most commercially available songs are copy protected to prevent illegal copying or accidental erasure. They are marked by the indications at the upper left side of the file names. The indications and relevant restrictions are detailed below.



- **Prot. 1:** Indicates Preset Songs copied to the USER drive. These only can be copied/moved/deleted in the USER drive.
- **Prot. 2 Orig:** Indicates Yamaha-protection-formatted Songs. These cannot be copied. These can be moved/saved only to the USER drive and USB flash memories with ID.

## Saving a File

You can save your original data (such as Songs you've recorded) as a file to USER, HD or USB drive (page 25).

- 1** In the relevant File Selection display, select the appropriate tab (USER, HD or USB) to which you want to save the data by using the TAB [◀][▶] buttons.

If you want to save the data within an existing folder, also select the folder here.

### NOTE

Before using a USB flash memory, be sure to read "Connecting USB Devices" on page 101.



- 2** Make sure that MENU 2 is shown at the bottom right corner of the display.

If necessary, press the [8 ▼] button to call up MENU 2.

- 3** Press the [6 ▼] (SAVE) button.

The Character Entry window (page 34) is called up.



### NOTE

In the USER tab, the maximum total number of files which can be stored differs depending on the file size and the length of the file names.

#### 4 Enter the file name.

Even if you skip this step, you can rename (page 31) the file at any time after saving.

#### 5 Press the [8 ▲] (OK) button to actually save the file.

The saved file will be automatically located at the appropriate position among the files in alphabetical order.

#### NOTE

If you want to cancel the Save operation, press the [8 ▼] (CANCEL) button before step 5 below.

## Creating a New Folder

You can create folders.

#### 1 In the file selection display, select the appropriate tab (USER, HD or USB) to which you want to create a new folder by using the TAB [◀][▶] buttons.

If you want to create a new folder within an existing folder, also select the folder here.

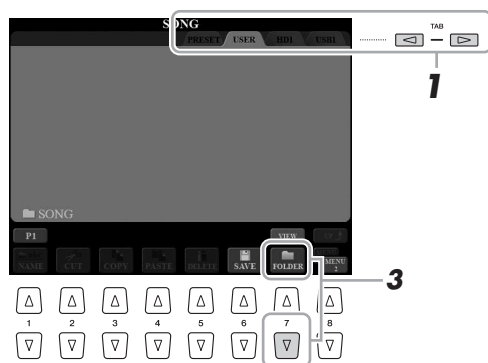

#### NOTE

A new folder cannot be made in the PRESET tab.

#### NOTE

The maximum number of files/folders which can be stored in a folder is 500.

#### NOTE

In the USER tab, folder directories can contain up to four levels. The maximum total number of files/folders which can be stored differs depending on the file size and the length of the file/folder names.

#### 2 Make sure that MENU 2 is shown at the bottom right corner of the display.

If necessary, press the [8 ▼] button to call up MENU 2.

#### 3 Press the [7 ▼] (FOLDER) button.

The Character Entry window (page 34) is called up.



#### NOTE

To cancel the operation, press the [8 ▼] (CANCEL) button.

#### **NOTICE**

**Do not use "Expansion" for the folder name. Otherwise, all data contained in the "Expansion" folder will be lost when an Expansion Pack is installed.**

#### 4 Enter the name of the new folder.

For detailed instructions on naming, see page 34.

# Renaming a File/Folder

You can rename files/folders.

 **NOTE**

Files in the PRESET tab cannot be renamed.

- 1 Call up the display containing the file/folder you want to rename.**
- 2 Make sure that MENU 2 is shown at the bottom right corner of the display.**  
If necessary, press the [8 ▼] button to call up MENU 2.
- 3 Press the [1 ▼] (NAME) button.**  
The pop-up window for the Rename operation appears at the bottom of the display.

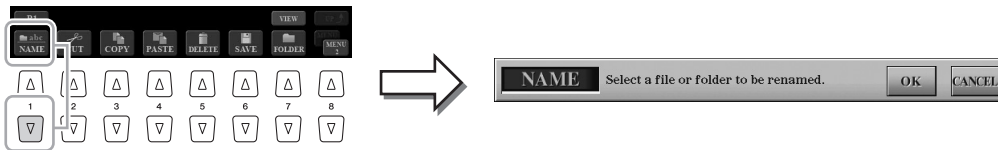

- 4 Press one of the [A]–[J] buttons corresponding to the desired file/folder.**
- 5 Press the [7 ▼] (OK) button to confirm the file/folder selection.**  
The Character Entry window (page 34) is called up.
- 6 Enter the name of the selected file/folder.**  
For detailed instructions on naming, see page 34.

 **NOTE**

To cancel the Rename operation, press the [8 ▼] (CANCEL) button.

**NOTICE**

**Do not use “Expansion” for the folder name. Otherwise, all data contained in the “Expansion” folder will be lost when an Expansion Pack is installed.**

## Copying or Moving Files

You can copy or cut files and paste them to another location (folder). You can also copy folders (but not move them) by using the same procedure.

**1 Call up the display containing the files/folders you want to copy or move.**

**2 Make sure that MENU 2 is shown at the bottom right corner of the display.**

As necessary, press the [8 ▼] button to call up MENU 2.

**3 Press the [3 ▼] (COPY) button to copy or [2 ▼] (CUT) to move.**

The pop-up window for the Copy/Cut operation appears at the bottom of the display.

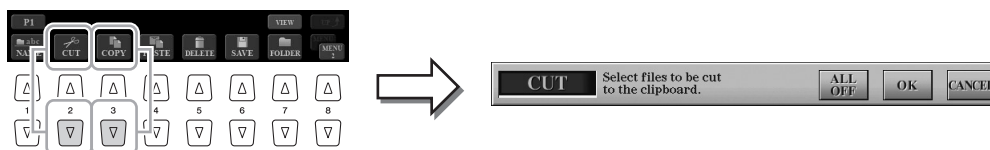

**4 Press the [A]–[J] buttons corresponding to the desired file/folder.**

Pressing a button selects (highlights) the file/folder. To cancel the selection, press the same [A]–[J] button again.

Press the [6 ▼] (ALL) button to select all files/folders indicated on the current display including the other pages. To cancel the selection, press the [6 ▼] (ALL OFF) button again.

**5 Press the [7 ▼] (OK) button to confirm the file/folder selection.**

**6 Select the destination tab (USER, HD or USB) to paste the file/folder, by using the TAB [◀][▶] buttons.**

If necessary, select the destination folder by using the [A]–[J] buttons.

**7 Press the [4 ▼] (PASTE) button to paste the file/folder selected in step 3.**

The pasted files/folders appear on the display at the appropriate position among the files in alphabetical order.

### NOTE

Copying of commercially available musical data including but not limited to MIDI data and/or audio data is strictly prohibited except for your personal use.

### NOTE

Files in the PRESET tab cannot be moved. They can only be copied.

### NOTE

To cancel the Copy operation, press the [8 ▼] (CANCEL) button.

# Deleting Files/Folders

You can delete files/folders.

**NOTE**  
Files in the PRESET tab cannot be deleted.

**1** Call up the display containing the file/folder you want to delete.

**2** Make sure that MENU 2 is shown at the bottom right corner of the display.

As necessary, press the [8 ▼] button to call up MENU 2.

**3** Press the [5 ▼] (DELETE) button.

The pop-up window for the Delete operation appears at the bottom of the display.

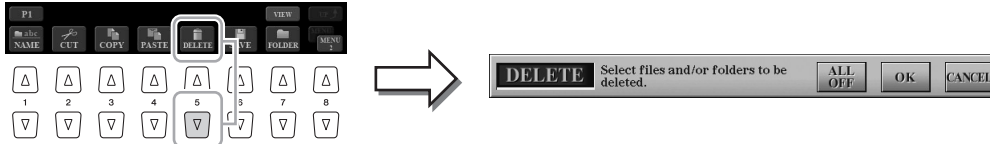

**4** Press the [A]–[J] buttons corresponding to the desired file/folder.

Pressing a button selects (highlights) the file/folder. To cancel the selection, press the same [A]–[J] button again.

Press the [6 ▼] (ALL) button to select all files/folders indicated on the current display including the other pages. To cancel the selection, press the [6 ▼] (ALL OFF) button again.

**NOTE**  
To cancel the Delete operation, press the [8 ▼] (CANCEL) button.

**5** Press the [7 ▼] (OK) button to confirm the file/folder selection.

**6** Follow the on-display instructions.

- YES .....Delete the file/folder
- YES ALL .....Delete all selected files/folders
- NO .....Leave the file/folder as is without deleting
- CANCEL .....Cancel the Delete operation

# Entering Characters

This section covers how to enter characters for naming your files/folders, inputting keywords on Music Finder (page 81), etc. Entering characters should be done in the display shown below.

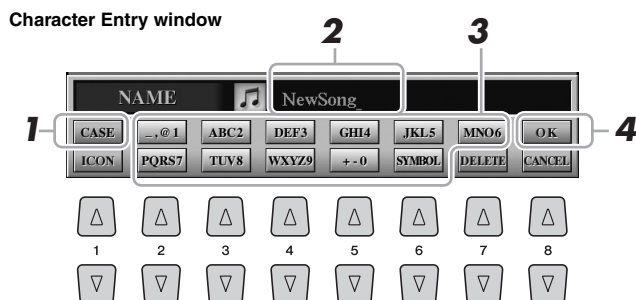

## 1 Change the type of character by pressing the [1 ▲] button.

- **CASE** .....capital letters, numbers, marks
- **case** .....lowercase letters, numbers, marks

## 2 Use the [DATA ENTRY] dial to move the cursor to the desired position.

## 3 Press the [2 ▲▼]–[6 ▲▼] and [7 ▲] buttons, corresponding to the character you wish to enter.

Several different characters are assigned to each button, and the characters change each time you press the button.

To actually enter the selected character, move the cursor or press another character-input button. Alternately, you can wait for a short time and the characters will be entered automatically.

For more information on entering characters, refer to “Other character-entry operations” below.

## 4 Press the [8 ▲] (OK) button to actually enter the name and complete the operation (such as Save and Rename).

### NOTE

The following marks cannot be entered for a file/folder name.  
\\ : \* ? " < > |

### NOTE

File names can contain up to 41 characters and folder names can contain up to 50 characters.

### NOTE

To cancel the character-entering operation, press the [8 ▼] (CANCEL) button.

## Other character-entry operations

### ● Deleting characters

Move the cursor to the character you wish to delete by using the [DATA ENTRY] dial, and press the [7 ▼] (DELETE) button. To delete all characters on the line at once, press and hold the [7 ▼] (DELETE) button.

### ● Entering symbols or space

- 1 Press the [6 ▼] (SYMBOL) button to call up the list.
- 2 Use the [DATA ENTRY] dial to move the cursor to the desired symbol or space, then press the [8 ▲] (OK) button.

### ● Selecting custom icons for files (shown at left of file name)

- 1 Press the [1 ▼] (ICON) button to call up the ICON SELECT display.
- 2 Select the icon by using the [A]–[J] buttons, [3 ▲▼]–[5 ▲▼] buttons or [DATA ENTRY] dial. The display includes several pages. Press the TAB [◀][▶] buttons to select different pages.
- 3 Press the [8 ▲] (OK) button to apply the selected icon.

### NOTE

To cancel the operation, press the [8 ▼] (CANCEL) button.

## Restoring the Factory-programmed Settings

While holding the right-most key on the keyboard, turn the power on. This restores all settings to the factory default.

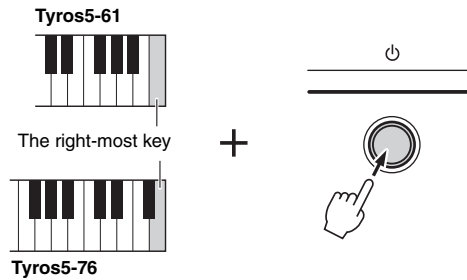

You can also restore the factory default value of specified settings or delete all files/folders in the USER drive. Call up the operation display: [FUNCTION] → [H] UTILITY → TAB [◀][▶] SYSTEM RESET. For details, refer to the Reference Manual on the website.

## Data Backup

You can back up all data saved in USER drive (except Protected Songs and Expansion Voices/Styles) and all settings to a USB flash memory as a single file. This procedure is recommended for data security and backup in case of damage.

**1** Connect the USB flash memory to the [USB TO DEVICE] terminal as backup destination.

**2** Call up the operation display.

[FUNCTION] → [H] UTILITY → TAB [◀][▶] OWNER

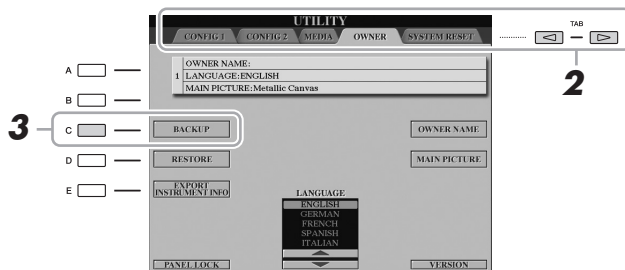

**3** Press the [C] (BACKUP) button to save the backup file to the USB storage device.

**4** Follow the on-display instructions.

**NOTE**

Before using a USB flash memory, be sure to read "Connecting USB Devices" on page 101.

**NOTICE**

**Move the Protected Songs (saved to the USER drive) to USB flash memory before restoring. If the songs are not moved, the operation deletes the data.**

**NOTE**

You can also back up files in the USER drive such as Voice, Song, Style, Multi Pad and Registration Memory by copying them individually to USB flash memory as desired. For instructions, refer to page 32.

**NOTE**

Completing the backup/restore operation may take a few minutes.

**NOTE**

You can also back up System settings, MIDI settings, User Effect settings, and Music Finder Records individually as desired. Call up the operation display: [FUNCTION] → [H] UTILITY → TAB [◀][▶] SYSTEM RESET. For more information, refer to the Reference Manual on the website.

## Restoring the Backup File

To do this, press the [D] (RESTORE) button in the OWNER page. When the operation is completed, the instrument will be restarted.

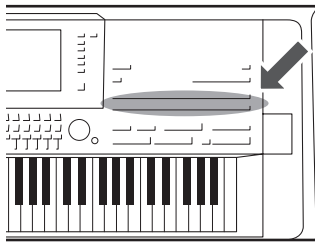

The Tyros5 features a wide variety of exceptionally realistic instrumental Voices, including piano, guitar, strings, brass, wind instruments and more.

## Playing Preset Voices

### Selecting a Voice (RIGHT 1) and playing the keyboard

#### 1 Press the PART SELECT [RIGHT 1] button.

Make sure that the PART ON/OFF [RIGHT1] button is also turned on. If it is turned off, the right-hand part will not sound.

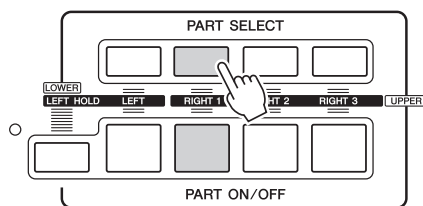

#### 2 Press one of the VOICE buttons to select a Voice category and call up the Voice Selection display.

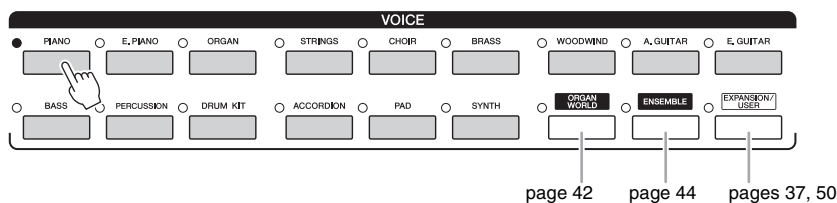

The preset Voices are categorized and contained in appropriate folders. Voice buttons on the panel correspond to the categories of the preset Voices. For example, press the [PIANO] button to display various piano Voices.



### 3 Press one of the [A]–[J] buttons to select the desired Voice.

You can call up the other pages by pressing the buttons that correspond to the page numbers (P1, P2 ...) or pressing the same VOICE button several times.



#### **NOTE**

The Voice type and its defining characteristics are indicated above the Preset Voice name. For details on the characteristics, see page 39.

#### **NOTE**

You can call up the information for the selected Voice by pressing the [6 ▼] (INFO) button (Some Voices do not have the information display.) To close the information display, press any panel button.

#### To listen to a short demo phrases for each Voice

Press the [7 ▼] (DEMO) button to start the demo for the selected Voice. To stop the demo, press the [7 ▼] button again.

#### **NOTE**

Make sure that MENU 1 is shown at the bottom right corner of the display (page 26).

### 4 Play the keyboard.

#### Calling up your favorite Voices quickly

By copying your favorite or often used Voices to the USER drive, you can call them up quickly.

- 1 Copy (page 32) your favorite Voice from the PRESET drive to the USER drive.
- 2 Press the [EXPANSION/USER] button, then press one of the [A]–[J] buttons to call up the Voice.

## Playing Two or Three Voices Simultaneously (Layer)

1 Make sure that PART ON/OFF [RIGHT 1] button is turned on.

2 Press the PART ON/OFF [RIGHT 2] button to turn it on.

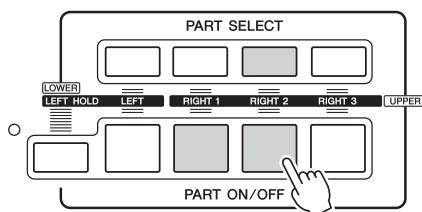

3 Press one of the VOICE buttons to call up the Voice Selection display for the Right 2 part.

4 Press one of the [A]–[J] buttons to select the desired Voice.

5 Play the keyboard.

The Voice selected for RIGHT 1 (page 36) and the Voice selected here are sounded simultaneously in a layer.

Voice RIGHT 3 can be set in the same way described above, by using the [RIGHT 3] button instead.

#### **NOTE**

You can save the settings to Registration Memory. See page 85.

## Playing Different Voices with the Left and Right Hands (Split)

- 1** Make sure that at least one of the PART ON/OFF [RIGHT 1]–[RIGHT 3] buttons are turned on.
- 2** Press the PART ON/OFF [LEFT] button to turn it on.

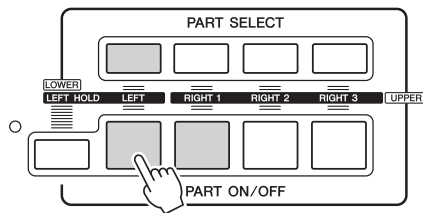

- 3** Press one of the VOICE buttons to call up the Voice Selection display for the Left part.
- 4** Press one of the [A]–[J] buttons to select the desired Voice.
- 5** Play the keyboard.

The notes you play with your left hand sound one Voice (LEFT Voice selected above), while the notes you play with your right sound different Voices (RIGHT 1–3 Voices).

### NOTE

You can save the settings to Registration Memory. See page 85.

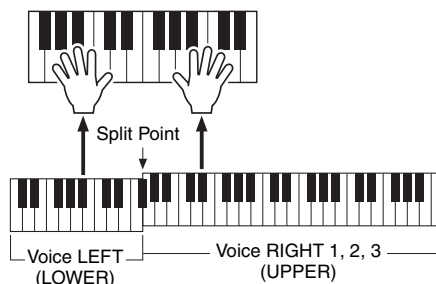

### Keyboard Parts

The Voices can be played via four keyboard parts: Left, Right 1, 2 and 3. These playing parts allow you to play just one single Voice, play two or three different Voices (Right 1, 2 and 3) simultaneously, or play different Voices in the right- and left-hand sections of the keyboard (Right 1/2/3 and Left). You can combine these parts by using the PART SELECT and PART ON/OFF buttons to create luscious instrument textures and convenient performance combinations.

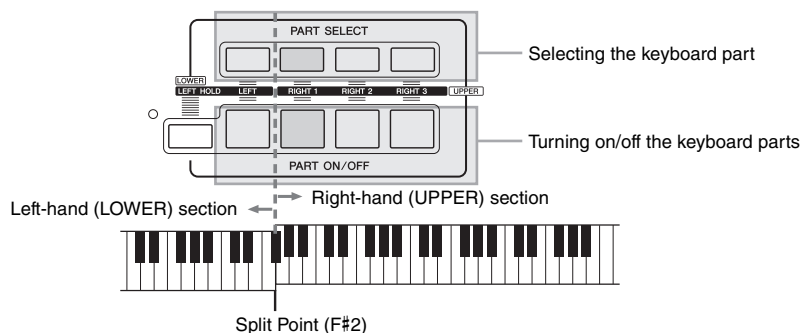

When the Left part is turned off, the entire keyboard is used for the Right 1, 2 and 3 parts. When the Left part is turned on, the F#2 and lower keys are used for the Left part while the upper keys (excluding F#2) are used for the Right 1, 2 and 3 parts. The key which divides the keyboard into the left-hand and right-hand sections is referred to as “Split Point.”

### NOTE

The Split Point can be changed (page 62).

### Holding the LEFT part Voice (Left Hold)

This function causes the LEFT part Voice to be held even when the keys are released. Non-decaying Voices such as strings are held continuously, while decay-type Voices such as piano decay more slowly (as if the sustain pedal has been pressed).

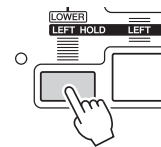

## Voice Characteristics

The Voice type and its defining characteristics are indicated above the Voice name. S.Art!, S.Art2!, MegaVoice, Live!, Cool!, Sweet!, etc.



### ● S.Art! and S.Art2! (Super Articulation Voices)

The word “articulation” in music usually refers to the transition or continuity between notes. This is often reflected in specific performance techniques, such as staccato, legato and slur. For details, refer to page 40.

### ● Drum Voices and SFX Voices (called up via the [DRUM KIT] button)

Lets you play various drums and percussion instruments or SFX (sound effects) sounds on the keyboard. Details are given in the “Drum/Key Assignment List” of the Data List. The Data List is available on the website.

For information about other Voice types, refer to the Reference Manual.

### NOTE

- S.Art! and S.Art2! Voices are only compatible with other models which have those types of Voices installed. Any Song, Style or Multi Pads data you've created on the instrument using these Voices will not sound properly when played back on other instruments.
- S.Art! and S.Art2! Voices sound differently depending on the keyboard range, velocity, touch, etc. Hence, if you apply a HARMONY/ECHO effect, change the transpose setting or change the Voice Set parameters, unexpected or undesired sounds may result.
- The characteristics of S.Art2! Voices (default vibrato setting and articulation effects applied by the [ART] buttons) are effective for real-time performance; however, these effects may not be completely reproduced when you play back a Song which has been recorded using S.Art2! Voices.

## Adding Articulation Effects to Super Articulation Voices

The Super Articulation Voices (S.Art! Voices and S.Art2! Voices) enable you to create subtle, very realistic musical expressions, by how you play. Moreover, with the [ART. 1]/[ART. 2] buttons in this instrument, you can add those expressions by simply pressing a single button.

When you select a Super Articulation Voice, the [ART. 1]/[ART. 2] buttons may light in blue. Pressing a lit button adds the effect (a button which is not lit has no effect).

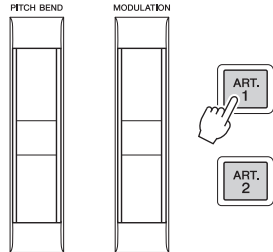

Below are three examples of Super Articulation effects.

### ● Example 1

Pressing the available [ART] button triggers different playing effects and techniques, separate from your keyboard playing. For example, pressing the [ART] button for a S.Art! saxophone Voice can produce breath noise or key noise, while doing the same for a S.Art! guitar Voice can produce fret noise or body-tapping sound. You can effectively intersperse these into the notes as you play.

While the articulation effect sounds, the button lights in red.

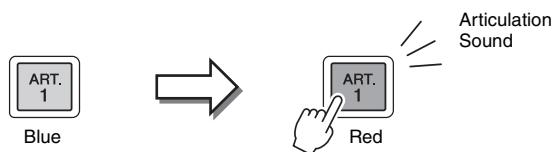

### ● Example 2

Playing the keyboard while holding down the available [ART] button changes the nature of the Voice. For example, in the case of the NylonGuitar Voice in A.GUITAR category, holding down the [ART. 1] button lets you play harmonics for the guitar Voice. Releasing the button returns the Voice to normal.

The button lights in red while it is being held down.



### NOTE

- For examples of adding effects by how you play, refer to the Voice characteristics for Super Articulation Voices on the Reference Manual.
- The applied articulation effect differs depending on the selected Voice. For details, refer to the Information display called up by pressing the [6 ▼] (INFO) button on the Voice Selection display.

### ● Example 3

When an S.Art2! Voice is selected, pressing the available [ART] button and playing/releasing a note enables you to add articulation effects, such as bend up/down, glissando up/down, brass fall, etc.

When you press the available [ART] button, it will flash in red until the effect is finished playing. You can cancel by pressing the button again while it flashes. Just after you press/release the note and articulation effect sounds, the button lights in red.

#### NOTE

Keeping with the realistic response of the original instruments, the effects applied vary depending on the range you are playing in.

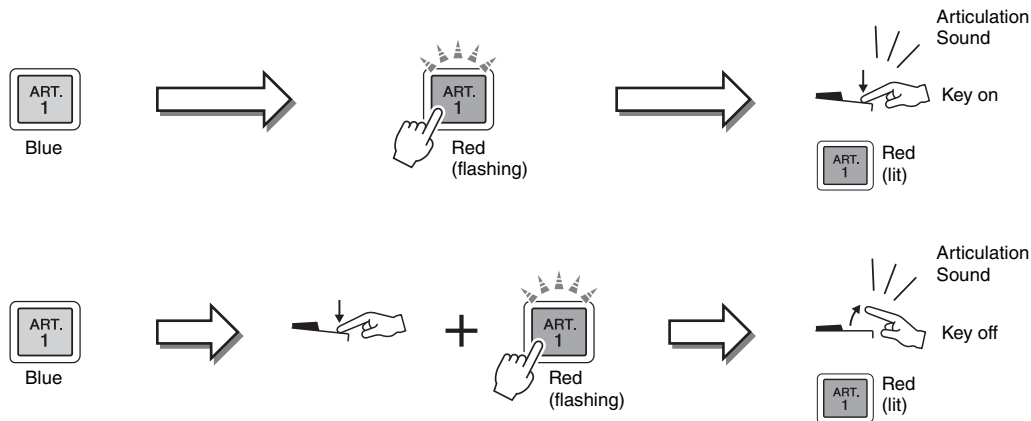

Example 3 effects can also be used in the same manner as Example 2. Holding an [ART] button (the button flashes in red) and playing/releasing a note enables you to add the articulation effect several times in succession.

#### **Notice for when Super Articulation Voices are selected for multiple parts**

When you select S.Art!/S.Art2! Voices for two or more keyboard parts, using an [ART] button simultaneously affects all parts on which S.Art!/S.Art2! Voices are selected.

When a Example 3 effect is assigned to both the Right and Left parts and an [ART] button flashes in red (standby status), playing only one part (for example, the Right 1 part) adds an articulation effect to only that part. Since the other part (Left part) is kept in standby status, the button continues flashing. To cancel the standby status, you need to play the keyboard in the Left part range. (Pressing the flashing button does not cancel standby status in this case, because this can cancel the standby of the Left part but turns the Right part to standby again.)

## Playing Various Organ Voices (Organ World)

The Tyros5 uses advanced digital technology to accurately and authentically reproduce the characteristic sounds of a variety of organs played throughout the world. Five basic types are provided, letting you play with full expression and true realism in various styles that feature organ sounds—from blues and jazz to classical and theatre.

Each organ type has its own display, which very beautifully recreates the actual appearance of an actual instrument. They feature convenient presets for instantly changing the sound. In particular, the Concert and Theatre types have powerful, dynamic sounds that effectively reproduce not only the instruments themselves but also the huge venues in which they are played. Moreover, the Vintage, Home and Euro types also provide realistic, intuitive control over the sound with special footage levers, tabs and switches—letting you adjust the sound with much the same feel as on an actual instrument.



- 1 Press the [ORGAN WORLD] button to call up the Organ World display.



- 2 Use the TAB [◀][▶] buttons to select the type of organ which you want to play.

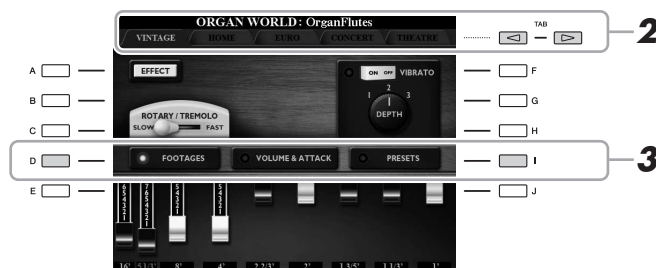

If you selected the CONCERT or the THEATRE, go to step 4.

- 3 Press the [I] button several times until the Preset Select display is called up.

## 4 Use the [1 ▲▼]–[8 ▲▼] buttons to select the desired preset.

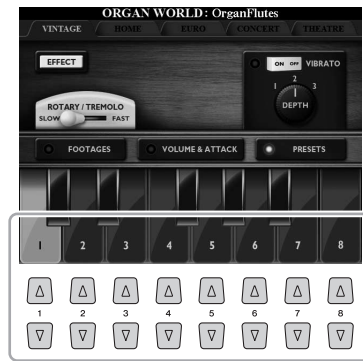

## 5 Play the keyboard.

### Adjusting the Footage Levels (only for Vintage, Home and Euro)

The Vintage, Home and Euro types also give you access to an unlimited combination of organ sounds, by letting you change the footage levels on the FOOTAGES display. The footage levels are changed directly by using the [ASSIGN] slider and the [1]–[8] sliders.

To call up the FOOTAGES display, press the [D] button once or twice on the display of each organ type.

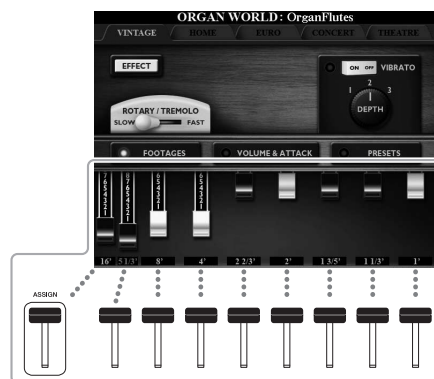

For more operations, see the Reference Manual on the website.

#### NOTE

You can also use the [1 ▲▼]–[8 ▲▼] buttons to adjust the footage levels.

#### NOTE

The term “footage” is a reference to the sound generation of traditional pipe organs, in which the sound is produced by pipes of different lengths (in feet).

#### NOTE

When the FOOTAGES display of Vintage/Euro type is shown, the function normally assigned to the [ASSIGN] slider cannot be controlled. The [ASSIGN] slider works only to adjust the 16' footage level.

## Playing Ensemble Voices

These are special Voice settings that feature multiple Voices, used in realistic ensemble combinations, such as brass section and string quartet. Up to four special parts or instruments are provided within a single Voice. But rather than just being a combination, the parts are dynamically assigned to the notes, and are distributed among the intervals you play in exceptionally natural, musical ways—as if four different players were actually playing the parts live. Moreover, the discrepancy between each instrument—the pitch, timing, etc.—can be controlled and “humanized,” making the overall sound amazingly authentic and expressive.

### 1 Press the [ENSEMBLE] button to engage the Ensemble Voice mode.

In this mode, the Keyboard parts (L, R1, R2 and R3) will be changed to special Ensemble Parts 1–4 respectively. Since all the Ensemble Parts are handled as Right parts, the Left hand part is not available in this mode, although the Auto Accompaniment can be turned on and Styles can be played with the left hand.

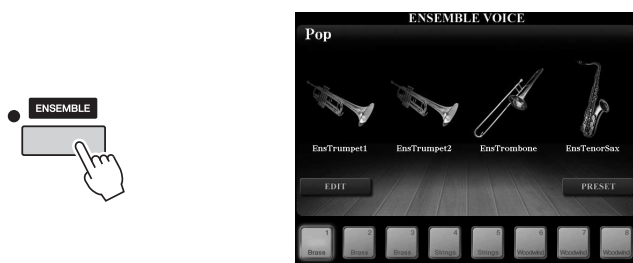

### 2 Press one of the [1 ▲▼]–[8 ▲▼] buttons to select the desired Ensemble Voice.

From all the Preset Ensemble Voices, the most recommended eight Voices can be selected on this display.

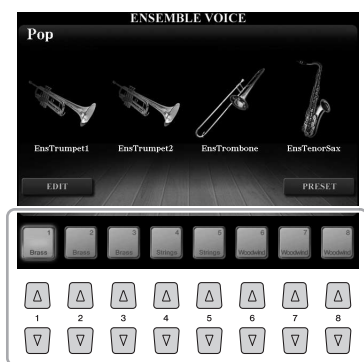

### 3 Play the keyboard.

Depending on your playing, up to four different Voices will be sounded alternatively or simultaneously. For example, when you play a chord, each successively played note will trigger a different Voice, creating a highly realistic ensemble sound. Try all eight Ensemble Voices and enjoy!

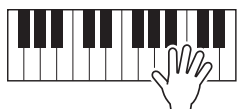

#### NOTICE

Engaging the Ensemble Voice mode erases the Voice combination settings (L, R1, R2 and R3). Important panel settings should be memorized to the Registration Memory (page 85).

#### NOTE

You can edit settings, such as changing each of the Voices that make up the Ensemble Voice and change how the Voices are assigned the notes of the chords you play. For details, refer to the Reference Manual on the website.



**If you want to enjoy more Ensemble Voices:**

From the ENSEMBLE VOICE display, press the [J] (PRESETS) button to call up the Ensemble Voice selection display, then select the desired one from various Preset Ensemble Voices (other than the eight described above). To return to the ENSEMBLE VOICE display, press the [EXIT] button.

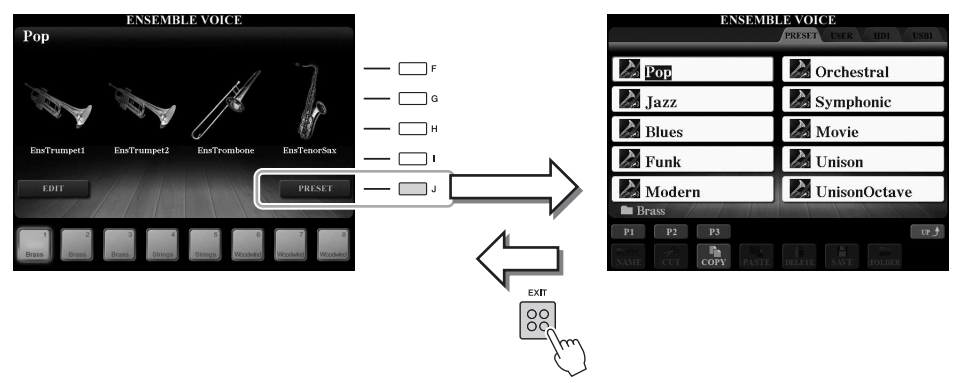

**If you want to return to the MAIN display:**

From the ENSEMBLE VOICE display, press the [EXIT] button. The Voice area shows the Ensemble Voice name. To call up the ENSEMBLE VOICE display again, press one of the [F]–[I] buttons.

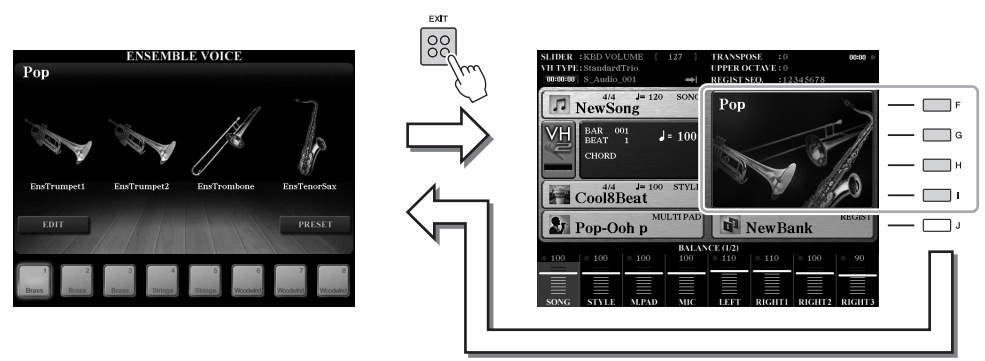

**4 To exit from the Ensemble Voice mode, simply select a Voice other than the Ensemble Voice.**

Press one of the VOICE buttons other than the [ENSEMBLE] button, then press one of the [A]–[J] buttons to select the desired Voice. To confirm that Ensemble Voice mode is no longer active, press the [EXIT] button to return to the MAIN display and check that the Voice area shows four different Voice names.

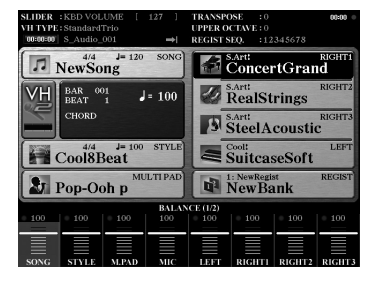

## Transposing the Pitch

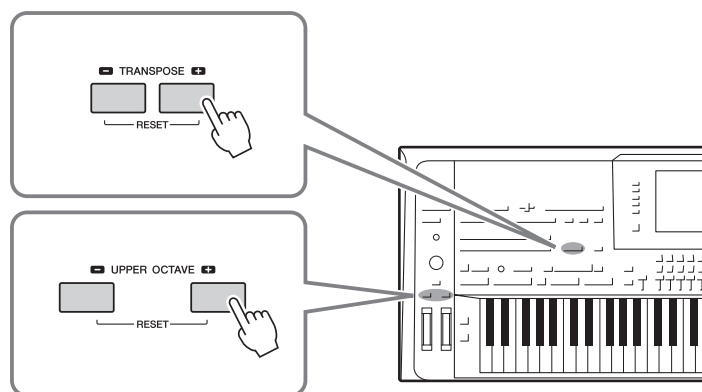

### Using the TRANSPOSE [-]/[+] buttons

The TRANSPOSE [-]/[+] buttons transpose the overall pitch of the instrument (the keyboard sound, Style playback, MIDI Song playback, and so on) in semitone steps. To instantly reset the transpose value to 0, press the [+] and [-] buttons simultaneously.

#### **NOTE**

The Transpose functions do not affect the Drum Kit or SFX Kit Voices.

You can independently select the part (Keyboard, MIDI Song and Master) to transpose as desired from the display called up via [FUNCTION] → [D] CONTROLLER → TAB [◀][▶] KEYBOARD/PANEL. For instructions, refer to the Reference Manual.

### Using the UPPER OCTAVE [-]/[+] buttons

The UPPER OCTAVE [-]/[+] buttons allow you to shift the pitch of the RIGHT 1–3 parts up or down by one octave. To instantly reset the octave value to 0, press the [+] and [-] buttons simultaneously.

#### **Transposing the pitch in the MIXING CONSOLE display**

You can also make detailed pitch settings (transpose, octave and tune) in the MIXING CONSOLE display called up via [MIXING CONSOLE] → TAB [◀][▶] TUNE. For details, refer to page 93.

### Fine tuning the Pitch

By default, the pitch of the entire instrument is set to 440.0 Hz with the Equal Temperament. This basic tuning can be changed in the display called up via [FUNCTION] → [A] MASTER TUNE/SCALE TUNE. For details, refer to the Reference Manual on the website.

## Using the Wheels

### Using the Pitch Bend Wheel

Use the PITCH BEND wheel to bend notes up (roll the wheel away from you) or down (roll the wheel toward you) while playing the keyboard. Pitch Bend is applied to all keyboard parts (RIGHT 1–3 and LEFT). The PITCH BEND wheel is self-centering and will automatically return to normal pitch when released.

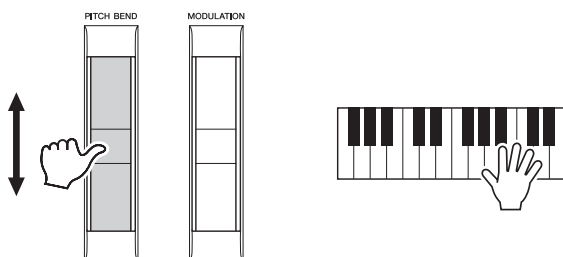

The maximum pitch bend range can be changed on the Mixing Console display: [MIXING CONSOLE] → TAB [◀][▶] TUNE → [C]/[H] PITCH BEND RANGE.

### Using the Modulation Wheel

The Modulation function applies a vibrato effect to notes played on the keyboard. By default, this is applied to the keyboard parts (RIGHT 1–3). Moving the MODULATION wheel down (toward you) decreases the depth of the effect, while moving it up (away from you) increases it.

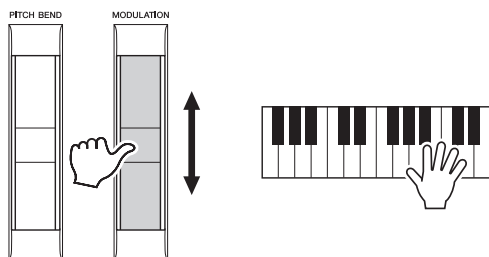

You can set whether the effects produced by using the MODULATION Wheel will be applied or not to each of the keyboard parts: [FUNCTION] → [D] CONTROLLER → TAB [◀][▶] KEYBOARD/PANEL → [A]/[B] 3 MODULATION WHEEL.

#### NOTE

The effects produced by using the PITCH BEND Wheel may not be applied to the LEFT part during Style playback, depending on the Style setting.

#### NOTE

Depending on the selected Voice, the MODULATION wheel may control volume, filter or some other parameter instead of vibrato.

#### NOTE

To avoid accidentally applying modulation, make sure the MODULATION Wheel is set at minimum (down) position before you start playing.

#### NOTE

The effects produced by using the MODULATION wheel may not be applied to the LEFT part during Style playback, depending on the Style setting.

## Applying Voice Effects

You can apply various effects to enhance or change the sound of the keyboard parts (Left, Right 1, 2 and 3). The effects can be turned on or off by using the following buttons.

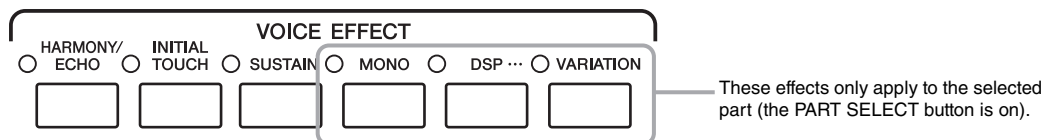

### ● HARMONY/ECHO ... page 49

This applies appropriate harmony notes to the notes played in the Right-hand section.

### ● INITIAL TOUCH

This button turns the touch response of the keyboard on or off. When off, the same volume is produced no matter how strongly or softly you play the keyboard.

### ● SUSTAIN

When this Sustain function is on, all notes played on the keyboard with right-hand part (RIGHT 1, 2, 3) have a longer sustain.

### ● MONO

When this button is on, the part's Voice is played monophonically (only one note at the time) with last note priority, letting you play single, lead sounds such as brass instruments more realistically. Depending on the Voice, Portamento may be produced when notes are played with legato.

When this button is off, the part's Voice played polyphonically.

### ● DSP/DSP VARIATION

With the digital effects built into the instrument, you can add ambience and depth to your music in a variety of ways—such as adding reverb that makes you sound like you are playing in a concert hall.

The [DSP] button is used to turn the DSP (Digital Signal Processor) effect on or off for the currently selected keyboard part.

The [VARIATION] button is used to change between variations of the DSP effect. For example, this could be used to change the rotating speed (slow/fast) of the rotary speaker effect while you play.

#### NOTE

Portamento is a function that creates a smooth transition in pitch from the first note played on the keyboard to the next.

#### NOTE

The effect type can be changed. On the Voice Selection display, select [5 ▼] (VOICE SET) → TAB [◀|▶] EFFECT/EQ → [A]/[B] 2 DSP.

# Applying Harmony to Notes Played in the Right-hand Section (HARMONY/ECHO)

Among the Voice effects, Harmony is one of the most dramatic and musically useful. It automatically applies appropriate harmony notes to the notes played in the Right-hand section.

## 1 Turn the [HARMONY/ECHO] button on.

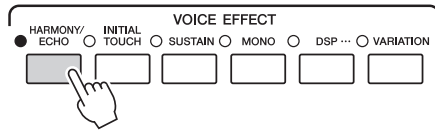

## 2 Turn on both the [ACMP] button and [SYNC START] button (pages 51–52) and make sure that the RIGHT 1 part is on (page 36).

### NOTE

Depending on the harmony/echo type, harmony will be applied even when the [ACMP] button is off.

## 3 Play a chord with your left hand to start the Style (page 52) and play some notes in the right-hand section of the keyboard.

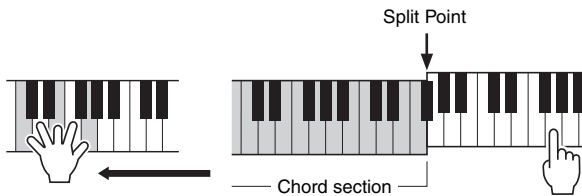

In this example, harmony notes in the scale of C major (the chord played in the left hand) are automatically added to the notes played in the right-hand range of the keyboard.

You can also use the Harmony effect without Style playback. Make sure the [ACMP] button is on, then simply hold down a chord with your left hand and play a melody with your right.

Many of the Voices have been automatically set to play certain Harmony/Echo types that match the particular Voice. Try out some of Voices. You can also change the Harmony/Echo type: [FUNCTION] → [F] HARMONY/ECHO. For details, refer to the Reference Manual on the website.

## Adding New Contents—Expansion Packs

Installing an Expansion Pack lets you add a variety of optional Voices and Styles. The installed Voices and Styles can be selected like Preset Voices and Styles, allowing you to expand your music performance and creation possibilities. Moreover, it is very easy to manage and install the Packs by using special software on your computer. You can purchase high quality Expansion Pack data created by Yamaha (called Premium Pack), or create your own original Expansion Pack data by using special software on your computer.

For more information, access the Tyros5 page at the Yamaha Music Soft website:  
<http://www.yamahamusicsoft.com/>

### **IMPORTANT**

If you want to install Expansion Voices, make sure to install the optional Flash Memory Expansion Module (pages 108–109). Among the Expansion Pack data, the data of the Expansion Voices, Songs, Styles, etc. will be installed to the internal hard disk (HD) drive, while the Waves making up the Voices will be installed to the optional Flash Memory Expansion Module.

### **NOTE**

You can also expand contents other than Voices and Styles. For more information, access the Yamaha Music Soft website.

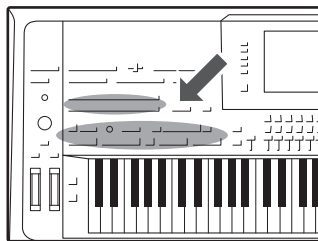

The Tyros5 features a variety of accompaniment and rhythmic backing patterns (called “Styles”) in a variety of different musical genres including pop, jazz, and many others. The Style features Auto Accompaniment, letting you produce automatic accompaniment playback simply by playing “chords” with your left hand. This lets you automatically recreate the sound of a full band or orchestra—even if you’re playing by yourself.

### Playing a Style with the Auto Accompaniment

- 1 Press one of the STYLE buttons to call up the Style Selection display.

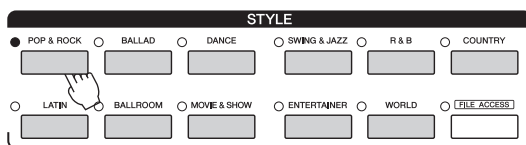

- 2 Press one of the [A]–[J] buttons to select the desired Style.

You can call up the other pages by pressing the buttons that correspond to the page numbers (P1, P2, etc.) or by pressing the same STYLE button several times.

- 3 Press the [ACMP] button to turn on the Auto Accompaniment.

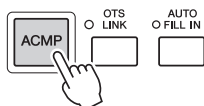

The specific left-hand section of the keyboard (page 38) becomes the Chord section, and chords played in this section are automatically detected and used as a basis for fully automatic accompaniment with the selected Style.

#### NOTE

The Style Selection display lets you memorize the path of a specific Style to one of the panel buttons. For information on memorizing Style paths, refer to page 28.

## 4 Press the [SYNC START] button to enable synchronized start.

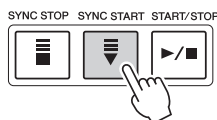

## 5 As soon as you play a chord with your left hand, the selected Style starts.

Try playing chords with your left hand and play a melody with your right hand.



## 6 Press the [START/STOP] button to stop Style playback.

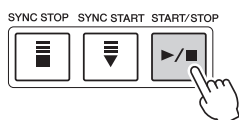

### NOTE

For information on chords and the Chord Fingering Type, refer to page 55.

### NOTE

For instructions on transposing the Style, refer to page 46.

### NOTE

Although the chord will be detected according to the notes you play in the left hand section by default, you can change the chord detection area from the left hand section to the right hand section. For details, refer to page 63.

### Style Characteristics

At the left side of each Style name in the Style Selection display, the Style type and its defining characteristic is indicated. There are various Style characteristics; however, only the audio Style (shown as “+Audio” in the display) is covered here. For information on others, refer to the Reference Manual on the website.

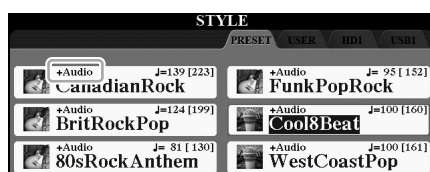

- **Audio Styles:** The audio Styles (+Audio) have been specially produced by adding audio recordings of studio musicians playing in various recording studios worldwide. This adds all the natural feel, ambience and warmth to the drums and percussion of the Style, giving your performance greater expressive potential. Specifically, it retains the subtle nuances and grooves that are difficult to reproduce using the preset drum/percussion kit. Yamaha Time Stretch Technology allows the audio to follow your tempo changes without changing pitch, so everything stays in perfect sync.

### NOTE

- If the tempo is set to over 160% of the default, the audio part is muted.
- Keep in mind that the audio Styles may take more time to load than others, and that they may have certain restrictions and differ in the specific functions that can be handled.

### Style file compatibility

The Tyros5 uses the SFF GE file format (page 11). The Tyros5 can play back existing SFF files, but they will be saved in the SFF GE format when the file is saved (or pasted) in the Tyros5. Please keep in mind that the saved file can only be played back on instruments that are compatible with the SFF GE format.



# Operating Style Playback

## To Start/Stop Playing

### ● [START/STOP] button

Starts playback of the rhythm part of the current Style. To stop playback, press the button again.



### Playing back both rhythm and auto accompaniment

If you turn on the [ACMP] button, both the rhythm part and auto accompaniment can be played back when playing chords in the chord section during Style playback.



### ● [SYNC START] button

This puts the Style playback in “standby.” The Style starts playing back when you press any note on the keyboard (when [ACMP] is off) or you play a chord with your left hand (when [ACMP] is on). While a Style is playing back, pressing this button stops the Style and puts playback in standby.



### ● [SYNC STOP] button

You can start and stop the Style anytime you want by simply playing or releasing the keys in the chord section of the keyboard. Make sure that the [ACMP] button is on, press the [SYNC STOP] button, then play the keyboard.



#### NOTE

When the Fingering type (page 55) is set to “Full Keyboard” or “All Full Keyboard,” Sync Stop cannot be turned on.

### ● INTRO [I]–[III] buttons

The Tyros5 features three different Intro sections to add an introduction before starting the Style playback. After pressing one of the INTRO [I]–[III] buttons, start playback of the Style. When the Intro finishes playing, the Style playback automatically shifts to the Main section.

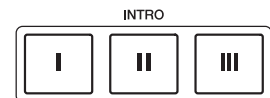

### ● ENDING/rit. [I]–[III] buttons

The Tyros5 features three different Ending sections to add an ending before stopping Style playback. When you press one of the Ending [I]–[III] buttons while Style is playing back, the Style will automatically stop after the ending is played. You can have the ending gradually slow down (ritardando) by pressing the same ENDING button once again, while the ending is playing.

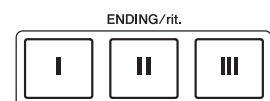

## Changing Pattern Variation (Sections) During Style playback

Each Style features four different Main sections, four Fill-in sections and a Break section. By using these sections effectively, you can easily make your performance sound more dynamic and professional. The section can be freely changed while the Style is playing back.

## ● MAIN VARIATION [A]–[D] buttons

Press one of the MAIN VARIATION [A]–[D] buttons to select the desired Main section (the button lights in red). Each is an accompaniment pattern of a few measures or more and it plays indefinitely. Pressing the selected MAIN VARIATION button again plays an appropriate fill-in pattern to spice up the rhythm and break the repetition. After the fill-in finishes playing, it leads smoothly into the Main section.

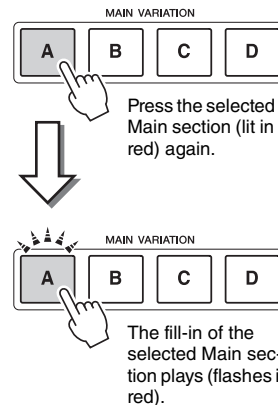

### AUTO FILL function

When the [AUTO FILL IN] button is turned on, pressing any of the MAIN VARIATION [A]–[D] buttons as you play automatically plays a fill-in section for a smooth, dynamic transition into the next (or same) section.



## ● [BREAK] button

This lets you add dynamic breaks in the rhythm of the accompaniment. Press the [BREAK] button during Style playback. When the one-measure Break pattern finishes playing, Style playback automatically shifts to the Main section.



### About the lamp status of the section buttons (INTRO/MAIN VARIATION/BREAK/ENDING)

- **Red:** The section is currently selected.
- **Red (flashing):** The section will be played next, following the currently selected section.  
\*The MAIN VARIATION [A]–[D] button lamps also flash in red when the fill-in is playing.
- **Blue:** The section contains data but not currently selected.
- **Off:** The section contains no data and cannot be played.

## Adjusting the Tempo

The TEMPO [-] and [+] buttons let you change the playback tempo of Metronome, Style and MIDI Song. The tempo of the Style and MIDI Song can also be adjusted via the [TAP TEMPO] button.

### NOTE

If you want to adjust the tempo of an Audio Song, use the Time Stretch function on page 80.



## ● TEMPO [-]/[+] buttons

Press the TEMPO [-] or [+] button to call up the Tempo pop-up display. Use the TEMPO [-]/[+] buttons to decrease or increase the tempo over a range of 5–500 beats per minute. Holding down either button can change the value continuously. Pressing both TEMPO [-] and [+] buttons can call up the default tempo of the last selected Style or Song.



## ● [TAP TEMPO] button

During playback of a Style or MIDI Song, you can change the tempo by tapping the [TAP TEMPO] button twice at the desired tempo. When Style and Song are stopped, tapping the [TAP TEMPO] button (four times for a 4/4 time signature) starts playback of the rhythm part of the Style at the tempo you tapped.

## Fading In/Out

### ● [FADE IN/OUT] button

This produces smooth fade-ins and fade-outs when starting/stopping the playback of Style and MIDI Song. Press the [FADE IN/OUT] button when playback is stopped and press the [START/STOP] button for Style (or the [PLAY/PAUSE] button for MIDI Song) to start playback with a fade in. To stop the playback with a fade out, press the [FADE IN/OUT] button during playback.



# Chords

For users who are unfamiliar with chords, this handy chart features common chords for your quick reference. Since there are many useful chords and many different ways to use them musically, refer to commercially available chord books for further details.

★ Indicates the root note.

Major	Minor	Seventh	Minor Seventh	Major Seventh
<b>C</b> 	<b>Cm</b> 	<b>C7</b> 	<b>Cm7</b> 	<b>CM7</b> 
<b>D</b> 	<b>Dm</b> 	<b>D7</b> 	<b>Dm7</b> 	<b>DM7</b> 
<b>E</b> 	<b>Em</b> 	<b>E7</b> 	<b>Em7</b> 	<b>EM7</b> 
<b>F</b> 	<b>Fm</b> 	<b>F7</b> 	<b>Fm7</b> 	<b>FM7</b> 
<b>G</b> 	<b>Gm</b> 	<b>G7</b> 	<b>Gm7</b> 	<b>GM7</b> 
<b>A</b> 	<b>Am</b> 	<b>A7</b> 	<b>Am7</b> 	<b>AM7</b> 
<b>B</b> 	<b>Bm</b> 	<b>B7</b> 	<b>Bm7</b> 	<b>BM7</b> 

## Changing the Chord Fingering Type

By changing the chord fingering type, you can automatically produce appropriate accompaniment even if you don't press all of the notes which comprise a chord. Chord fingering type can be changed via: [FUNCTION] → [C] STYLE SETTING/SPLIT POINT/CHORD FINGERING → TAB [◀][▶] CHORD FINGERING.

Following types can be selected, for example.

### ● Single Finger

This method lets you easily play chords in the accompaniment range of the keyboard using only one, two or three fingers.



**Major chord**

Press the root key only.



**Minor chord**

Simultaneously press the root key and a black key to its left.



**Seventh chord**

Simultaneously press the root key and a white key to its left.



**Minor seventh chord**

Simultaneously press the root key and both a white and black key to its left.

### ● AI Full Keyboard

This lets you play just about anything, anywhere on the keyboard using both hands—like conventional playing of a piano—and still have appropriate accompaniment. You don't have to worry about specifying the chords. (Depending on the song arrangement, AI Full Keyboard may not always produce appropriate accompaniment.)

For other types, refer to the Reference Manual on the website.

# Calling up Appropriate Panel Settings for the Current Style (One Touch Setting)

One Touch Setting is a powerful and convenient feature that automatically calls up the most appropriate panel settings (Voices and effects, etc.) for the currently selected Style, with the touch of a single button. If you've already decided which Style you wish to use, you can have One Touch Setting automatically select the appropriate Voice for you.

## NOTE

For information on the panel settings that are called up by One Touch Setting, Refer to the OTS section of "Parameter Chart" in the Data List. The Data List is available on the website.

### 1 Select a Style (steps 1–2 on page 51).

### 2 Press one of the ONE TOUCH SETTING [1]–[4] buttons.

Not only does this instantly call up all the settings (Voices, effects, etc.) that match the current Style, it also automatically turns on ACMP and SYNC START, so that you can immediately start playing the Style.

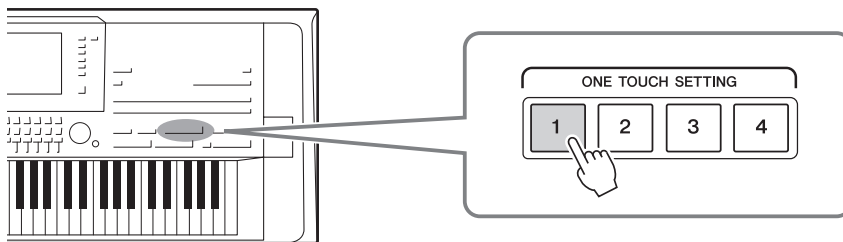

#### Confirming the One Touch Setting contents

In the Style Selection display, press the [6 ▼] (OTS INFO) button to call up the Information window that shows what Voices are assigned to the ONE TOUCH SETTING [1]–[4] buttons for the current Style.

#### NOTE

Gray color for a Voice name in the window indicates that the corresponding Voice part is currently turned off.

To close the window, press the [F] (CLOSE) button.

### 3 As soon as you play a chord with your left hand, the selected Style starts.

Each Style has four One Touch Setting setups. Press the other ONE TOUCH SETTING [1]–[4] buttons to try out other setups.

## NOTE

You can memorize original settings to One Touch Setting. For instructions, refer to the Reference Manual on the website.

#### Automatically changing One Touch Settings with the Main sections

The convenient OTS (One Touch Setting) Link function lets you automatically have One Touch Settings change when you select a different Main section (A–D). The Main sections A, B, C and D correspond to One Touch Settings 1, 2, 3 and 4 respectively. To use the OTS Link function, turn the [OTS LINK] button on.

#### NOTE

You can change the timing in which the One Touch Settings change with MAIN VARIATION [A]–[D] change. For instructions, refer to the Reference Manual on the website.

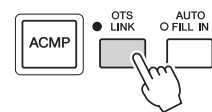

## Searching for Suitable Songs for the Current Style (Repertoire)

You can search for music pieces and songs that are most suitable for playing with the current Style by using the Music Finder Records (page 82). You can automatically call up appropriate settings such as Voice, effect and pedal by selecting the desired music piece.

For optimum use of the Repertoire function, we recommend that you import Music Finder Records (page 81).

**1** Select the desired Style (steps 1–2 on page 51).

**2** Press the [4 ▼] (REPETOIRE) button.

The MUSIC FINDER display is automatically called up, and the music pieces which can be played with the current Style are shown.

**NOTE**

Make sure that MENU 1 is shown at the bottom right corner of the display (page 26).

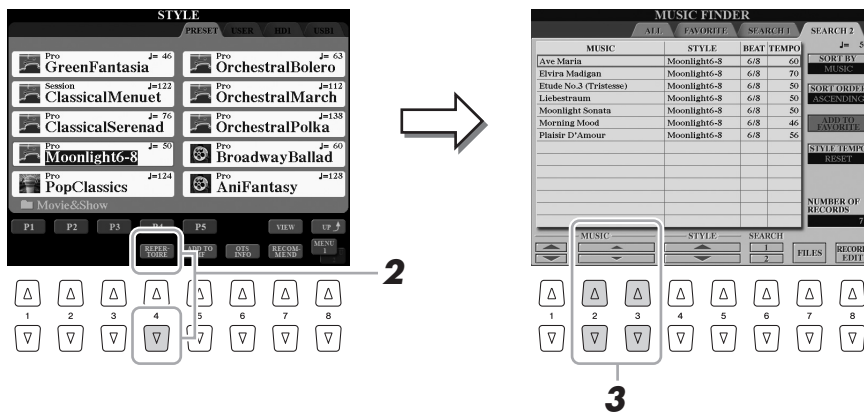

**3** Use the [2 ▲▼]–[3 ▲▼] buttons to select the desired music piece (Record).

The appropriate panel settings for playing the music piece are called up.

**NOTE**

Depending on the particular selected Style, there may not be any music piece available.

2

Styles – Playing Rhythm and Accompaniment –

## Calling up Optimum Styles for Your Performance (Style Recommender)

This convenient function “recommends” optimum Styles for the song you want to perform, based on the rhythm you play for one or two measures.

### 1 In the Style selection display (page 51), press the [7 ▼] (RECOMMEND) button to call up the STYLE RECOMMENDER display.

The keyboard is divided at the B1 key into two sections as below.

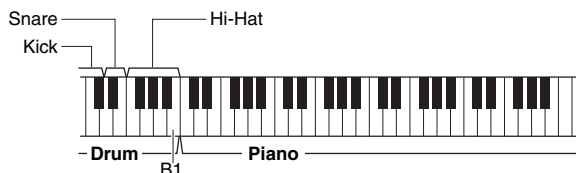

The Drum instruments (Kick, Snare and Hi-Hat) are assigned to the left of the B1 key while the Piano sound is assigned to the right.

The instruments assigned to the keys differ slightly between the keyboard with 76 and 61 keys as follows:

#### Tyros5-76

Keys	Instruments
E0–C#1	Kick
D1–E1	Snare
F1–B1	Hi-Hat
C2–G6	Piano

#### Tyros5-61

Keys	Instruments
C1–C#1	Kick
D1–E1	Snare
F1–B1	Hi-Hat
C2–C6	Piano

## 2 Use the Style Recommender function to find the Style.

**2-1** Press [I] (START) button to start the metronome, indicating that the Style Recommender function starts.

Pressing the [I] button toggles between START and CANCEL.

As necessary, use the TEMPO [-]/[+] buttons or [TAP TEMPO] button to adjust the tempo, and press the [D] (METRONOME) button on the display to select the beat.

**2-2** Play the rhythm you have in mind on the Drum or Piano section for one or two measures along with the metronome.

The timing at which you play the keys is analyzed over several seconds, then playback of the most recommended Style starts. In addition, the candidates of the other recommended Styles are listed in the display.

**Example 1: Play the following rhythm on the Piano section.**



Bossa Nova Styles or those of a similar feel may be listed in the display.

**Example 2: Play the following rhythm on the Drum section.**



8-beat Styles or those of a similar feel may be listed in the display.

#### NOTE

The instrument only analyzes the timing of your keyboard play. The strength at which you play a key, the length at which you hold it, and the pitches of the sounds themselves are all ignored.

**3 Select the desired Style from the list by using the [2 ▲▼]– [7 ▲▼] buttons.**

Listen to the Styles by changing the sections (page 53), playing chords on the Piano section and adjusting the tempo (page 54).

If the Style called up doesn't match the song you want to play, press the [I] (RETRY) buttons, then return to step 2-2.

**4 When you've found a Style you're satisfied with, press the [8 ▲▼] (OK) button to exit from the STYLE RECOMMENDER display.**

**5 Play the keyboard along with the Style you just found.**

## Turning Each Channel of the Style On/Off

Each Style contains the channels listed below. You can add variations and change the feeling of a Style by selectively turning channels on/off as the Style plays.

### ● Style channels

- **RHY1/2 (Rhythm 1/2)**.....These are the basic parts of the Style, containing the drum and percussion rhythm patterns.
- **BASS**.....The bass part uses various appropriate instrument sounds to match the Style.
- **CHD1/2 (Chord 1/ 2)**.....These are the rhythmic chord backing, commonly consisting of piano or guitar Voices.
- **PAD** .....This part is used for sustained instruments such as strings, organ, choir, etc.
- **PHR1/2 (Phrase1/2)** .....These parts are used for punchy brass stabs, arpeggiated chords, and other extras that make the accompaniment more interesting.
- **AUDIO** .....This is an audio part exclusive to Audio Styles (page 52).

### 1 Press the [CHANNEL ON/OFF] button repeatedly if necessary to call up the CHANNEL ON/OFF (STYLE) display which contains the desired channel.

There are two pages, 1/2 and 2/2 for Style channels.

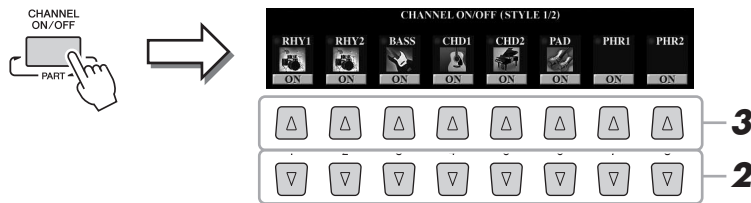

### 2 Press the [1 ▼]–[8 ▼] buttons to turn the channels on or off.

To listen to only one channel by itself, press and hold the appropriate button for the channel to set the channel to SOLO. To cancel SOLO, simply press the appropriate channel button again.

#### NOTE

You can save the settings here to Registration Memory (page 85).

#### To change the Voice for each channel

Press the [1 ▲]–[8 ▲] buttons of the corresponding channel to call up the Voice Selection display (page 36), then select the desired Voice.

#### NOTE

The Audio channel does not have a Voice and, hence, cannot be changed.

Changing the Voice can be done also from the VOL/VOICE page of the MIXING CONSOLE display (page 93).

### 3 Press the [EXIT] button to close the CHANNEL ON/OFF display.



## Adjusting the Volume Balance Between the Parts

You can adjust the volume balance between the parts (entire MIDI Song, entire Style, Multi Pads, MIC, Left, Right 1–3, Audio Song, AUX IN, entire keyboard). For the CENTER parameter, refer to “Adjusting the volume balance between the MIDI Song and Audio Song” below.

- 1 Press the [BALANCE] button once or twice to call up the desired page of the BALANCE display which contains the desired channel.

There are two pages, 1/2 and 2/2.

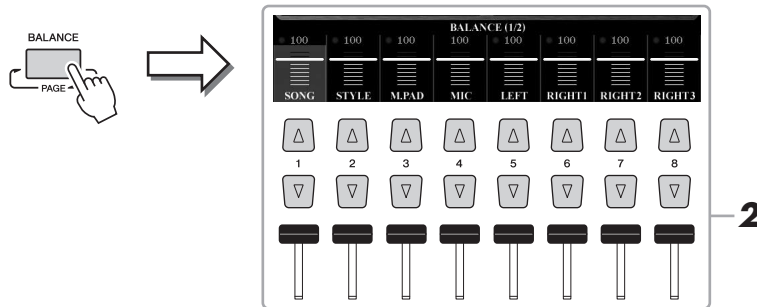

- 2 Press the [1 ▲▼]–[8 ▲▼] buttons or sliders to adjust the volume of the desired parts.

### Adjusting the volume balance between the MIDI Song and Audio Song

In the BALANCE 2/2 page, you can adjust the volume balance between the MIDI Song and Audio Song by using the [2 ▲▼]–[3 ▲▼] buttons. When this is set to CENTER, the levels of the MIDI Song and Audio Song are equal. To instantly reset the balance to CENTER, press the [2 ▲▼] and [3 ▲▼] buttons simultaneously.



You also can adjust the volume balance between the MIDI Song and Audio Song directly by using the Cross Fader.

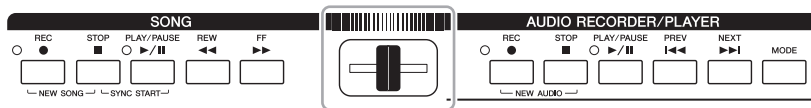

- 3 Press the [EXIT] button to close the BALANCE display.

#### NOTE

On the VOL/VOICE page of the MIXING CONSOLE display (page 93), you can adjust the volume for each of MIDI Song and Style parts.

# Setting the Split Point

The key which divides the keyboard into two sections is referred to as “Split Point.” These are three Split Points: Split Point (LEFT), Split Point (RIGHT 3), and Split Point (STYLE).

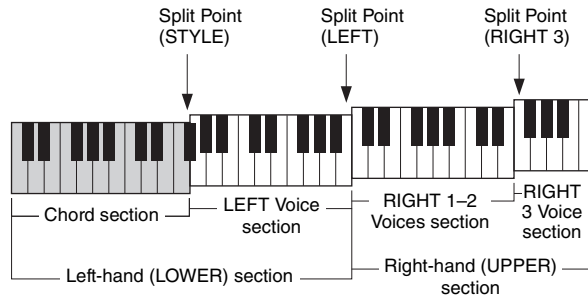

- **Split Point (LEFT):** ..... Divides the keyboard into the left-hand (LOWER) section and the right-hand (UPPER) section.
- **Split Point (RIGHT 3):**..... Divides the right-hand (UPPER) section into the RIGHT 1-2 Voices section and the RIGHT 3 Voice section.
- **Split Point (STYLE):**..... Divides the left-hand (LOWER) section into the Chord section and the LEFT Voice section.

## 1 Call up the Split Point display.

[FUNCTION] → [C] STYLE SETTING/SPLIT POINT/CHORD FINGERING → TAB [◀|▶] SPLIT POINT

## 2 Set the Split Point.

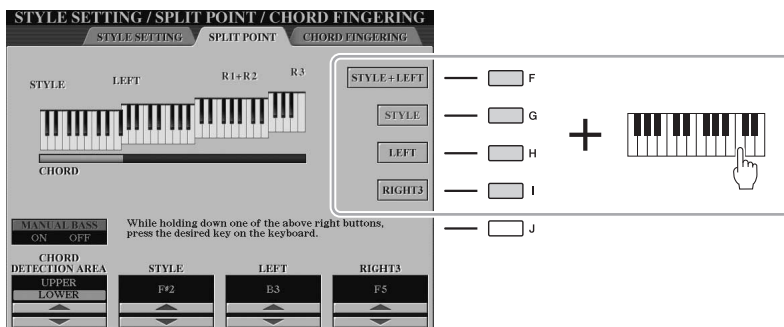

### NOTE

You also can specify each Split Point by note name, using the [3 ▲▼]–[8 ▲▼] buttons. Split Point (STYLE) is indicated by “STYLE,” Split Point (LEFT) is indicated by “LEFT,” and Split Point (RIGHT 3) is indicated by “RIGHT 3.”

[F]	Split Point (STYLE + LEFT)	Sets Split Point (STYLE) and Split Point (LEFT) to the same note. Press the [F] button and rotate the [DATA ENTRY] dial. You can also specify the Split Point directly from the keyboard by pressing the desired key on the keyboard while holding the [F] button.
[G]	Split Point (STYLE)	Sets each Split Point individually. Press one of the desired buttons and rotate the [DATA ENTRY] dial. You can also specify the Split Point directly from the keyboard by pressing the desired key on the keyboard while holding one of the [G]–[I] buttons.
[H]	Split Point (LEFT)	
[I]	Split Point (RIGHT 3)	

### NOTE

Split Point (LEFT) cannot be set lower than Split Point (STYLE), and Split Point (RIGHT 3) cannot be set lower than Split Point (LEFT).

# Specifying Chords with Your Right Hand while Playing Bass with Your Left Hand

By changing the Chord Detection area from the left-hand section to the right-hand section, you can play the bass line with your left hand while using your right hand to control Style playback.

To do this, set the CHORD DETECTION AREA value to “UPPER” via the [1 ▲] button on the Split Point display.

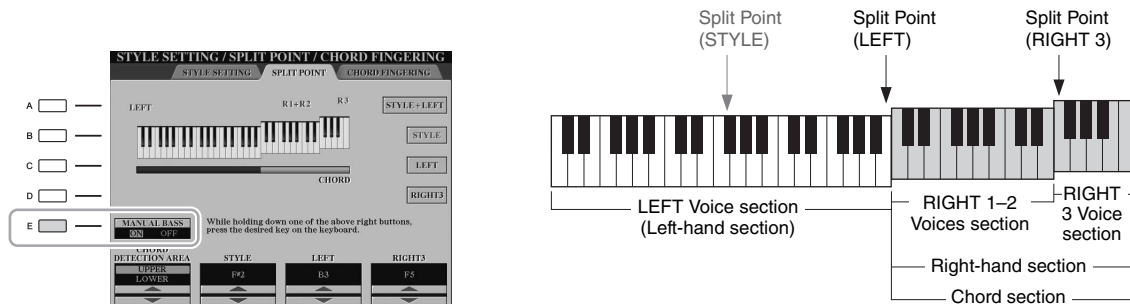

With this setting, the whole right-hand (UPPER) section works as the Chord section as well as melody performance. In this condition, note the following points:

- In the right-hand (UPPER) section, you can specify the chord type as you play the melody.
- The Bass Part Voice of the current Style is assigned to the Keyboard LEFT part. This is referred to as the Manual Bass function which can be turned off or on via the [E] button.
- The setting of the Chord Fingering Type (page 55) will be set to a special one (“FIN-GERED \*”) automatically, in which you should press three or more notes simultaneously for specifying the chord. Pressing two or less notes does not change the chord type.
- Split Point (STYLE) becomes unavailable.

**NOTE**

The CHORD DETECTION AREA value is set to “LOWER” automatically when the Ensemble Voice is selected.

# 3

# Multi Pads

– Adding Musical Phrases to Your Performance –

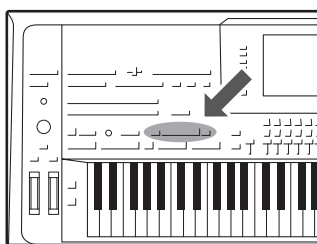

The Multi Pads can be used to play a number of short pre-recorded rhythmic and melodic sequences that can be used to add impact and variety to your keyboard performances.

Multi Pads are grouped in Banks of four phrases each. The Tyros5 features a variety of Multi Pad Banks in a variety of different musical genres.

Moreover, the Audio Link Multi Pad function allows you to create a new pad with your WAVE (Audio) data to play back during your performance.

## Playing the Multi Pads

### 1 Press the MULTI PAD CONTROL [SELECT] button to call up the Multi Pad Bank Selection display, then select the desired bank.

Select pages using the [1 ▲]–[6 ▲] buttons that correspond to “P1, P2...” in the display or pressing the MULTI PAD CONTROL [SELECT] button repeatedly, then use the [A]–[J] buttons to select the desired bank.

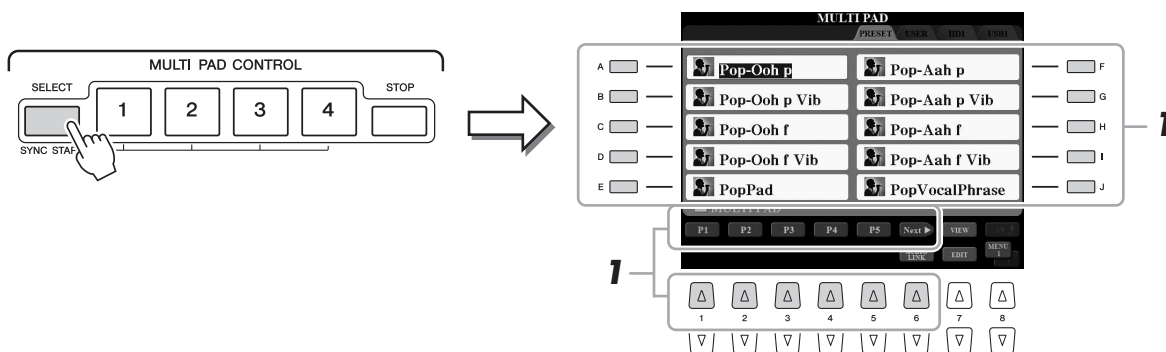

### 2 Press any of the MULTI PAD CONTROL [1]–[4] buttons to play a Multi Pad phrase.

The corresponding phrase (in this case, for Pad 1) starts playing back in its entirety at the currently set tempo. You can play up to four Multi Pads at the same time.

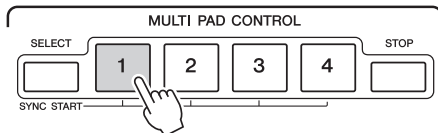

### 3 Press the [STOP] button to stop playback of the Multi Pad(s).

If you want to stop specific pads, simultaneously hold down the [STOP] button and press the pad(s) you wish to stop.

#### About the lamp status of the MULTI PAD CONTROL [1]–[4] buttons

- **Blue:** Indicates that the corresponding pad contains data (phrase).
- **Red:** Indicates that the corresponding pad is playing back.
- **Red (flashing):** Indicates that the corresponding pad is in standby (Synchro Start). Refer to page 65 for using the Synchro Start function.
- **Off:** Indicates the corresponding pad contains no data and cannot be played.

#### NOTE

There are two types of Multi Pad data. Some types will play back once and stop when they reach to the end. Others will play back repeatedly.

#### NOTE

Pressing the pad while it is playing back stops playback and begins playing from the top again.

#### NOTE

- While the Style or MIDI Song is playing back, pressing the MULTI PAD button starts playback at the top of the next bar. While the Style or MIDI Song is stopping, pressing the MULTI PAD button starts playback immediately.
- STYLE CONTROL [START/STOP] button flashes red at the downbeat.

## Using the Multi Pad Synchro Start Function

- 1 While holding the MULTI PAD [SELECT] button, press the desired button or buttons from [1]–[4].

The corresponding buttons flash in red.

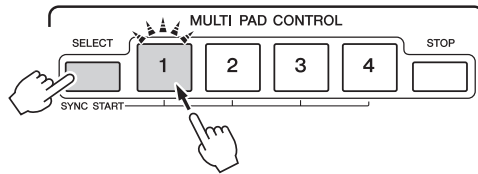

- 2 Start the Style/MIDI Song.

The Multi Pads start at the same time.

If you put the Multi Pad in standby during Style/MIDI Song playback, pressing any note on the keyboard will start Multi Pad playback at the top of the next bar.

### NOTE

To cancel the standby status, press the same button, or press the [STOP] button to cancel the status of all Pads.

## Using Chord Match

When the [ACMP] or Left part is on, play the chord in the Chord section and press any of the Multi Pads. Multi Pad phrases automatically change the pitch to match the chord you play.

### NOTE

Some Multi Pads are not affected by Chord Match.

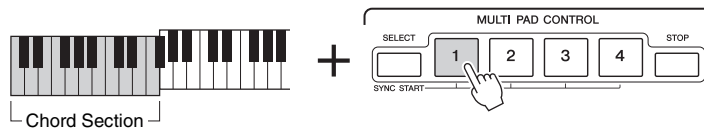

# Creating a New Multi Pad with WAVE files (Audio Link Multi Pad)

You can create a new Multi Pad by making the links with WAVE files in the internal hard disk drive and USB flash memory to each of the Multi Pad. The WAVE files can be the data you've created in the Audio Recorder (page 76) and commercially available ones. Multi Pads to which the WAVE files are linked are called Audio Link Multi Pads. The new Audio Link Multi Pads can be saved in USER, HD and USB drives.

- 1** If you want to use WAVE files in the USB flash memory, connect the USB flash memory containing the data to the [USB TO DEVICE] terminal.

**NOTE**

Before using a USB flash memory, be sure to read "Connecting USB Devices" on page 101.

- 2** Press the MULTI PAD CONTROL [SELECT] button to call up the Multi Pad Bank Selection display.

**NOTE**

You will need to press the [C] (NEW BANK) button in the Audio Link Multi Pad display to create an Audio Pad, if an Audio Link Multi Pad has been selected when you pressed the [6 ▼] (AUDIO LINK) button. Otherwise, you are simply re-selecting the link in the selected Audio Link Multi Pad.

- 3** Press the [6 ▼] (AUDIO LINK) button to call up the Audio Link Multi Pad display.

A confirmation message may appear here. If so, follow the on-display instructions.

**NOTE**

Make sure that MENU 1 is shown at the bottom right corner of the display (page 26).

**NOTE**

A WAVE file cannot be linked to a MIDI Multi Pad.

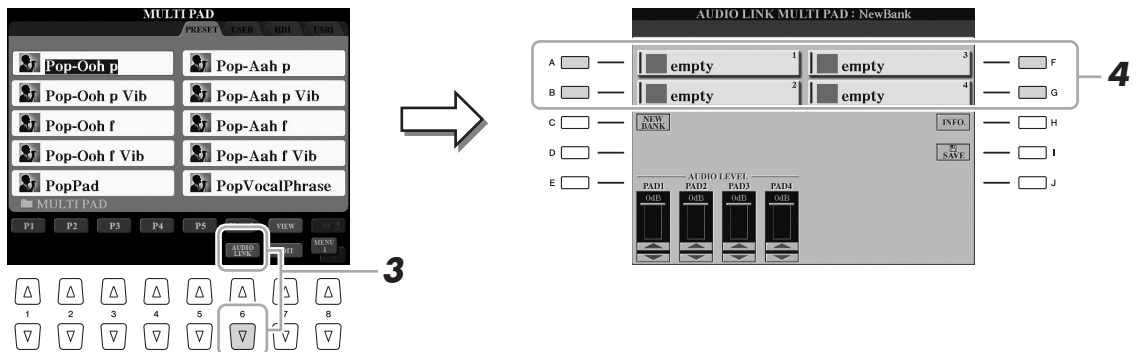

- 4** Select the desired Pad by pressing any of the [A], [B], [F] and [G] buttons.

The WAVE display appears.

- 5** Select the desired WAVE file by using the [A]–[J] buttons.

**To confirm the information of the selected WAVE file**

By pressing the [7 ▲] (INFO.) button, you can confirm the information (title name, bit rate and sample rate, etc.). Press the [F] (OK) button to close it.

- 6** Press the [EXIT] button to return to the Audio Link Multi Pad display.

## 7 If desired, adjust the level of each WAVE file by using the [1 ▲▼]–[4 ▲▼] buttons.

You can adjust the volume while hearing the Multi Pad phrases by pressing the corresponding MULTI PAD CONTROL [1]–[4] buttons.

### To confirm the path of the selected WAVE file

By pressing the [H] (INFO.) button in the Audio Link Multi Pad display, you can confirm the path. Press the [F] (OK) button to close it.

## 8 If you want to link other WAVE files to other pads, repeat steps 4 to 7 above.

## 9 Save the settings as a Multi Pad Bank.

Press the [I] (SAVE) button in the Audio Link Multi Pad display to call up the Multi Pad Bank Selection display to actually execute the Save operation.

After the Save operation is completed, the display automatically returns to the Audio Link Multi Pad display.

## 10 Press the [EXIT] button to check the new Audio Link Multi Pad in the Multi Pad Bank Selection display.

The newly created Audio Link Multi Pad is marked with “Audio Link” at the upper left of the file name.

### If you want to change the Link setting:

Select the desired Audio Link Multi Pad, then execute the same operations as steps 3 to 10.

### **NOTICE**

The setting will be lost if you select another Audio Link Multi Pad or turn the power to the instrument off without executing the Save operation.

3

Multi Pads – Adding Musical Phrases to Your Performance –

## Playing the Audio Link Multi Pads

You can play the Multi Pad to which the WAVE file is assigned by selecting them in the USER, HD or USB drive of the Multi Pad Bank Selection display. Although you can play via the same operations in page 64, note the following limitations.

- Make sure to connect the USB flash memory including the corresponding WAVE files.
- Automatic repeat playback is not available.
- Only one Pad can be played back at once.
- Chord Match cannot be applied.

### **NOTE**

Audio files (WAVE files) take a slightly longer time than MIDI files to load.

### **NOTE**

When the link to the WAVE file is cut (for example, when connecting a USB flash memory which does not include the corresponding WAVE files, etc.), a “Not Found!” is indicated above the Pad name.

### **NOTE**

The lamp is off when the corresponding pad contains no data (phrase).

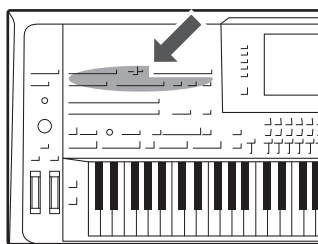

This instrument allows you to record your performance and save it as a MIDI file in SMF format, and play back preset Songs, commercially available MIDI music files, etc. Not only can you play back a song and listen to it, but you can also play the keyboard along with song playback.

**NOTE**

For instructions on the recording and playing back of audio songs (files), refer to page 76.

## Basic Procedure for Recording

Before recording, make the necessary settings such as Voice/Style selection. As necessary, connect the USB flash memory to the [USB TO DEVICE] terminal. With this recording, each part will be recorded to the following channels.

- **Keyboard parts:** channels 1–4
- **Multi Pad parts:** channels 5–8
- **Style parts:** channels 9–16

To record your performance to each channel one by one with specifying the part, refer to page 69.

**NOTE**

Audio data such as the rhythm channels created via the audio data of audio Style (page 52), Audio Link Multi Pad (page 66) and audio songs (page 78) cannot be recorded to the MIDI Songs.

**NOTE**

Before using a USB flash memory, be sure to read “Connecting USB Devices” on page 101.

### 1 Press the SONG [REC] button and the [STOP] button simultaneously.

A blank Song for recording is automatically set.

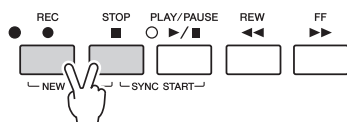

**NOTE**

To cancel the recording, press the [STOP] button before going on step 3.

### 2 Press the SONG [REC] button.

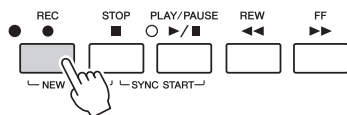

### 3 Start recording.

You can start recording by playing the keyboard, starting Style, starting Multi Pad or pressing the SONG [PLAY/PAUSE] button.

**NOTE**

When recording without Style playback, turning the [METRONOME] on makes your recording sessions much more efficient. The Metronome tempo can be adjusted by TEMPO [-]/[+] buttons.

**NEXT PAGE**



- After you finish performance, press the SONG [STOP] button to stop recording.

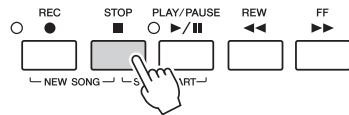

A notice message appears here; press the [EXIT] button to close it.

- Press the SONG [PLAY/PAUSE] button to play back the recorded performance.

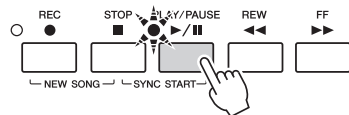

- Save the recorded performance.

**6-1** Press one of the SONG [I]–[IV] buttons to call up the Song Selection display.

**6-2** Save the recorded data as a file by following the instructions on page 29, steps 1–5.

**NOTICE**

The recorded Song will be lost if you change to another Song or you turn the power off without executing the save operation.

**NOTE**

By default, pressing the SONG [I] button calls up the PRESET Page and pressing one of the [II]–[IV] buttons calls up the USER Page.

## Multi Track Recording

You can create a MIDI Song consisting of 16 channels by recording your performance to each channel one by one. In recording a piano piece, for example, you can record the Right-hand part to channel 1 then record the Left-hand part to channel 2, allowing you to create a complete piece which may be difficult to play live with both hands together. To record a performance with Style playback, for example, record the Style playback to channels 9–16, then record melodies to channel 1 while listening to the already recorded Style playback. In this way, you can create an entire Song which would otherwise be difficult, or even impossible, to play live.

- Press the SONG [REC] button and the [STOP] button simultaneously.

A blank Song for recording is automatically set.

**NOTE**

To cancel the recording, press the [STOP] button before going on step 4.

- While holding down the SONG [REC] button, press the [1 ▲▼]–[8 ▲▼] buttons to set the desired channels to “REC.”

To cancel the REC status of the channel, press the same button again.

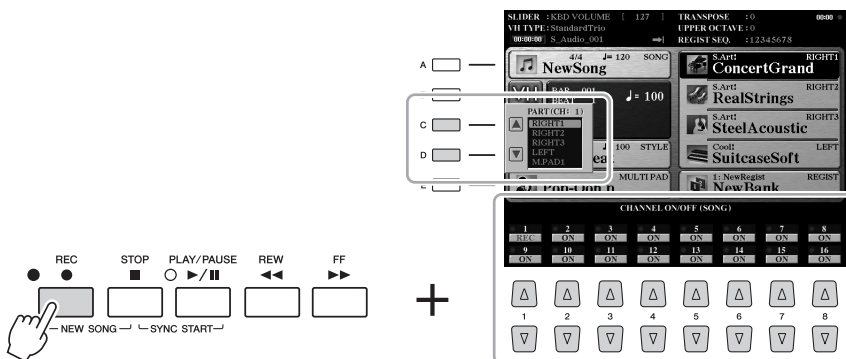

**3 Use the [C]/[D] buttons to assign the desired part for the channel to be recorded.**

To close the window for assigning the part, press the [EXIT] button.

**4 Start recording.**

You can start recording by playing the keyboard, starting Style, starting Multi Pad or pressing the SONG [PLAY/PAUSE] button.



**5 After you finish your performance, press the SONG [STOP] button to stop recording.**

**6 Press the SONG [PLAY/PAUSE] button to play back the recorded performance.**

**7 Record your performance to another channel by repeating steps 2 to 6 above.**

**8 Save the recorded performance.**

**8-1** Press one of the SONG [I]–[IV] buttons to call up the Song Selection display.

**8-2** Save the recorded data as a file by following the instructions on page 29, steps 1–5.

**NOTE**

The use of the [C]/[D] buttons may not be necessary here, since each numbered channel has its own default setting and can be used as is.

**NOTICE**

The recorded Song will be lost if you change to another Song or you turn the power off without executing the Save operation.

# Playback of Songs

You can play back the following types of Songs.

- Preset Songs (in the PRESET Page of the Song Selection display)
- Your own recorded Songs (page 68)
- Commercially available Song data: SMF (Standard MIDI File)

If you want to play back a song in USB flash memory, connect the USB flash memory containing song data to the [USB TO DEVICE] terminal beforehand.

**NOTE**

Before using a USB flash memory, be sure to read “Connecting USB Devices” on page 101.

**1** Press any of the SONG [I]–[IV] buttons to call up the Song Selection display.

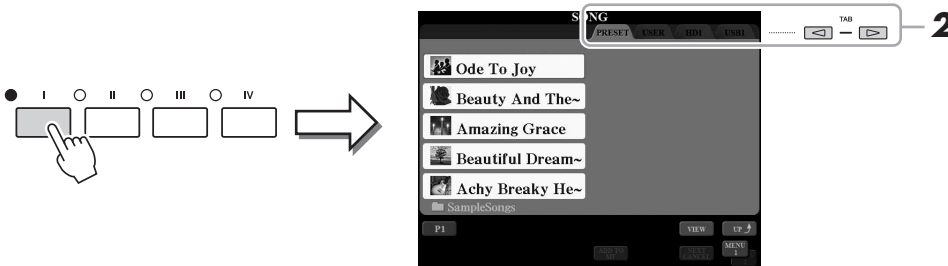

**NOTE**

For information on compatible data formats, refer to page 11.

**NOTE**

The path to the folder of Songs can be memorized, and you can open the folder with a single button-press. For instructions, refer to page 28.

**2** Press the TAB [◀][▶] buttons to select the location of the desired Song.

**3** Select the desired Song by using the [A]–[J] buttons.

You can also select a Song by using the [DATA ENTRY] dial, then press the [ENTER] button to execute.

**NOTE**

You can instantly jump back to the Main display by “double-clicking” on one of the [A]–[J] buttons.

**4** Press the SONG [PLAY/PAUSE] button to start playback.

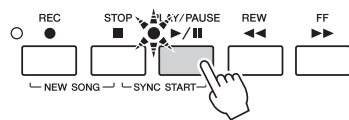

**NOTE**

You can play multiple Songs repeatedly: [FUNCTION] → [B] SONG SETTING → [H] REPEAT FOLDER. For details, refer to the Reference Manual on the website.

### Queuing the next Song for playback

While a Song is playing back, you can queue up the next Song for playback. This is convenient for chaining it to the next Song smoothly during stage performance. Select the Song you want play next in the Song Selection display, while a Song is playing back. The “NEXT” indication appears at the upper right of the corresponding Song name. To cancel this setting, press the [7 ▼] (NEXT CANCEL) button.

**5** Press the SONG [STOP] button to stop playback.

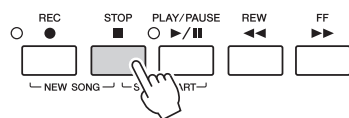

# Operations During Playback

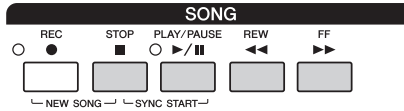

- Synchro Start** ..... You can start playback as soon as you start playing the keyboard. While playback is stopped, hold down the SONG [STOP] button and press the [PLAY/PAUSE] button. To cancel the Synchro Start function, hold down the SONG [STOP] button and press the [PLAY/PAUSE] button once again.
- Pause** ..... Press the [PLAY/PAUSE] button during playback. Pressing it again resumes Song playback from the current position.
- Rewind/Fast Forward** ..... Press the [REW] or [FF] button once to move back/forward one measure. Hold the [REW] or [FF] button to scroll backward/forward continuously.

Pressing the [REW] or [FF] button calls up a pop-up window showing the current measure number (or Phrase Mark number) in the display. While the Song Position pop-up is shown on the display, you can also use the [DATA ENTRY] dial to adjust the value.

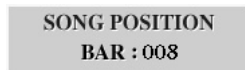

For Songs not containing Phrase Marks



For Songs containing Phrase Marks  
You can switch between BAR and PHRASE MARK by pressing the [E] button.

**NOTE**

You can have Song playback fade in/out or change the tempo (page 54).

**NOTE**

You can adjust the Song volume balance between the Song and keyboard (page 61). On the VOL/VOICE page of the MIXING CONSOLE display (page 93), you can adjust the volume for each Song part.

**NOTE**

You also can adjust the volume balance between the MIDI Song and Audio Song (page 61).

**NOTE**

You can also turn the specific part(s) on or off. See page 75.

**NOTE**

Phrase Mark is a pre-programmed marker in a certain Song data, which specifies a certain location in the Song.

**NOTE**

You can transpose Song playback (page 46).

## Displaying Music Notation (Score)

You can view the music notation (score) of the selected Song.

**1** Select a Song (steps 1–3 on page 71).

**2** Press the [SCORE] button to call up the SCORE display.

You can look through the entire notation by using the TAB [◀][▶] buttons when the Song playback is stopped. As starting playback, the “ball” bounces along through the score, indicating the current position.

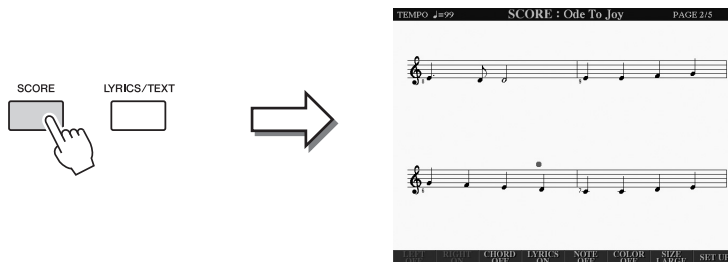

You can change the displayed notation style by using the [1 ▲▼]–[8 ▲▼] buttons. For details on the SCORE display, refer to the Reference manual on the website.

### NOTE

This instrument can display the music notation of your recorded MIDI Song, or commercially available MIDI file (only the one which allows any device to indicate the score).

### NOTE

The displayed notation is generated by the Tyros5 based on the Song data. As a result, it may not be exactly the same as commercially available sheet music of the same Song—especially when displaying notation of complicated passages or many short notes.

## Displaying Lyrics (Text)

When the selected Song contains lyrics data, you can view it on the Tyros5 display during playback. Even if the Song doesn't contain lyrics data, you can view the lyrics on the display by loading the text file (.txt) created on a computer via USB flash memory. Text display allows for a variety of useful and convenient possibilities, such as the showing of lyrics, chord charts, and performance notes.

**1** Select a Song (steps 1–3 on page 71).

**2** Press the [LYRICS/TEXT] button to call up the LYRICS display.

When the Song data contains lyrics data, the lyrics are shown on the display. You can look through the entire lyrics by using the TAB [◀][▶] buttons when the Song playback is stopped. As Song playback starts, the color of the lyrics changes, indicating the current position.

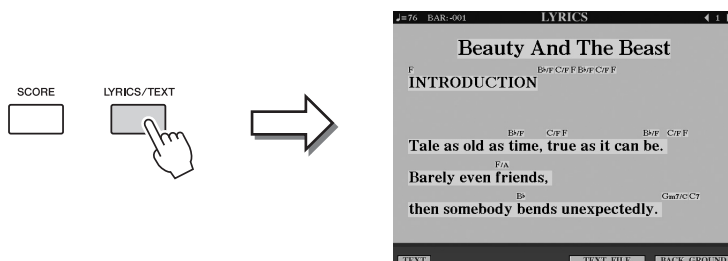

When you want to view the text file created on your computer, press the [5 ▲▼]/ [6 ▲▼] (TEXT FILE) button to select the desired text file, then press the [1 ▲▼] (TEXT) button to display the selected file.

For more information about the LYRICS display, refer to the Reference manual on the website.

### NOTE

The Lyrics (text) can be displayed on an external monitor (page 99).

## Using Song Position Markers

Song Position markers (SP 1–SP 4) can be placed in the Song data. This not only lets you navigate quickly and easily through the Song data, but also lets you set up convenient playback loops—allowing you to create dynamic Song arrangements “on the fly,” as you perform.

### Entering Song Position Markers

- 1** Select a Song and start playing back (page 71).
- 2** When the Song reaches the point you wish to enter a marker, double-click (press twice quickly) one of the [SP 1]–[SP 4] buttons during playback.

The corresponding button flashes in green, and the marker for that button is entered to the 1st beat of the appropriate measure.

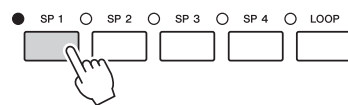

Continue to enter other markers in the same way.

- 3** Stop Song playback by pressing the [STOP] button.
- 4** Save the Song (page 69).

#### About the lamp status of the SP buttons

- **Red:** The Song Position has been passed and song playback continues to the next Song Position.
- **Green:** Song Position is entered to the button.
- **Off:** Song Position is not entered to the button.

#### NOTE

Entering the marker to the lit button (red or green) will set the marker to a new song position.

#### NOTE

You can also enter the marker when the Song playback is paused at the desired position, by double-clicking any of the [SP 1]–[SP 4] buttons. The marker is entered at the top of the current measure.

#### **NOTICE**

The entered marker settings will be lost if you change to another Song or you turn the power off without executing the save operation.

### Jumping to a Marker During Playback

Simply pressing the one of the [SP 1]–[SP 4] buttons during song playback jumps to the corresponding position, after the current played measure reaches its end. (The button will flash in red, indicating that playback jump is ready.) You can cancel the jump by pressing the same SP button again before the actual jump.

### Starting Playback from a Specific Marker

First press the desired SP button (while Song playback is stopped), then press the [PLAY/PAUSE] button.

## Using Markers in Loop Playback

In this section, we'll explain loop playback by the example of looping between markers SP 1 and SP 2.

**1** Press the [PLAY/PAUSE] button to start playback from the top of the Song.

**2** After passing the [SP 1] point, press the [LOOP] button to turn the loop function on.

The Song plays back up to the [SP 2] point, then goes back to [SP 1] and loops between the two points.

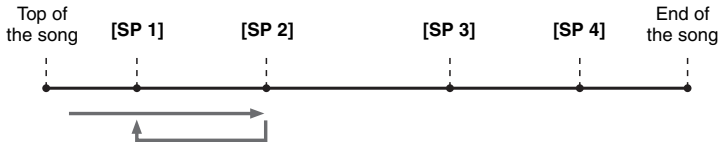

**3** To turn the loop function off, press the [LOOP] button again.

When you turn it off, playback continues past the [SP 2] point.

## Turning Each Channel of the Song On/Off

**1** Press the [CHANNEL ON/OFF] button a few times to call up the CHANNEL ON/OFF (SONG) display.

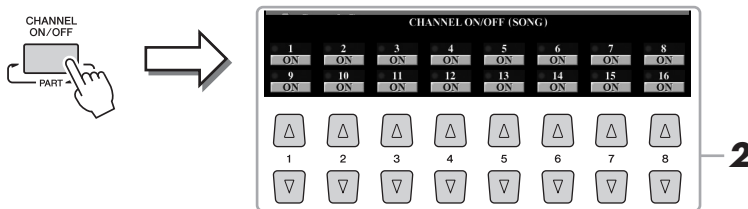

**2** Use the [1 ▲▼]–[8 ▲▼] button to turn each channel on or off.

If you want to play back only one particular channel (solo playback), press and hold down one of the [1 ▲▼]–[8 ▲▼] buttons corresponding to the desired channel. Only the selected channel is turned to on and others are off. To cancel solo playback, press the same button again.

**3** Press the [EXIT] button to close the CHANNEL ON/OFF display.

### NOTE

The Voice for each channel can be changed from the VOL/VOICE page of the MIXING CONSOLE display (page 93).

# 5

# Audio Recorder/Player

– Recording and Playing Audio Files –

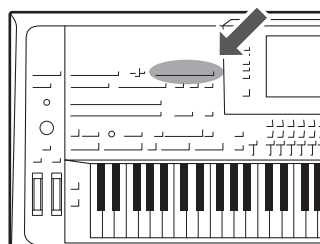

This instrument lets you record your performances as audio data to internal hard disk drive.

### Sounds that can be recorded:

- Sounds that are generated via all the keyboard parts (Left, Right 1–3), Song parts, Style parts, and Multi Pad parts.
- Sounds of the portable audio player that are input via the [AUX IN] jack.
- Sounds that are input via the [MIC INPUT] jack, such as a microphone.

### Maximum amount of recording time:

- 80 minutes per recording

### The recorded data using this function is saved as:

- WAV - 44.1 kHz sample rate, 16 bit resolution, stereo

## Recording Your Performance as Audio

**1** Make the necessary settings such as Voice/Style selection and the microphone connection (if you want to record your vocal).

**2** Press the AUDIO RECORDER/PLAYER [REC] button.

The REC lamp flashes, and the AUDIO RECORDER/PLAYER display appears. This operation will create a new empty audio file named “S\_Audio\_\*\*\*.WAV.”

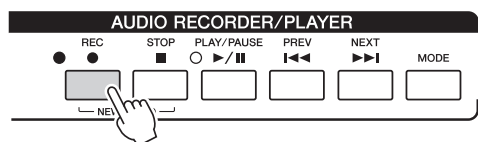

**3** Before recording, check the recording levels on the REC MONITOR meter by playing the keyboard, Style, etc., and adjust them accordingly by using the [1 ▲▼] buttons or sliders.

Adjust the control so that the volume doesn't constantly go into the “red” and light up the indicator.

### NOTE

Press the 1's [▲] and [▼] buttons simultaneously to instantly reset the recording volume to 90.



▶ NEXT PAGE



#### 4 Press the [PLAY/PAUSE] button to start recording.

Immediately after this operation, start and record your performance.

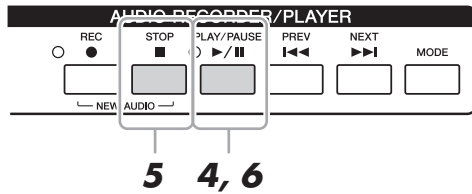

#### 5 When your performance is finished, press the [STOP] button to stop recording.

Recorded data is automatically saved to internal hard disk drive (HD) as a file with the name automatically set.

#### 6 To hear your new recording, press the [PLAY/PAUSE] button.

To see the file of the recorded performance in the Audio File Selection display, press the [A] (FILE) button.

#### 7 Press the [EXIT] button to exit from the AUDIO RECORDER/PLAYER display.

##### NOTE

You can record additional performances to the existing Audio file by using the Multi Track Recording method. For details, refer to the Reference Manual.

# Playing Back Audio Files

You can play back the following file formats on this instrument.

- **WAV** .....44.1 kHz sample rate, 16 bit resolution, stereo
- **MP3** .....MPEG-1 Audio Layer-3: 44.1/48.0 kHz sample rate, 64–320 kbps and variable bit rate, mono/stereo

If you want to play back an Audio file in USB flash memory, connect the USB flash memory containing the file to the [USB TO DEVICE] terminal beforehand.

**NOTE**

- DRM (Digital Rights Management) protected Audio files cannot be played back.
- The Audio files take a slightly longer time to load than other files.

**NOTE**

Before using a USB flash memory, be sure to read "Connecting USB Devices" on page 101.

**1 Press the AUDIO RECORDER/PLAYER [MODE] button to call up the AUDIO RECORDER/PLAYER display.**

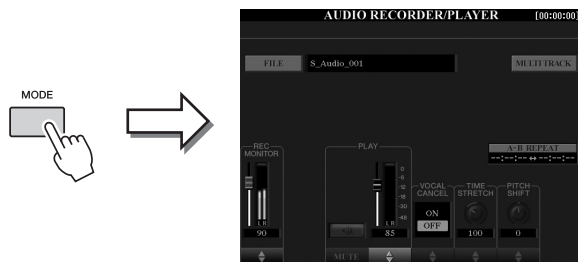

**2 Press the [A] (FILE) button to call up the Audio File Selection display.**

**3 Select the file you want to play back.**

Use the TAB [◀][▶] buttons to select the location (HD or USB) where the desired file is, then press one of the [A]–[J] buttons corresponding to the file.



**Viewing Audio file information**

Pressing the [7 ▲] (INFO) button calls up the Information window which you can view the file name, path, sample rate etc. of the selected red-framed file. To close the window, press the [F] (OK) button.

**4 Press the [PLAY/PAUSE] button to start playback.**



**5 If you want to make playback-related settings or operations (page 79), press the [EXIT] button to return to the AUDIO RECORDER/PLAYER display.**

**6 To stop playback, press the [STOP] button.**

# Playback-related Operations

## Operations on the panel

### ● Selecting the previous/next Audio Song ([PREV] or [NEXT] button)

Press the [PREV] or [NEXT] button to select the previous/next Audio file in the same folder. Hold one of them to move backward/forward continuously through the current file (in seconds).

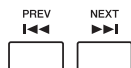

Pressing the [PREV] or [NEXT] button calls up the Audio Position pop-up window showing the current position of the Audio file. When the window is shown on the display, you can also use the [DATA ENTRY] dial to move backward/forward continuously through the current file.



### ● Adjusting the volume balance between the MIDI Song and Audio file

#### Cross Fader

Lets you adjust the volume balance between MIDI Song playback and Audio file playback. Moving the fader leftward increases the volume of MIDI Song playback, and moving rightward increases the volume of Audio playback.

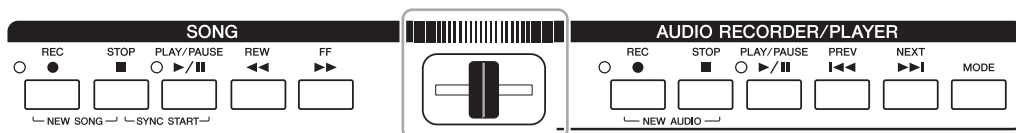

#### [BALANCE] button

Pressing the [BALANCE] button once or twice calls up the BALANCE (2/2) display (page 61). In this display, you can adjust the volume balance between the MIDI Song and Audio file by using the [2 ▲▼]–[3 ▲▼] buttons. When this is set to CENTER, the levels of the MIDI Song and Audio file are equal. To instantly reset the balance to CENTER, press the [2 ▲▼] and [3 ▲▼] buttons simultaneously.



#### NOTE

Immediately after the power is turned on, the volume balance between the MIDI Song playback and Audio file playback is located at the center position regardless of the Cross Fader position. The volume balance can be adjusted via both the Cross Fader and [2 ▲▼]–[3 ▲▼] buttons in the BALANCE (2/2) display. In either case, the actual volume balance is shown in the BALANCE (2/2) display.

## Operations on the display

---



### ● A-B Repeat Playback (the [I] button)

The specified range (between the A and B points) can be played back repeatedly.

- 1 To set the A point, press the [I] button when playback reaches to the desired point.**

The time set as the A point is shown in at “A [--:--:--]” in the display.

- 2 To set the B point, press the [I] button again when playback reaches to the desired point.**

The time set as the B point is shown in at “B [--:--:--]” in the display.

The specified A-B range of the Audio file will now play back repeatedly.

- 3 To cancel Repeat playback, press the [I] button again.**

### ● Vocal Cancel ([5 ▲▼] buttons)

This lets you cancel or attenuate the center position of the stereo sound. This lets you sing “karaoke” style with just instrumental backing, since the vocal sound is usually at the center of the stereo image in most recordings.

### ● Time Stretch ([6 ▲▼] slider or buttons)

This lets you adjust the playback speed of an Audio file by stretching or compressing it. Higher values result in a faster tempo.

### ● Pitch Shift ([7 ▲▼] slider or buttons)

This lets you shift the pitch of an Audio file in semitone steps.

### ● Audio Volume ([4 ▲▼] slider or buttons)

This lets you adjust the playback volume of an Audio file.

### ● Mute ([3 ▲▼] buttons)

This lets you mute the sound of an Audio file.

#### **NOTE**

- The value can be adjusted from 70% to 160%.
- Time Stretch cannot be applied to MP3 files of 48.0 kHz sample rate.

#### **NOTE**

Pitch Shift cannot be applied to MP3 files of 48.0 kHz sample rate.

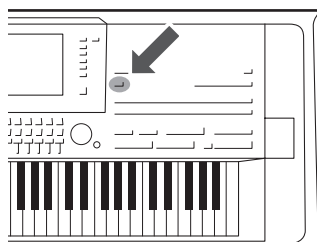

This feature lets you call up panel settings ideal for your performance simply by selecting a Music Finder “Record,” which includes Voice and Style settings. If you want to play a certain piece of music but don’t know which Style and Voice settings would be appropriate, you can search for relevant Records by the title of the piece.

Moreover, by registering MIDI Song, Audio Song and Style files saved in various locations into Music Finder, you can easily call up the desired file from the corresponding Record.

### Downloading Records (panel settings) from the website

As a factory default, some sample Records are provided in the Music Finder. To use the Music Finder function more conveniently and effectively, we recommend that you download the Records from the Yamaha website, and load them to this instrument.

- 1 On the computer, access the following website and download the Music Finder file (\*.mfd) to the USB flash memory connected to the computer.  
<http://download.yamaha.com/>
- 2 Connect the USB flash memory which contains the Music Finder file (\*.mfd) to the [USB TO DEVICE] terminal of the instrument.
- 3 Press the [MUSIC FINDER] button to call up the MUSIC FINDER display.

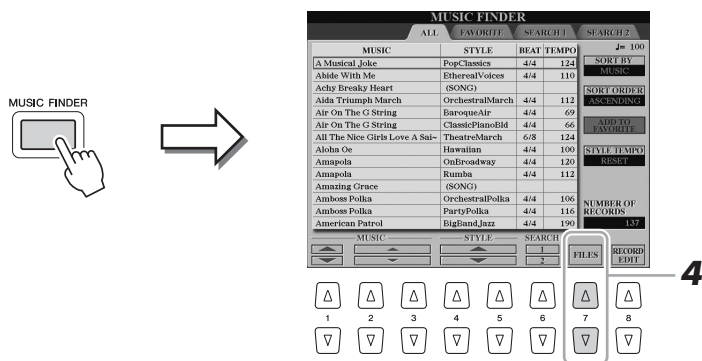

- 4 Press the [7 ▲▼] (FILES) button to call up the File Selection display.
- 5 Select the Music Finder file in the USB flash memory by pressing the [A]–[J] buttons to call up a message prompting you to select REPLACE or APPEND.
- 6 Press the [G] (APPEND) button if you want to add Records of the selected Music Finder file, or press the [F] (REPLACE) button if you want to replace all Records with the new ones.
- 7 Press the [G] (YES) button in response to the confirmation message.
- 8 Press the [F] (YES) button to complete of the operation.  
By checking the number of Records in the right lower corner of the display, you can confirm the Records have been appended.

### NOTE

Before using a USB flash memory, be sure to read “Connecting USB Devices” on page 101.

### NOTE

Even after appending or replacing the Music Finder Records, you can restore them to their original factory settings by selecting the “MusicFinderPreset” file in PRESET display of the step.

## Selecting the Desired Record (Panel Settings)

- 1 Press the [MUSIC FINDER] button to call up the MUSIC FINDER display.

Each entry is called a "Record." This shows the song titles (MUSIC) and information of the Styles included.



MUSIC	STYLE	BEAT	TEMPO
A Musical Joke	PopClassics	4/4	124
Abide With Me	Ethereal/Voices	4/4	110
Acha Erenky Heart	(SONG)		
Aida Triumph March	OrchestralMarch	4/4	112
Air On The G String	BaroqueAir	4/4	69
Air On The G String	ClassicPianoBd	4/4	66
All The Nice Girls Love A Sal-	TheatreMarch	6/8	124
Aloha Oe	Hawaiian	4/4	100
Amapola	OnBroadway	4/4	120
Amapola	Rumba	4/4	112
Amazing Grace	(SONG)		
Amboos Polka	OrchestralPolka	4/4	106
Amboos Polka	PartyPolka	4/4	116
American Patrol	BigBandJazz	4/4	190

- 2 Use the [2 ▲▼]/[3 ▲▼] buttons to select the desired Record.

You can also use the [DATA ENTRY] dial and the [ENTER] button.

The panel settings in the Record are called up. When the Record including the Style name is selected, the [ACMP] and [SYNC START] buttons are turned on and the corresponding Style is called up. This lets you start Style playback immediately.

### Sorting the Records

Press the [F] (SORT BY) button repeatedly if necessary to change how the Records are sorted: by MUSIC (music piece), STYLE, BEAT or TEMPO. Press the [G] (SORT ORDER) button to alternate the order, ascending or descending.

When sorting the Records by MUSIC, you can use the [1 ▲▼] button to skip up or down through the Song names alphabetically. When sorting the Records by STYLE, you can use the [4 ▲▼]/[5 ▲▼] button to skip up or down through the Style names alphabetically.

Simultaneously press the [▲] and [▼] buttons to move the cursor to the first Record.

- 3 Play the Style by specifying the chords with your left hand and play the melody with your right.

### To avoid changing the tempo during Style playback when selecting another Record

Press the [I] (STYLE TEMPO) button to set the "STYLE TEMPO" to "HOLD" or "LOCK." When set to "LOCK," the tempo will be locked while stopping as well as playing. If you want to reset the tempo every time you select another Record, set to "RESET."

# Searching for Records (Panel Settings)

You can search the Records by specifying a song title or keyword, using the Search function of the Music Finder.

- 1** In the MUSIC FINDER display, press the [6 ▲] (SEARCH 1) button to call up the SEARCH 1 display.

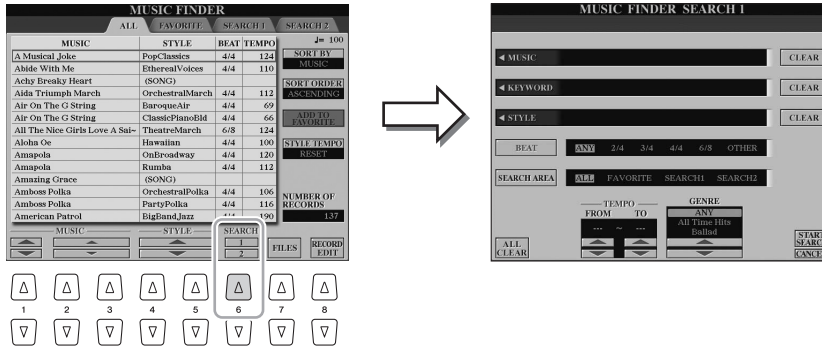

## 2 Enter the search criteria.

[A]	MUSIC	Calls up the Character Entry window (page 34) to enter the song title. To clear the entered title, press the [F] (CLEAR) button.
[B]	KEYWORD	Calls up the Character Entry window (page 34) to enter the keyword. To clear the entered keyword, press the [G] (CLEAR) button.
[C]	STYLE	Calls up the Style Selection display (page 51). After selecting the Style by the [A]–[J] buttons, press the [EXIT] button to return to the SEARCH 1 display. To clear the entered Style name, press the [H] (CLEAR) button.
[D]	BEAT	Specifies the time signature. All beat settings are included in the search if you select ANY.
[E]	SEARCH AREA	Selects a specific location (the tab of the upper part of the MUSIC FINDER display).
[1 ▲▼]	ALL CLEAR	Clears all entered search criteria.
[3 ▲▼]	TEMPO FROM	Sets the range of the tempo you want to use for the search.
[4 ▲▼]	TEMPO TO	
[5 ▲▼]/ [6 ▲▼]	GENRE	Selects the desired music genre.

## 3 Press the [8 ▲] (START SEARCH) button to start the search.

After the Search is completed, the resulting Records appear in the SEARCH 1 page. If no Records are listed, try the steps 2–3 again with another song title or keyword.

## 4 Use the [2 ▲▼]/[3 ▲▼] buttons to select the desired Record.

## 5 Play the Style by specifying the chords with your left hand and playing the melody with your right.

### NOTE

To cancel searching, press the [8 ▼] (CANCEL) button.

### NOTE

If you want to input two or more keywords, insert a comma between each word.

### NOTE

If you select a beat of 2/4 or 6/8, a Style suitable for performing a song in 2/4 and 6/8 beat can be searched, but the actual Style is created by using a 4/4 beat.

### NOTE

If you want to maintain the current Record search results and start another search, use the [6 ▼] (SEARCH 2) button. (The current search Records will remain in the in the SEARCH 1 page.)

## Registering a MIDI Song, Audio Song or Style to a Record

By registering MIDI Song, Audio Song or Style files in various locations (PRESET, USER, HD and USB) into Music Finder, you can easily call up your favorite files.

- 1** In the Song, Audio or Style Selection display, select the desired file.



- 2** MIDI Song/Style  
Press the [5 ▼] (ADD TO MF) button to get ready to register the selected file to Music Finder.

Audio Song

- 2** Press the [5 ▲] (ADD TO MF) button to get ready to register the selected file to Music Finder.

The display automatically changes to the MUSIC FINDER RECORD EDIT display. If desired, you can change the music title and keyword, etc. For details about editing the Records, refer to the Reference manual on the website.

- 3** Press [8 ▲] (OK) button to actually register the file.

- 4** Check that the registered Record is shown in the MUSIC FINDER display.

In the STYLE column of the Record, the MIDI Song is registered as “(SONG)”, the Audio Song is as “(AUDIO)” and Style is registered its Style name.

### NOTE

- If you want to register files in the USB flash memory, connect the USB flash memory containing the data to the [USB TO DEVICE] terminal.
- Before using a USB flash memory, be sure to read “Connecting USB Devices” on page 101.

### NOTE

Make sure that MENU 1 is shown at the bottom right corner of the display (page 26).

### NOTE

Multi Track recording files (.aud) cannot be registered into Music Finder. For information on the Multi Track recording, refer to the Reference Manual on the website.

### NOTE

To cancel the operation, press the [8 ▼] (CANCEL) button.

## Calling up the MIDI Song, Audio Song or Style registered to Music Finder

You can call up the registered MIDI Song, Audio Song or Style in the same way as done in the sections “Selecting the Desired Record” (page 82) and “Searching for Records” (page 83).

- To play back the selected MIDI Song, press the SONG [PLAY/PAUSE] button.
- To play back the selected Audio Song, press the AUDIO RECORDER/PLAYER [PLAY/PAUSE] button.
- To play back Style, specify the chords with your left hand and play the melody with your right.

### NOTE

If you register a MIDI Song, Audio Song or Style in the USB flash memory to a Record, make sure to connect the same USB flash memory to the [USB TO DEVICE] terminal when you call it up via the Music Finder Record.



# 7

# Registration Memory

– Saving and Recalling Custom Panel Setups –

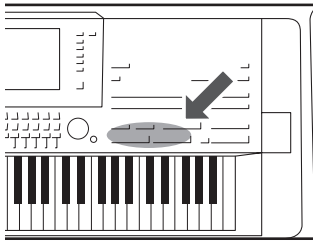

The Registration Memory function allows you to save (or “register”) virtually all panel settings to a Registration Memory button, and then instantly recall your custom panel settings by simply pressing a single button. The registered settings for eight Registration Memory buttons should be saved as a single Bank (file).

## Registering Your Panel Setups

### 1 Set up the panel controls (such as Voice, Style, effects, and so on) as desired.

Refer to the Registration section of the “Parameter Chart” in the Data List (page 10) for information on the parameters that can be registered with the Registration Memory function.

### 2 Press the [MEMORY] button in the REGISTRATION MEMORY section.

The display for selecting the groups to be registered appears.

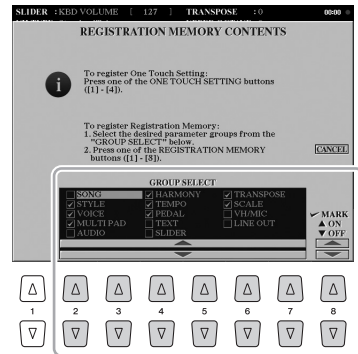
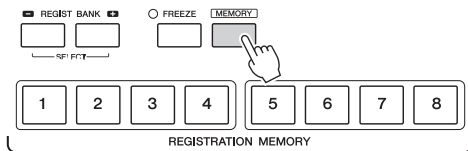

### 3 Determine the groups you want to register.

Select the desired groups by using the [2 ▲▼]–[7 ▲▼] buttons, then enter or remove the checkmark by using the [8 ▲] (MARK ON)/[8 ▼] (MARK OFF) buttons. Groups having checkmarks will be registered. To cancel the operation, press the [I] (CANCEL) button.

▶ NEXT PAGE

- 4** Press one of the REGISTRATION MEMORY [1]–[8] buttons to which you wish to memorize the panel setup.

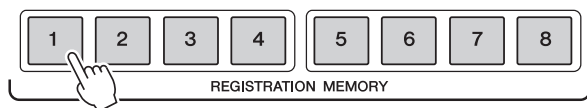

The memorized button becomes red, which indicates the number button contains data and its number is selected.

#### About the lamp status

- **Red:** Data registered and currently selected
- **Blue:** Data registered but not currently selected
- **Off:** No data registered

- 5** Register various panel setups to other buttons by repeating steps 1–4.

The registered panel setups can be recalled by simply pressing the desired number button.

#### NOTICE

If you select the button whose lamp is lit in red or blue here, the panel setup previously memorized to the button will be erased and replaced by the new settings.

#### NOTE

- The panel setups registered in the numbered buttons are preserved even when you turn off the power. If you want to delete all eight current panel setups, turn the power switch on while holding the second right-most key (Tyros5-76: F#6, Tyros5-61: B5) on the keyboard.
- You can also disable recall of specific group(s) when calling up the registered panel setups: [FUNCTION] → [E] REGIST SEQUENCE/FREEZE/VOICE SET → TAB [◀][▶] FREEZE.

## Saving the Registration Memory as a Bank file

You can save all eight registered panel setups as a single Registration Memory Bank file.

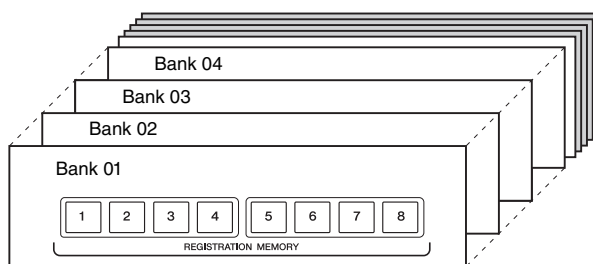

- 1** Press the REGIST BANK [+] and [-] buttons simultaneously to call up the Registration Bank Selection Display.

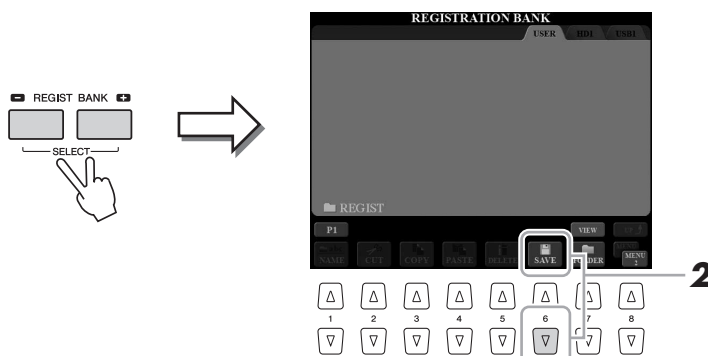

- 2** Press the [6 ▼] (SAVE) button to save the Bank file.

For instructions on saving, refer to page 29.

#### NOTE

Make sure that MENU 2 is shown at the bottom right corner of the display (page 26).

## Recalling a Registered Panel Setup

The saved Registration Memory Bank files can be recalled by using the REGIST BANK [-]/[+] buttons, or by using the following procedure.

- 1 Press the REGIST BANK [+] and [-] buttons simultaneously to call up the REGISTRATION BANK Selection Display.**
- 2 Press one of the [A]–[J] buttons to select a Bank.**  
You can also use the [DATA ENTRY] dial and the [ENTER] button to select a Bank.
- 3 Press one of the blue-lit numbered buttons ([1]–[8]) in the Registration Memory section.**

### NOTE

- When recalling the setups including Song, Style or text file selection from a USB storage device, make sure that the appropriate USB storage device including the registered Song, Style or text is connected into the [USB TO DEVICE] terminal.
- Before using a USB flash memory, be sure to read "Connecting USB Devices" on page 101.

## Confirming the Registration Memory Information

You can call up the information display to take a look which Voices and Style are memorized to the [1]–[8] buttons of a Registration Memory Bank.

- 1 Simultaneously press the REGIST BANK [+] and [-] buttons to call up the Registration Bank Selection display, then use the [A]–[J] buttons to select the desired Bank.**  
You can also use the [DATA ENTRY] dial and the [ENTER] button to select a Bank.

### NOTE

You can instantly call up the information display of the currently selected Registration Memory Bank by pressing the [DIRECT ACCESS] button and one of the REGISTRATION MEMORY [1]–[8] buttons in sequence.

- 2 Press the [6 ▼] (INFO) button to call up the information display.**

### NOTE

Make sure that MENU 1 is shown at the bottom right corner of the display (page 26).

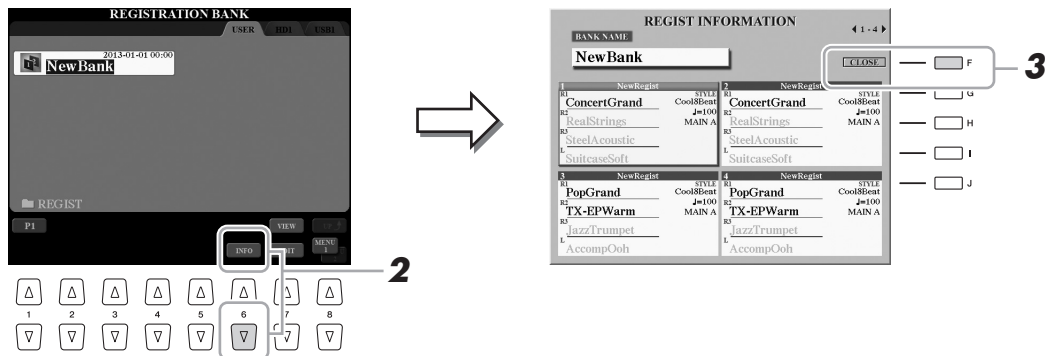

By using the TAB [◀][▶] buttons, you can switch between the two information display pages: information for the Registration Memory [1]–[4] buttons and information for the [5]–[8] buttons.

- 3 Press the [F] (CLOSE) button to close the information display.**

### NOTE

If a certain Voice part is set to off, the Voice name for the corresponding part is shown in gray.

# 8

# Microphone

– Adding Harmony Vocals and Synth Vocoder to Your Singing –

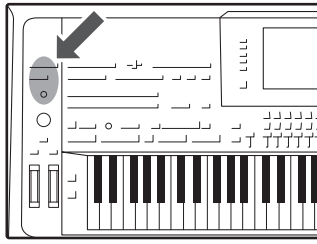

By connecting a microphone to the [MIC INPUT] jack (accepts either XLR or standard 1/4" phone plug connectors), you can enjoy singing along with your keyboard performance or with Song playback. The instrument outputs your vocals through the connected speaker system (page 15). Moreover, you can automatically apply various Vocal Harmony effects to your voice as you sing, or you can use Synth Vocoder to graft the unique characteristics of your voice onto synthesizer and other sounds.

## Connecting a Microphone

- 1 Before turning on the power of the instrument, set the [MIC GAIN] knob to the minimum position.

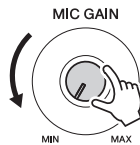

**NOTE**

A dynamic microphone with an impedance of 250 ohms is recommended.

- 2 Connect a microphone to the [MIC INPUT] jack.

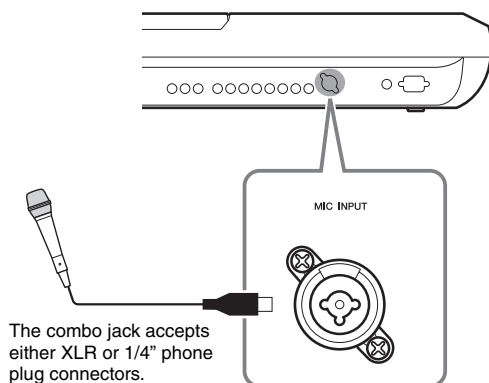

- 3 Turn on the power of the instrument.
- 4 (If necessary, turn on the microphone.) Adjust the [MIC GAIN] knob while singing into the microphone.

Adjust the [MIC GAIN] knob so that the INPUT LEVEL meter lights in green or yellow on the MIC SETTING display (called up by pressing the [MIC SETTING] button). Make sure that the meter does not light in orange or red, since this indicates that the input level is too high.

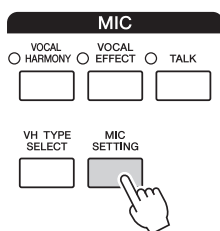

**NEXT PAGE**

## 5 Adjust the volume balance between the microphone sound and the instrument sound on the BALANCE display (page 61).

### Disconnecting the microphone

- 1 Set the [MIC GAIN] knob to the minimum position.
- 2 Disconnect the microphone from the [MIC INPUT] jack.

## Using Vocal Harmony

This section covers the Vocal Harmony Effects that can be applied to your voice via the microphone sound.

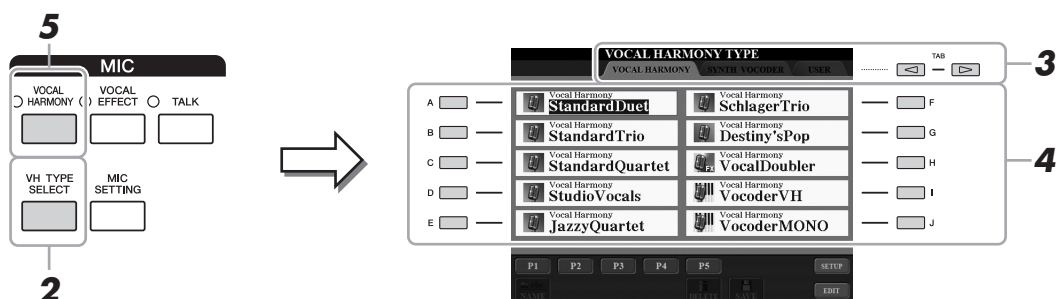

- 1 Connect the microphone to the instrument (page 88).
- 2 Press the [VH TYPE SELECT] button to call up the Vocal Harmony Type Selection display.



- 3 Use the TAB [◀][▶] buttons to select the VOCAL HARMONY tab.

- 4 Use the [A]–[J] buttons to select the desired Vocal Harmony type.

The Vocal Harmony features three different Modes which can be selected automatically by selecting a Vocal Harmony type.

Icon	Mode	Descriptions
 (Microphone)	Chordal	The harmony notes are determined by the chords you play in the chord section (with [ACMP] turned on), the left hand section (with [ACMP] turned off and [LEFT] turned on) or the chord data of a Song.
 (Microphone with FX)	Chordal	The harmony notes are determined in the same way as in Microphone above. However, effects such as Vocal Doubler and Short Delay are applied. Harmony may or may not be applied depending on the selected type. (If harmony is not applied, the [VOCAL HARMONY] button is not lit.)
 (Microphone and keyboard)	Vocoder	The microphone sound is output via the notes you play on the keyboard or via the Song playback notes.
	Vocoder-Mono	Same as the Vocoder basically. In this mode, only single-note melodies or lines can be played back (with last-note priority).

- 5 If necessary, press the [VOCAL HARMONY] button to turn the function on.

## 6 Follow the steps below, depending on which Type (and mode) you selected.

### If you selected one of the Chordal Types:

**6-1** Turn the [ACMP] button on.



**6-2** Play chords with your left hand, or play back the Song which contains chord data.  
Vocal harmonies based on the chords are applied to your singing.

#### NOTE

If you selected a Type having an “FX” icon, your voice will be processed with effects, but may not have harmonies applied.

### If you selected one of the Vocoder or Vocoder-Mono Types:

**6-1** Call up the SETUP window in the display by pressing the [8 ▲] button.

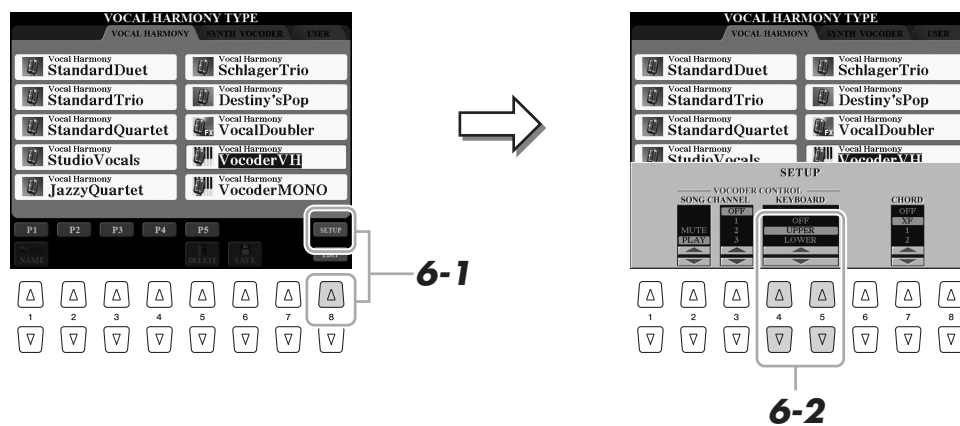

**6-2** Use the [4 ▲▼]/[5 ▲▼] buttons to change the Keyboard setting (OFF, UPPER, LOWER), if necessary.  
When UPPER or LOWER is selected, playing the right-hand or left-hand section of the keyboard will control the Vocoder effect. When OFF is selected, playing the keyboard will not control the Vocoder effect. For more information on the Keyboard setting to control the Vocoder effect, refer to the Reference manual on the website.

**6-3** Play melodies on the keyboard or play back a Song, and sing into the microphone.  
You’ll notice that you don’t actually have to sing pitched notes. Your vocal sound (words, consonants, vowels, etc.) is grafted onto the notes or single lines you play on the keyboard or the notes of Song playback.

#### NOTE

For VOCODER Types, the effect is applied to a maximum of three notes of the chord you play; for Vocoder-Mono, the effect is only applied to single notes (last note played).

## Using the Talk Function

Turning the Talk function on by pressing the [TALK] button lets you instantly change the microphone settings for talking. This is useful when you want to make announcements between song performances.

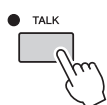

You can also adjust the Talk settings to suit your preferences. For details, refer to the Reference Manual on the website.

# Using Synth Vocoder

These are special effects that graft the characteristics of your voice onto synthesizer and other sounds, for unusual machine-like or robotic effects, as well as unique choir sounds, which you can control with your own singing and playing.

The defining icon (Microphone and carrier) is indicated to the left of each Synth Vocoder.



- 1** Execute steps 1–2 in “Using Vocal Harmony” on page 89.
- 2** From the Vocal Harmony Type Selection display, use the TAB [◀][▶] buttons to select the SYNTH VOCODER tab.



- 3** Use the [A]–[J] buttons to select the desired Synth Vocoder type.
- 4** If necessary, press the [VOCAL HARMONY] button to turn the function on.
- 5** Try holding down a note on the keyboard and speak or sing into the microphone.

Also, try changing notes as you say/sing different words, hitting a separate note for each word.

**NOTE**

You can change the Keyboard setting (OFF/UPPER/LOWER), determining which part of the keyboard (or Song) controls the effect. Press [VH TYPE SELECT] → [8 ▲] (SETUP) → [4 ▲▼]/[5 ▲▼] (KEYBOARD). For details, refer to the Reference manual on the website.

# 9

# Mixing Console

– Editing the Volume and Tonal Balance –

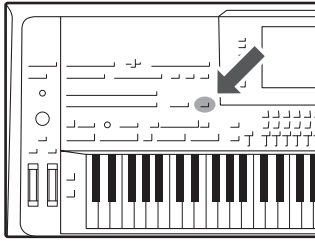

The Mixing Console gives you intuitive control over aspects of the keyboard parts and Style/MIDI Song channels, including volume balance and the timbre of the sounds. It lets you adjust the levels and stereo position (pan) of each Voice to set the optimum balance and stereo image, and lets you set how the effects are applied.

## Basic Procedure

- 1 Press the [MIXING CONSOLE] button to call up the MIXING CONSOLE display.



- 2 Press the [MIXING CONSOLE] button repeatedly to call up the MIXING CONSOLE display for the relevant parts.

The part name is indicated at the top of the display.

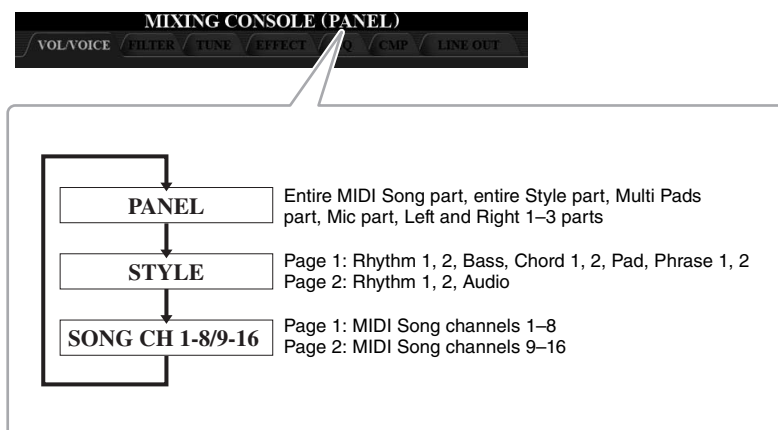

**NOTE**

For displays having PAGE 1 and PAGE 2, switch between the pages by pressing the [A] (PART) button.

⇓ NEXT PAGE



### 3 Use the TAB [◀][▶] buttons to call up the desired page.

For details about each page, refer to the Reference Manual on the website.

- **VOL/VOICE** .....Changes the Voice for each part and adjusts panning and volume for each part.
- **FILTER** .....Adjusts the Harmonic Content (resonance) and sound brightness.
- **TUNE**.....Pitch-related settings (tuning, transpose, etc.).
- **EFFECT** .....Selects effect type and adjusts its depth for each part.
- **EQ** .....Adjusts equalization parameters to correct the tone or timbre of the sound.
- **CMP** .....This is the Master Compressor setting which determines the dynamics of the overall sound. See page 94.
- **LINE OUT** .....You can specify the output of each part to any of the LINE OUT jacks. For Drum Parts, you can even select specific instruments to be output through any LINE OUT jack.

 **NOTE**

The Master Compressor is not applied to audio playback or the Metronome sound.

### 4 Use the [A]–[J] buttons to select a parameter, then use the [1]–[8] sliders/buttons to set the value for each part.

 **NOTE**

To reset each parameter to the default value, press the [▲] and [▼] of the corresponding button ([1]–[8]) simultaneously.

### 5 Save your Mixing Console settings.

• **To save the PANEL display settings:**

Register them to Registration Memory (page 85).

• **To save the STYLE display settings:**

Save them as Style data. If you want to recall the settings for future use, select the Style file saved here.

- 1** Call up the operation display.  
[CREATOR] → [B] STYLE CREATOR
- 2** Press the [EXIT] button to close the RECORD display.
- 3** Press the [I] (SAVE) button to call up the Style Selection display, then save it (page 29).

 **NOTE**

You can instantly set the same parameter value to all, if you simultaneously hold down one of the [A]–[J] buttons and use the [1 ▲▼]–[8 ▲▼] buttons (or the DATA ENTRY dial).

• **To save the SONG CH 1–8/9–16 display settings:**

First register the edited settings as part of the Song data (SETUP), then save the Song. If you want to recall the settings for future use, select the Song file saved here.

- 1** Call up the operation display.  
[CREATOR] → [A] SONG CREATOR
- 2** Use the TAB [◀][▶] buttons to select the CHANNEL page.
- 3** Use the [A]/[B] buttons to select “SETUP.”
- 4** Press the [D] (EXECUTE) button.
- 5** Press the [I] button to call up the Song Selection display, then save it (page 29).

# Master Compressor

Compressor is an effect commonly used to limit and compress the dynamics (softness/loudness) of an audio signal. For signals that vary widely in dynamics, such as vocals and guitar parts, it “squeezes” the dynamic range, effectively making soft sounds louder and loud sounds softer. When used with gain to boost the overall level, this creates a more powerful, more consistently high-level sound.

## Editing Master Compressor Settings

Select the CMP page in step 3 on page 93.

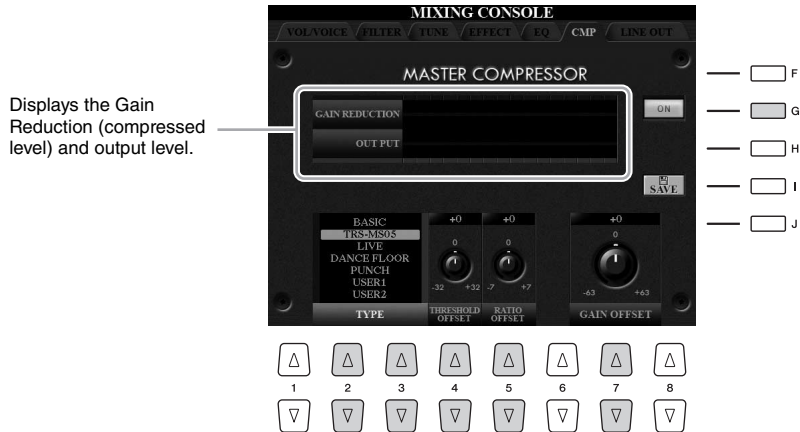

[G]	ON/OFF	Turns the Master Compressor effect on or off.
[2 ▲▼]/ [3 ▲▼]	TYPE	Selects a Master Compressor type.  <b>NOTE</b> By default, the type is set to “TRS-MS05” (the most appropriate setting for use with the optional TRS-MS05 speaker system).
[4 ▲▼]	THRESHOLD OFFSET	Determines the threshold (minimum level at which compression starts).
[5 ▲▼]	RATIO OFFSET	Determines the ratio of compression (how much the dynamic range is compressed).
[7 ▲▼]	GAIN OFFSET	Determines the output level.

## Saving Master Compressor Settings

The Master Compressor settings you have edited on page 94 can be saved as the User Compressor type.

- 1** Press the [I] (SAVE) button to enter the USER MASTER COMPRESSOR display.

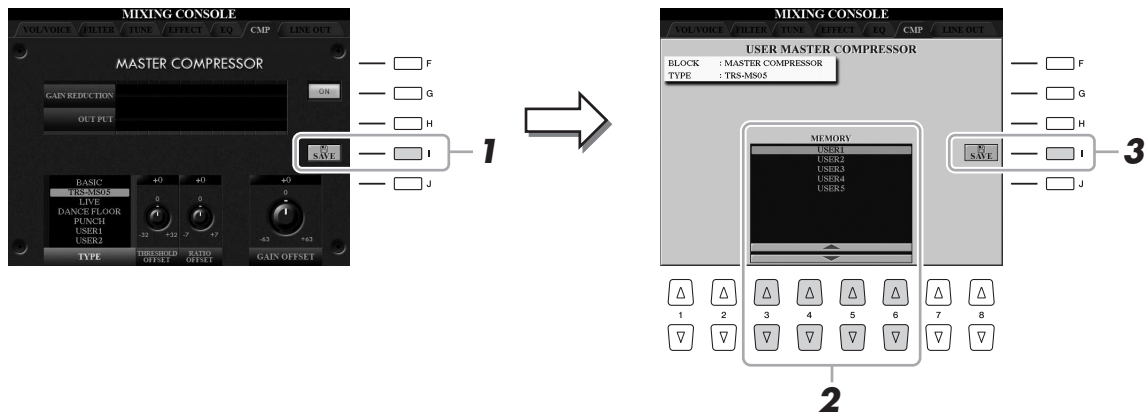

- 2** Select the destination to which the User Master Compressor is to be saved, by using the [3 ▲▼]–[6 ▲▼] buttons.
- 3** Press the [I] (SAVE) button to open the SAVE display.
- 4** Enter the name (page 34) of the edited Compressor type, then press the [8 ▲] (OK) button to actually save the settings.
- 5** Press the [EXIT] button to return to the previous display.

The saved Compressor type is shown in the TYPE selection at the bottom left of the display.

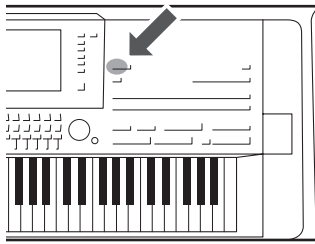

The Utility section in the Function menu provides a variety of convenient tools and settings for the Tyros5. These include general settings that affect the entire instrument, as well as detailed settings for specific functions. Also included are data reset functions and storage media control, such as disk formatting.

### Basic Procedure

#### 1 Call up the operation display.

[FUNCTION] → [H] UTILITY

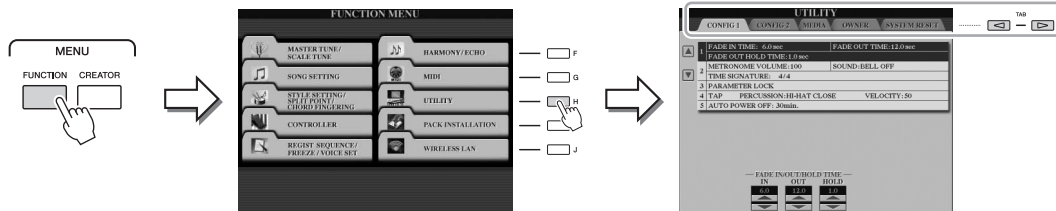

#### 2 Use the TAB [◀][▶] buttons to call up the desired page.

- **CONFIG1** ..... General settings such as Fade in/out time, Metronome sound, Parameter Lock, Tap Tempo sound, Auto Power Off.
- **CONFIG2** ..... General settings such as LINE OUT output, pop-up display time, S.Art2! auto articulation, etc.
- **MEDIA** ..... Settings related to installed media (internal hard disk drive or USB flash memory), such as formatting (page 102) and confirming memory size.
- **OWNER** ..... Settings of Owner name, Message language (page 18) and background of the Main display. Parameter setting backup/restore operations (page 35) can also be done in this page.
- **SYSTEM RESET** ..... Saves/Resets the settings of the instrument.

For details of the Utility settings, refer to the Reference Manual on the website.

#### 3 If necessary, use the [A]/[B] buttons to select the desired parameter.

#### 4 Change the settings by using the [1 ▲▼]–[8 ▲▼] buttons or execute the operation by using the [A]–[J] buttons.

This chapter covers the connectors of this instrument. To see where the connectors are located on the instrument, refer to pages 14–15.

 **CAUTION**

Before connecting the instrument to other electronic components, turn off the power of all components. Also, before turning any components on or off, make sure to set all volume levels to minimum (0). Otherwise, damage to the components, electrical shock, or even permanent hearing loss may occur.

## Connecting a Microphone ([MIC INPUT] jack)

By connecting a microphone, you can enjoy singing along with your keyboard performance or with Song playback, as well as recording your vocal performance using the Audio Recorder function. Make sure you have a conventional dynamic microphone.

For instructions on connecting a microphone, refer to page 88.

## Connecting Audio Devices (LINE OUT jacks, AUX IN jacks)

### Connecting the Optional Yamaha TRS-MS05 Speaker

For instructions, refer to pages 106–107.

 **IMPORTANT**

Since the Tyros5 has no built-in speakers, you need to monitor its sound output via external audio equipment. Alternatively, you could use a pair of headphones (page 15).

## Using External Audio Devices for Playback

The [LINE OUT] jacks are used to send the Tyros5 output to a keyboard amplifier, stereo sound system or mixing console. If you are connecting the Tyros5 to a mono sound system, use only the [L/L+R] jack. When only this jack is connected (using a standard phone plug), the left and right channels are combined and output through this jack—providing a convenient mono mix of the Tyros5's stereo sound.

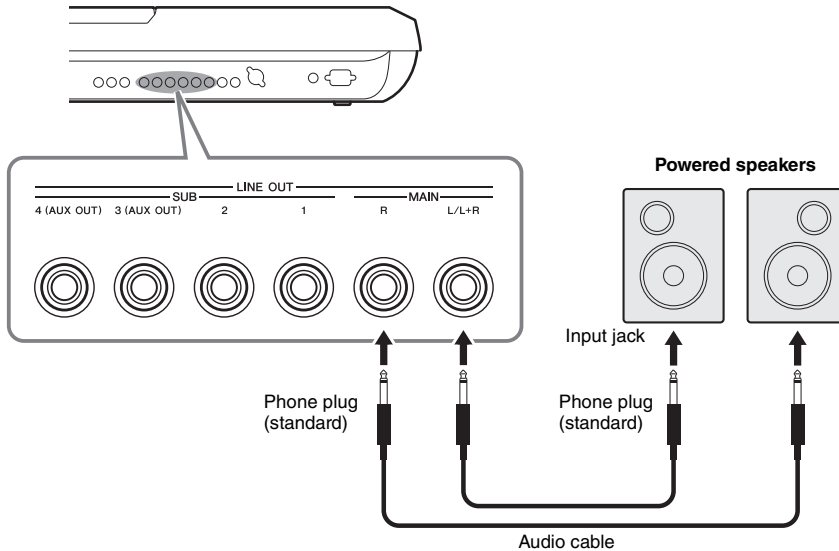

### **NOTE**

You can send a specific part to any desired LINE OUT SUB jack. The operation display can be called up via: [MIXING CONSOLE] → TAB [◀][▶] LINE OUT. For details, refer to the Reference Manual on the website.

### **NOTICE**

To avoid possible damage, first turn on the power to the instrument, then to the external device. When turning off the power, first turn off the power to the external device, then to the instrument. Since this instrument's power may automatically be turned off due to the Auto Power Off function (page 17), turn off the power to the external device, or disable Auto Power Off when you do not intend to operate the instrument.

### Switching the role of the LINE OUT SUB [3]–[4] jacks to AUX OUT jacks

You can switch the role of the LINE OUT SUB [3]–[4] jacks to AUX OUT jacks by the instrument's display called up via [MIXING CONSOLE] → TAB [◀][▶] LINE OUT. For details, refer to the Reference Manual on the website.

#### **NOTICE**

Do not route the output from the AUX OUT jacks to the AUX IN jacks. If you make this connection, the signal input at the AUX IN jacks is output from the AUX OUT jacks, possibly resulting in a feedback loop that will make normal performance impossible, and may even damage the equipment.

#### **NOTE**

The output volume from AUX OUT jacks cannot be controlled by MASTER VOLUME.

## Playing External Audio Devices with the Tyros5

You can connect the output jacks of an external device (such as CD player, portable audio player, tone generator etc.) to the instrument's AUX IN [L/L+R]/[R] jacks, letting you hear the sound of that device through the headphones or the optional Yamaha TRS-MS05 speakers of the Tyros5.

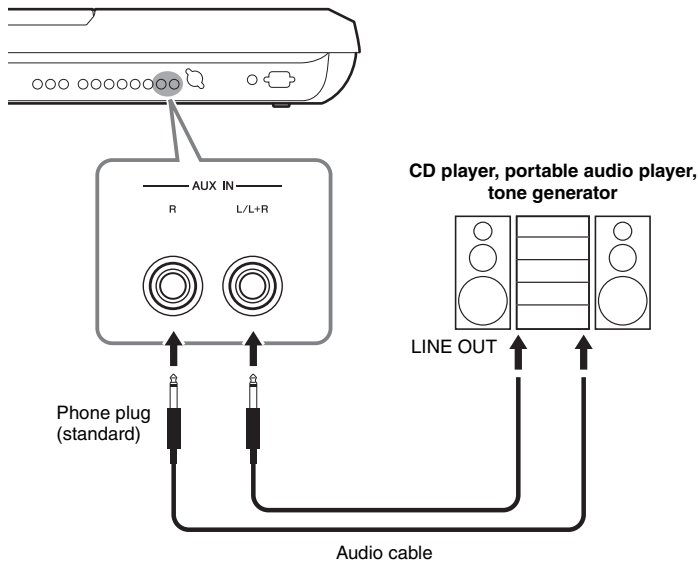

### NOTICE

To avoid damage to the devices, first turn on the power to the external device, then to the instrument. When turning off the power, first turn off the power to the instrument, then to the external device.

### NOTE

Use only the [L/L+R] jack for connection with a monaural device.

### NOTE

The input signal from the AUX IN jacks is affected by the setting of the instrument's [MASTER VOLUME] dial, and the volume balance with other parts such as entire keyboard can be adjusted by the BALANCE display (page 61).

## Connecting an External Monitor ([RGB OUT] terminal)

By connecting an external monitor to the [RGB OUT] terminal of the instrument, you can have the lyrics, text and display of the instrument's LCD shown on the monitor.

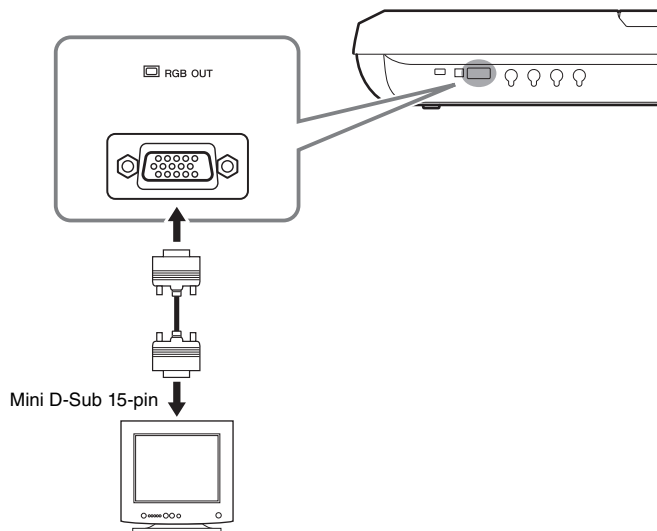

### NOTE

If the display is not aligned properly in the computer monitor, change the settings on the monitor itself.

### CAUTION

Avoid looking at the monitor for prolonged periods of time since doing so could damage your eyesight. Take frequent breaks and focus your eyes on distant objects to avoid eyestrain.

### ● Selecting display contents for the external monitor

To do this, call up the display via [FUNCTION] → [H] (UTILITY) → TAB [◀][▶] CONFIG 2 → [A]/[B] "1 SCREEN CONTENT," then use the [5 ▲▼]/[6 ▲▼] button. When you select "LYRICS/TEXT," the connected monitor shows the LYRICS or TEXT display regardless of what is shown on the instrument's LCD. When you select "LCD," the monitor shows the same contents as shown on the instrument's LCD.

## Connecting Footswitches/Foot Controllers (ASSIGNABLE FOOT PEDAL jacks)

One or two optional Yamaha FC4 or FC5 Footswitches and an optional Yamaha FC7 Foot Controller can be connected to one of these ASSIGNABLE FOOT PEDAL jacks. A footswitch can be used for switching functions on and off, while a foot controller controls continuous parameter such as volume.

 **NOTE**

Do not connect or disconnect the pedal when the power is on.

With the initial factory settings, each jack features the following function.

- **1 (SUSTAIN)** .....Controls sustain.
- **2 (ART. 1)** .....Controls an articulation effect on a Super Articulation/  
Super Articulation 2 Voice.
- **3 (VOLUME)** .....Controls volume.

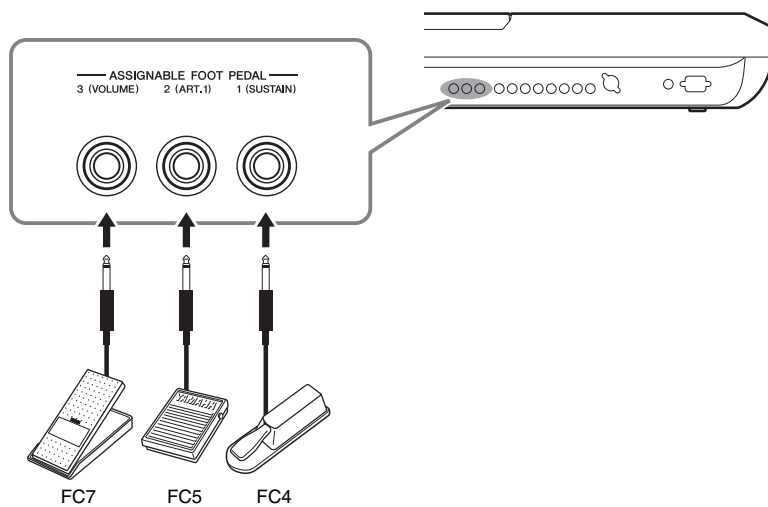

You can also change the function assignments to the pedals as desired.

### ● Example: Controlling Song Start/Stop by footswitch

Connect a footswitch (FC4 or FC5) to one of the ASSIGNABLE FOOT PEDAL jacks. To assign the function to the connected pedal, select “SONG PLAY/PAUSE” in the operation display: [FUNCTION] → [D] CONTROLLER → TAB [◀][▶] FOOT PEDAL.

For the functions you can assign to the pedals, refer to the Reference Manual on the website.



## Connecting USB Devices ([USB TO DEVICE] terminal)

You can connect a USB flash memory or a USB wireless LAN adaptor to the [USB TO DEVICE] terminal. You can save data you've created on the instrument to the USB flash memory (page 29), or you can connect the instrument to a smart device such as iPad via wireless LAN (page 102).

### Precautions when using the [USB TO DEVICE] terminal

When connecting a USB device to the terminal, be sure to handle the USB device with care. Follow the important precautions below.

#### NOTE

For more information about the handling of USB devices, refer to the owner's manual of the USB device.

#### ● Compatible USB devices

- USB flash memory
- USB wireless LAN adaptor (which is included only in some areas)

Other USB devices such as a computer keyboard or mouse cannot be used.

The instrument does not necessarily support all commercially available USB devices. Yamaha cannot guarantee operation of USB devices that you purchase. Before purchasing a USB device for use with this instrument, please visit the following web page:

<http://download.yamaha.com/>

#### NOTE

The rating of the [USB TO DEVICE] terminal is a maximum of 5V/500mA. Do not connect USB devices having a rating above this, since this can cause damage to the instrument itself.

#### ● Connecting USB device

When connecting a USB device to the [USB TO DEVICE] terminal, make sure that the connector on the device is appropriate and that it is connected in the proper direction.

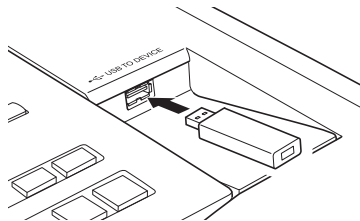

#### **NOTICE**

- Avoid connecting or disconnecting the USB device during playback/recording, file management (such as Save, Copy, Delete and Format operations) or when accessing the USB device. Failure to do so may result in "freezing" of the operation of the instrument or corruption of the USB device and the data.
- When connecting then disconnecting the USB device (and vice versa), make sure to wait a few seconds between the two operations.

#### NOTE

When connecting a USB cable, make sure that the length is less than 3 meters.

#### ● Using USB flash memory

By connecting a USB storage device to the instrument, you can save data you've created to the connected USB flash memory, as well as read data from the connected USB flash memory.

#### ● Formatting USB flash memory

When a USB storage device is connected, a message may appear prompting you to format the USB flash memory. If so, execute the Format operation (page 102).

#### **NOTICE**

The Format operation deletes any previously existing data. Make sure that the USB flash memory you are formatting does not contain important data. Proceed with caution, especially when connecting multiple USB flash memories.

#### ● To protect your data (write-protect)

To prevent important data from being inadvertently erased, apply the write-protect function provided with each USB flash memory. If you are saving data to the USB storage device, make sure to disable write-protect.

#### ● Turning off the instrument

When turning off the instrument, make sure that the instrument is NOT accessing the USB flash memory by playback/recording or file management (such as during Save, Copy, Delete and Format operations). Failure to do so may corrupt the USB flash memory and the data.

## Formatting a USB Storage Device or Internal Hard Disk Drive

To format a USB storage device or internal hard disk drive, execute the format operation.

If you want to format a USB storage device, make sure that a USB storage device is connected to the [USB TO DEVICE] terminal beforehand.

### 1 Call up the operation display.

[FUNCTION] → [H] UTILITY → TAB [◀][▶] MEDIA

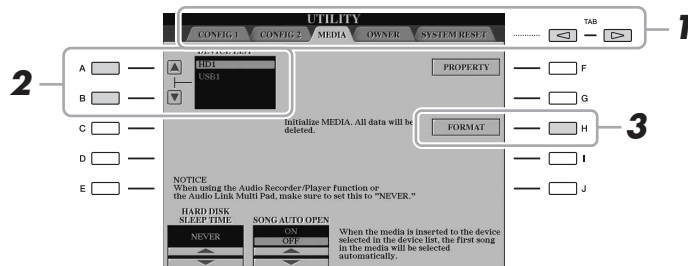

### NOTICE

The format operation deletes any previously existing data. Make sure that the device you are formatting does not contain important data. Proceed with caution, especially when connecting multiple USB flash memories.

### 2 Press the [A]/[B] buttons to select the USB storage device or internal hard disk (HD) drive to be formatted from the device list.

The indications USB 1, USB 2, etc. will be displayed depending on the number of the connected devices.

### 3 Press the [H] (FORMAT) button to execute the Format operation.

### 4 Follow the on-display instructions.

### NOTE

When the internal hard disk drive is formatted, the Tyros5 will be restarted automatically.

## Connecting to an iPhone/iPad ([USB TO DEVICE], [USB TO HOST] and MIDI terminals)

You can use a smart device, such as an iPhone or iPad, with the instrument for a variety of musical purposes by connecting it to the [USB TO DEVICE] terminal via the USB wireless LAN adaptor (if included). The USB wireless LAN adaptor may not be included depending on your locale due to local regulations. If the USB wireless LAN adaptor is not included, connect the smart device to the MIDI terminals via the Yamaha i-MX1 (optional) or to the [USB TO HOST] terminal via the Yamaha i-UX1 (optional). By using application tools on your smart device, you can take advantage of convenient functions and get more enjoyment out of this instrument.

For details on connections, refer to the “iPhone/iPad Connection Manual” and the Reference Manual on the website (page 10).

For information about the compatible smart devices and application tools, access the following page:

<http://www.yamaha.com/kbdapps/>

Yamaha does not guarantee or support use of the included USB wireless LAN adaptor with any devices other than this instrument.

### NOTE

- Before using the [USB TO DEVICE] terminal, be sure to read “Precautions when using the [USB TO DEVICE] terminal” on page 101.
- When you use the instrument along with an application on your iPhone/iPad, we recommend that you first set “Airplane Mode” to “ON” then set “Wi-Fi” to “ON” on your iPhone/iPad in order to avoid noise caused by communication.

### NOTICE

Do not place your iPhone/iPad in an unstable position. Doing so may cause the device to fall and result in damage.

## Connecting to a Computer ([USB TO HOST] terminal)

By connecting a computer to the [USB TO HOST] terminal, you can transfer data between the Tyros5 and the computer via MIDI. For details on using a computer with this instrument, refer to the “Computer-related Operations” on the website.

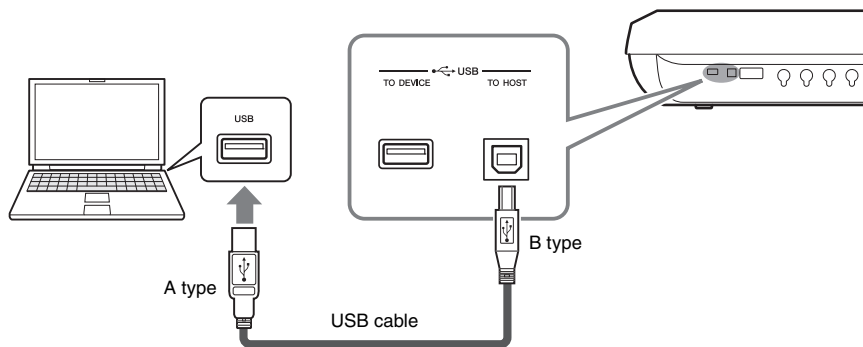

### NOTICE

Use an AB type USB cable of less than 3 meters. USB 3.0 cables cannot be used.

### NOTE

- When using a USB cable to connect the instrument to your computer, make the connection directly without passing through a USB hub.
- The instrument will begin transmission a short time after the USB connection is made.
- For information on setting up your sequence software, refer to the owner's manual of the relevant software.
- You can also use the MIDI [IN]/[OUT] terminals to connect to a computer. In this case, a USB-MIDI interface (such as the Yamaha UX16) is needed. For more information, refer to the owner's manual of the USB-MIDI interface.

## Accessing an Internal Hard Disk Drive on the Tyros5 from the Computer (USB Storage Mode)

When the instrument is in the USB Storage Mode, Wave files and Song files can be transferred between the internal hard disk drive of the Tyros5 and the computer. When the instrument is NOT in the USB Storage Mode, the USB connection can be used for MIDI control. The USB interface does not directly handle audio signals.

### NOTE

The USB Storage Mode can be used with Windows XP/Vista/7/8.

- 1** Turn the computer's power on.
- 2** Turn the Tyros5's power on while holding the [MUSIC FINDER] button to enter the USB Storage Mode.

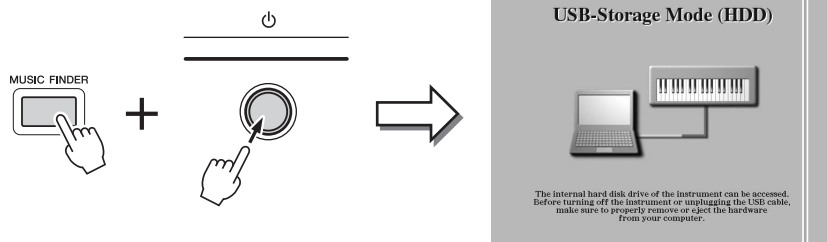

Flashes during access.

### NOTE

The instrument does not execute the functions from the panel and pedals, or receive MIDI signals while the instrument is in the USB Storage Mode.

- 3** Manage files/folders in the internal hard disk drive of the Tyros5 by using the computer.

While the computer is accessing the internal hard disk drive of the Tyros5, the lamp at upper right corner on the display flashes.

- 4** To exit the USB Storage Mode, press the [EXIT] button.

### **NOTICE**

Execute the following before entering/exiting the USB Storage Mode.

- Close all application programs.
- If the instrument is NOT in the USB Storage Mode, make sure that data is not being transmitted from the Tyros5.
- If the instrument is in the USB Storage Mode, make sure that no file reading or writing operation is in progress.
- If the instrument is in the USB Storage Mode, safely remove the Tyros5 hard disk icon from the Windows taskbar.

### **NOTICE**

Never disconnect the USB cable or turn off the power while the lamp at upper right corner on the display is flashing.

### **NOTICE**

Do not format the hard disk drive or change the volume label from a computer when accessing the drive via the USB storage mode. If you do this, the drive may not be able to be used in the Audio Recorder/Player function.

### **NOTICE**

Do not access the AUDIOREC.ROOT folder containing the audio files that you have created with the Audio Recorder function. If you access the folder or make changes to it (moving the folder or copying some files in the folder, etc.), your important data will be deleted or damaged.

## Connecting External MIDI Devices (MIDI terminals)

Use the [MIDI] terminals and standard MIDI cables to connect external MIDI devices (keyboard, sequencer, etc.)

- **MIDI IN**.....Receives MIDI messages from another MIDI device. Two ports (A, B) are provided and each can receive MIDI messages over 16 channels.
- **MIDI OUT** .....Transmits MIDI messages generated by the Tyros5 to another MIDI device. Two ports (A, B) are provided and each can transmit MIDI messages over 16 channels.

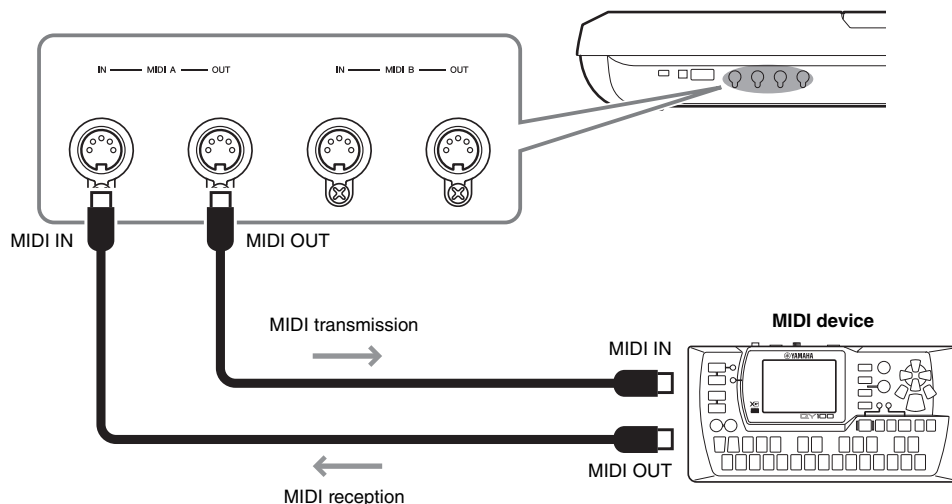

The MIDI settings such as transmit/receive channels on the instrument can be set via [FUNCTION] → [G] (MIDI) → [8 ▼] (EDIT). For details, refer to the Reference Manual on the website.

## Installing the Optional Speakers

Make sure that you have all of the parts below, included in the TRS-MS05 speaker package. Connect the satellite speakers, subwoofer speaker, and the Tyros5 via the included cable as shown.

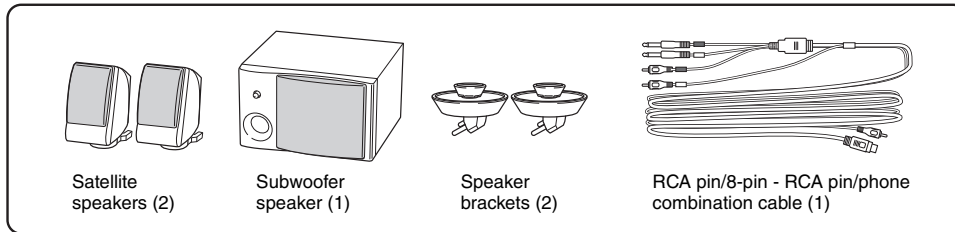

**1** Turn the Tyros5's power off, and disconnect the AC power cord. Also, make sure to disconnect the keyboard from any other external devices.

**2** Insert the two speaker brackets to the outside slots on the rear panel of the Tyros5.

Tyros5-76 has two additional sets of slots (as shown).

**NOTE**  
The brackets can be inserted interchangeably to either location.

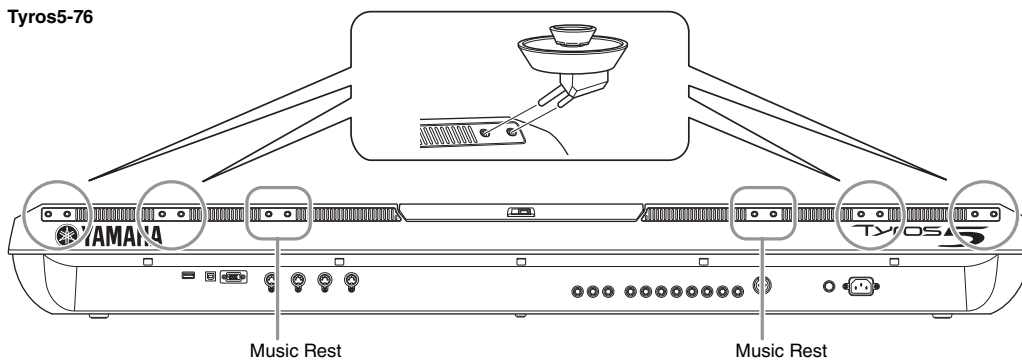

**3** Fasten the satellite speakers to the left and right brackets.

**NOTE**  
The satellite speakers can be installed interchangeably to either location.

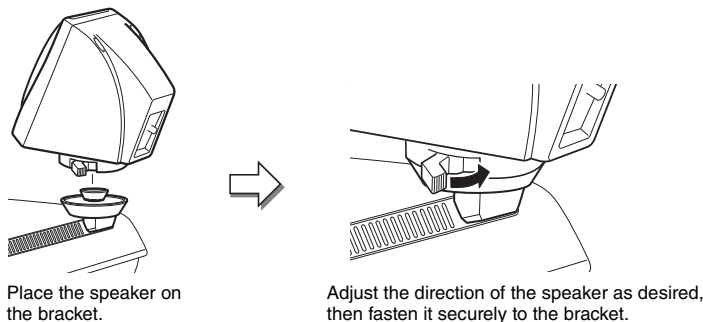

**4** Connect the satellite speakers, subwoofer speaker, and the Tyros5 via the included cable as shown.

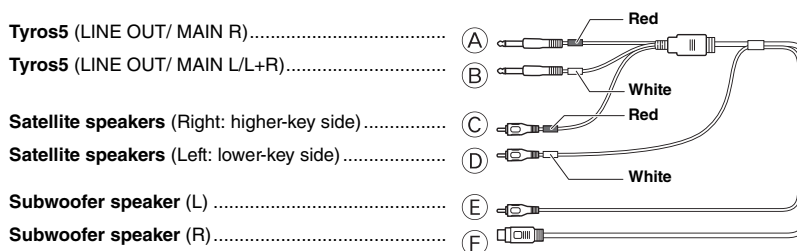

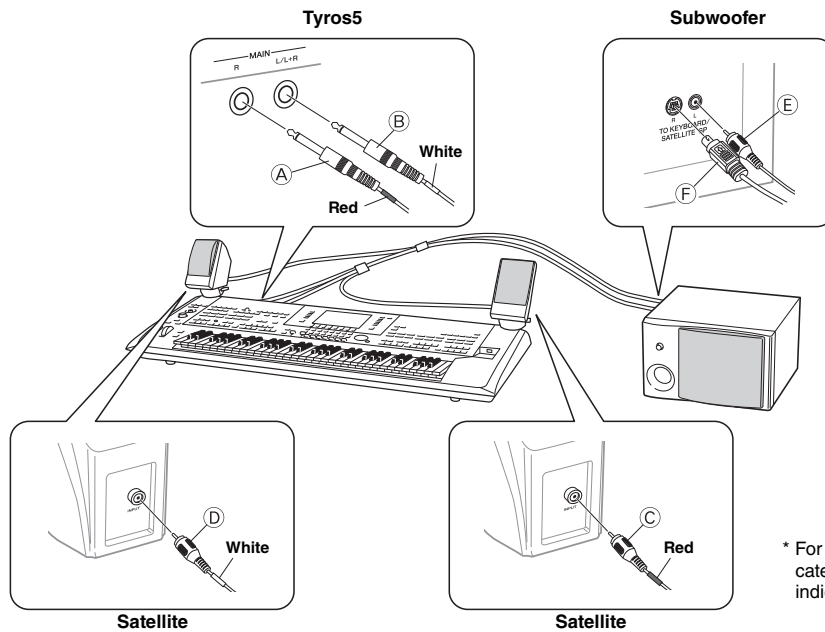

\* For stereo audio cables, red indicates the right channel, and white indicates the left.

- 5** Connect the power plugs of the Tyros5 and the subwoofer to an appropriate AC outlet.
- 6** Set the volume controls (**MASTER VOLUME** on the Tyros5 and **MASTER VOLUME** on the subwoofer) to minimum.

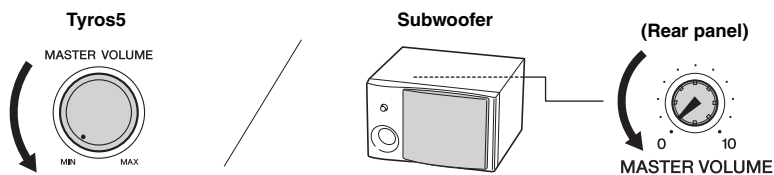

- 7** Turn on the power of the Tyros5, then the subwoofer.

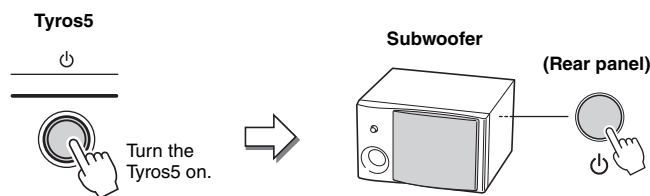

- 8** Adjust the volume controls (**MASTER VOLUME** on the Tyros5 and **MASTER VOLUME** on the subwoofer) to appropriate levels.

### Routing the cable

On the rear panel of the Tyros5, hooks are provided for neatly routing the cable. Fixing the cable to these hooks (as shown below) prevents it from dangling loosely from the instrument.

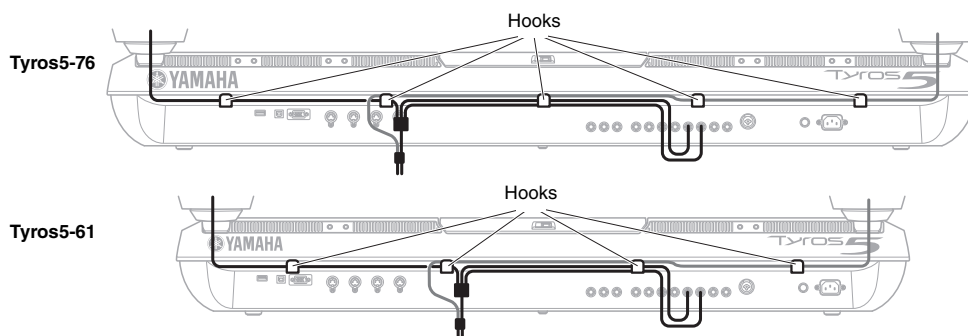

# Installing the Optional Flash Memory Expansion Module

Installing an optional flash memory expansion module to the Tyros5 allows you to add a variety of Voices by installing an Expansion Pack. This section explains how to install an expansion module to the Tyros5.

## **WARNING**

- Before beginning installation, switch off the power to the Tyros5 and connected peripherals, and unplug them from the power outlet. Installation or removal of any devices should be started **ONLY** after the instrument (and the optional hardware) returns to normal room temperature. Then remove all cables connecting the Tyros5 to other devices. (Leaving the power cord connected while working can result in electric shock. Leaving other cables connected can interfere with work.)
- Be careful not to drop any screws inside the instrument during installation (this can be prevented by keeping the optional unit and cover away from the instrument while attaching). If this does happen, be sure to remove the screw(s) from inside the instrument before turning the power on. Loose screws inside the instrument can cause improper operation or serious damage. If you are unable to retrieve a dropped screw, consult your Yamaha dealer for advice.
- Install the optional unit carefully as described in the procedure below. Improper installation can cause shorts which may result in irreparable damage and pose a fire hazard.
- Do not disassemble, modify, or apply excessive force to board areas or the connector on an optional module unit. Bending or tampering with the board and connector may lead to electric shock, fire, or equipment failures.

## **CAUTION**

- Do not touch the exposed metal parts in the circuit board. Touching these parts may result in a faulty contact.
- Be careful not to misplace any of the screws since all of them are used.
- Be careful of static electricity. Static electricity discharge can damage the module or the instrument. Before you handle the module, to reduce the possibility of static electricity, touch some unpainted metal surface or a ground wire on a device that is grounded.
- Do not use any screws other than what are installed on the instrument.
- It is recommended that you wear gloves to protect your hands from metallic projections on the optional unit and other components. Touching leads or the connector with bare hands may cause finger cuts, and may also result in poor electrical contact or electrostatic damage.
- Handle the optical unit with care. Dropping or subjecting it to any kind of shock may cause damage or result in a malfunction.

## Compatible Flash Memory Expansion Modules

Two types of the module are available as follows:

- **FL512M**..... Features a memory size of 512 MB.
- **FL1024M**..... Features a memory size of 1024 MB.

## **NOTE**

In the Tyros5, one socket is available.

## Flash Memory Expansion Module Installation

Before following the steps below, make sure you have appropriate module, a Philips screwdriver and ample space to work.

- 1 Turn the Tyros5's power off, and disconnect any cables including AC power cord from the keyboard.**

Also make sure to close the LCD panel and disconnect the Tyros5 from any connected external devices.

- 2 Turn the Tyros5 face down on a blanket or some soft surface, giving you direct access to the bottom of the instrument.**

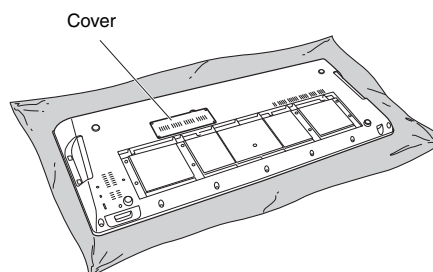

## **CAUTION**

Since the instrument is heavy, this procedure should not be done alone, but by two or three people.

 **NEXT PAGE**



**3** Remove the four screws from the cover.

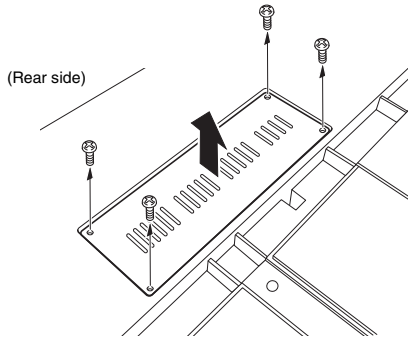

**NOTE**

Keep the removed screws in a safe place. They will be used when reattaching the cover to the instrument after installation.

**4** Insert the module into the socket by following the procedure below.

**4-1** Insert the module vertically in the socket and position the screws (of the module) to the female screws respectively.

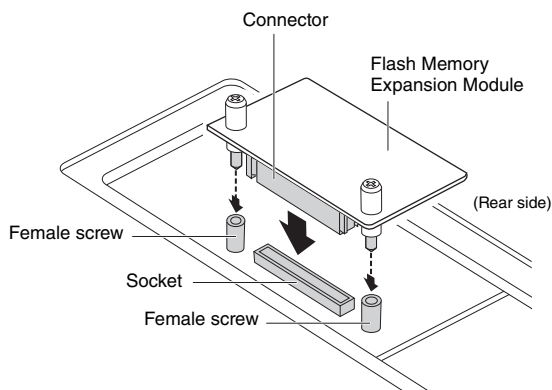

**4-2** Press the top of the connector as shown, then push the connector firmly into the socket.

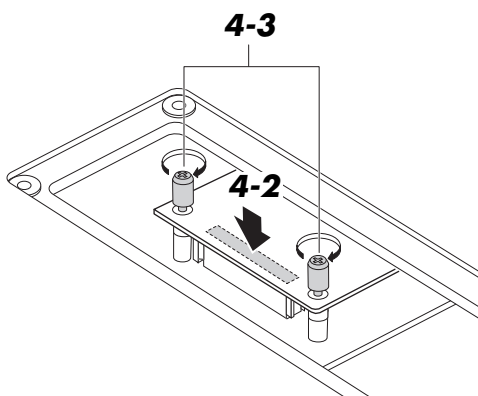

**4-3** Tighten each screw of the module to each female screw of the Tyros5 with your hand as shown.

**5** Re-install the cover you removed in step 3, in reverse order.

## Removing Flash Memory Expansion Module

**1** Loosen both the screws with your hand as shown below.

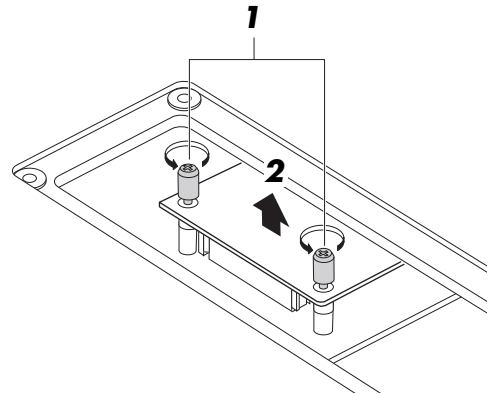

**NOTICE**

- If you cannot loosen the screws with your hand, use a Phillips screwdriver. In this case, be careful NOT to scratch the module or the Tyros5.
- Be careful NOT to drop the screws inside the instrument when loosening them.

**2** Pull the module vertically out of the socket.

**3** Attach the cover to the bottom panel.

# Direct Access Chart

Operation: [DIRECT ACCESS] button + button/controller listed below		Function of the accessed LCD display				
STYLE CONTROL	ACMP	FUNCTION	STYLE SETTING/ SPLIT POINT/ CHORD FINGERING	CHORD FINGERING	FINGERING TYPE SETTING	
	OTS LINK			STYLE SETTING		
	AUTO FILL IN			CHORD FINGERING	FINGERING TYPE SETTING	
	INTRO I	MIXING CONSOLE		VOL/VOICE (STYLE)	VOICE	
	INTRO II			PANPOT		
	INTRO III			VOLUME		
	MAIN A			FILTER	HARMONIC CONTENT	
	MAIN B			BRIGHTNESS		
	MAIN C			EFFECT	REVERB	
	MAIN D			CHORUS		
	BREAK			DSP		
	ENDING/rit. I			EQ (STYLE)	EQ HIGH	
	ENDING/rit. II			EQ LOW		
	ENDING/rit. III	MASTER COMP				
SYNC STOP	FUNCTION	STYLE SETTING/ SPLIT POINT/ CHORD FINGERING	STYLE SETTING	SYNCHRO STOP WINDOW SETTING		
SYNC START			SPLIT POINT	SPLIT POINT (STYLE) SETTING		
START/STOP			STYLE SETTING	SYNCHRO STOP WINDOW SETTING		
STYLE	POP & ROCK	MIXING CONSOLE		VOL/VOICE (STYLE)	VOICE	
	BALLAD			PANPOT		
	DANCE			VOLUME		
	SWING & JAZZ			FILTER (STYLE)	HARMONIC CONTENT	
	R&B			BRIGHTNESS		
	COUNTRY			EFFECT (STYLE)	REVERB	
	LATIN			CHORUS		
	BALLROOM			DSP		
	MOVIE & SHOW			EQ (STYLE)	EQ HIGH	
	ENTERTAINER			EQ LOW		
	WORLD			EQ	MASTER EQ EDIT	
	FILE ACCESS			LINE OUT	LINE OUT PANEL	
	SONG			I	MIXING CONSOLE	
II		FILTER (SONG 1-8)	HARMONIC CONTENT			
III		VOL/VOICE (SONG 9-16)	VOICE			
IV		FILTER (SONG 9-16)	HARMONIC CONTENT			
SP1		EFFECT (SONG 1-8)	REVERB			
SP2		EQ (SONG 1-8)	EQ HIGH			
SP3		EFFECT (SONG 9-16)	REVERB			
SP4		EQ (SONG 9-16)	EQ HIGH			
LOOP		FUNCTION	SONG SETTING			
REC						
STOP						
PLAY/PAUSE						
REW						
FF						
LYRICS/TEXT						
SCORE						
TIMING	TAP TEMPO	FUNCTION	UTILITY	CONFIG 1	TAP SETTING	
	TEMPO +			SYSTEM	MIDI CLOCK SETTING	
	TEMPO -			STYLE SETTING/ SPLIT POINT/ CHORD FINGERING	STYLE SETTING	
	METRONOME			UTILITY	CONFIG 1	METRONOME SETTING
	FADE IN/OUT			FADE IN/OUT SETTING		
TRANSPOSE	+	MIXING CONSOLE		TUNE	TRANSPOSE	
	-	FUNCTION	CONTROLLER	KEYBOARD/PANEL	TRANSPOSE ASSIGNMENT	
UPPER OCTAVE	+	MIXING CONSOLE		TUNE	OCTAVE	
	-					
AUDIO RECORDER/PLAYER	REC	BALANCE		PAGE2		
	STOP	FUNCTION	UTILITY	CONFIG 1	FADE IN/OUT SETTING	
	PLAY/PAUSE			CONFIG 2	LINE OUT (MAIN) SETTING	
	PREV			MEDIA		
	NEXT			OWNER		
	MODE			SYSTEM RESET		
MULTI PAD	SELECT	MULTI PAD SELECTION display		MULTI PAD EDIT		
	STOP					
	1			MULTI PAD EDIT		MULTI PAD 1
	2					MULTI PAD 2
	3					MULTI PAD 3
4	MULTI PAD 4					
DEMO		FUNCTION	UTILITY	OWNER	LANGUAGE SETTING	
MENU	FUNCTION	FUNCTION	MIDI TEMPLATE SETTING			
	CREATOR		MASTER TUNE/ SCALE TUNE	SCALE TUNE		

Operation: [DIRECT ACCESS] button + button/controller listed below		Function of the accessed LCD display					
MIXING CONSOLE		MIXING CONSOLE		VOL/VOICE (PANEL)	VOICE		
BALANCE		BALANCE		PAGE2/2			
CHANNEL ON/OFF		CHANNEL		STYLE SETTING			
EXIT		MAIN					
PART SELECT	LEFT	FUNCTION	REGIST SEQUENCE/ FREEZE/ VOICE SET	VOICE SET	LEFT		
	RIGHT1				RIGHT1		
	RIGHT2				RIGHT2		
	RIGHT3				RIGHT3		
PART ON/OFF	LEFT	FUNCTION	STYLE SETING/ SPLIT POINT/ CHORD FINGERING	SPLIT POINT	SPLIT POINT (LEFT) SETTING		
	RIGHT1				SPLIT POINT (RIGHT3) SETTING		
	RIGHT2						
	RIGHT3						
	LEFT HOLD				SPLIT POINT (LEFT) SETTING		
VOICE EFFECT	HARMONY ECHO	FUNCTION	HARMONY/ ECHO	KEYBOARD/PANEL	HARMONY ECHO SETTING		
	INITIAL TOUCH		CONTROLLER		INITIAL TOUCH		
	SUSTAIN				AFTER TOUCH		
	MONO	MIXING CONSOLE	TUNE	EFFECT (PANEL)	PORTAMENTO TIME SETTING		
	DSP				DSP DEPTH SETTING		
VARIATION		EFFECT	EFFECT TYPE				
VOICE	PIANO	MIXING CONSOLE		VOL/VOICE (PANEL)	VOICE		
	E. PIANO				PANPOT		
	ORGAN				VOLUME		
	STRINGS			FILTER (PANEL)	HARMONIC CONTENT		
	CHOIR				BRIGHTNESS		
	BRASS				PORTAMENTO TIME		
	WOODWIND			TUNE	PITCH BEND RANGE		
	A. GUITAR				OCTAVE		
	E. GUITAR				TUNING		
	BASS				REVERB		
	PERCUSSION			EFFECT (PANEL)	CHORUS		
	DRUM KIT				DSP		
	ACCORDION			EQ (PANEL)	EQ HIGH		
	PAD				EQ LOW		
	SYNTH			MASTER COMPRESSOR			
	ORGAN WORLD			LINE OUT	LINE OUT PANEL		
	ENSEMBLE			CONFIG 2-2	POPUP DISPLAY TIME		
	EXPANSION/USER			FUNCTION	UTILITY	SYSTEM RESET	
	ART. 1			FUNCTION	CONTROLLER	FOOT PEDAL	PEDAL 1
	ART. 2						PEDAL 2
MUSIC FINDER		MUSIC FINDER			MUSIC FINDER SEARCH 1		
ONE TOUCH SETTING	1	OTS INFORMATION					
	2						
	3						
	4						
MIC	VOCAL HARMONY	VOCAL HARMONY	VOCAL HARMONY EDIT (PART)/(DETAIL)				
	VOCAL EFFECT	VOCAL HARMONY	VOCAL HARMONY EDIT (OVERVIEW)				
	TALK	MIC SETTING		TALK			
	VH TYPE SELECT	VOCAL HARMONY	VOCAL HARMONY EDIT (OVERVIEW)				
	MIC SETTING	MIC SETTING		MIC SETTING MEMORY			
REGISTRATION MEMORY	REGIST BANK +	REGIST BANK SELECTION display	REGISTRATION EDIT		REGISTRATION		
	REGIST BANK -						
	FREEZE	FUNCTION	REGIST SEQUENCE/ FREEZE/VOICE SET	FREEZE			
	MEMORY			REGISTRATION SEQUENCE			
	1	REGIST INFORMATION					
	2						
	3						
	4						
	5						
	6						
7							
8							
PEDAL	PEDAL 1	FUNCTION	CONTROLLER	FOOT PEDAL	PEDAL 1		
	PEDAL 2				PEDAL 2		
	PEDAL 3				PEDAL 3		
WHEEL	MODULATION	FUNCTION	CONTROLLER	KEYBOARD/PANEL	MODULATION WHEEL		
	PITCH BEND	MIXING CONSOLE		TUNE	PITCH BEND RANGE		
SLIDER	ASSIGN	FUNCTION	CONTROLLER	ASSIGN SLIDER			
	1						
	2						
	3						
	4						
	5						
	6						
	7						
	8						
	Cross Fader	BALANCE	PAGE2				

# Panel Button Chart

- No.**..... Corresponds to the number in the “Panel Controls and Terminals” on page 12.
- Button/Control**..... Indicates the button/controller that you should use at first for entering the corresponding function.
- Display**..... Indicates the display title (and tab title) called up by operating the button/controller.
- Reference Manual** ..... “●” indicates that the detailed information is described in the Reference Manual (downloadable from website).

No.	Button/Control	Display	Page	Reference Manual		
①	Power on/off switch [⏻]	—	16	—		
②	MIC	[VOCAL HARMONY]	—	89	—	
		[VOCAL EFFECT]	—	—	●	
		[TALK]	—	90	—	
		[VH TYPE SELECT]	Vocal Harmony Type Selection display	89	●	
		[MIC SETTING]	MIC SETTING display	VOCAL TALK	88 88	● ●
③	[MIC GAIN] knob	—	88	—		
④	[MASTER VOLUME] dial	—	16	—		
⑤	[FADE IN/OUT]	—	54	—		
⑥	UPPER OCTAVE [-]/[+]	UPPER OCTAVE (pop-up)	46	—		
⑦	[PITCH BEND] wheel	—	47	—		
⑧	[MODULATION] wheel	—	47	—		
⑨	[ART. 1], [ART. 2]	—	40	—		
⑩	[PHONES] jack	—	15	—		
⑪	Keyboard	—	12	—		
⑫	SONG	[REC]	CHANNEL ON/OFF (pop-up)	SONG	68, 69	—
		[STOP]	—	—	68	—
		[PLAY/PAUSE]	—	—	71, 72	—
		[REW]/[FF]	SONG POSITION (pop-up)	—	72	●
		[I]–[IV]	Song Selection display	—	71	—
		[SP 1]–[SP 4]	—	—	74	●
		[LOOP]	—	—	75	—
		[METRONOME]	—	—	71	—
		[SCORE]	SCORE display	—	73	●
[LYRICS/TEXT]	LYRICS or TEXT display	—	73	●		
⑬	Cross Fader	—	79	—		
⑭	AUDIO RECORDER/PLAYER	[REC]	AUDIO RECORDER/PLAYER display	—	76	—
		[STOP]	—	—	76	—
		[PLAY/PAUSE]	—	—	78	—
		[PREV]/[NEXT]	AUDIO POSITION (pop-up)	—	79	—
		[MODE]	AUDIO RECORDER/PLAYER display, PLAYLIST	—	78	●
⑮	STYLE	[POP & ROCK]–[WORLD]	Style Selection display	—	51	—
		[FILE ACCESS]	—	—	28	—
⑯	TRANSPOSE [-]/[+]	TRANSPOSE (pop-up)	—	46	—	
⑰	[MIXING CONSOLE]	MIXING CONSOLE (PANEL) display	VOL/VOICE	—	93	●
		—	FILTER	—	93	●
		—	TUNE	—	93	●
		—	EFFECT	—	93	●
		—	EQ	—	93	●
		—	CMP	—	93	—
—	—	LINE OUT	—	93	●	

No.	Button/Control	Display	Page	Reference Manual		
18	STYLE CONTROL	[ACMP]	—	53	—	
		[OTS LINK]	—	56	—	
		[AUTO FILL IN]	—	54	—	
		INTRO [I]–[III]	—	53	—	
		MAIN VARIATION [A]–[D]	—	54	—	
		[BREAK]	—	54	—	
		ENDING/rit. [I]–[III]	—	53	—	
		[SYNC STOP]	—	53	—	
		[SYNC START]	—	53	—	
		[START/STOP]	—	53	—	
19	[TAP TEMPO]/ TEMPO	[TAP TEMPO]	—	54	—	
		TEMPO [-]/[+]	TEMPO (pop-up)	54	—	
20	MULTI PAD CONTROL	[SELECT]	MULTI PAD Selection display	64	●	
		[1]–[4]	—	64	—	
		[STOP]	—	64	—	
21	[CHANNEL ON/OFF]	CHANNEL ON/OFF (pop-up)	STYLE(1/2, 2/2), SONG	60 75	—	
22	[BALANCE]	BALANCE (pop-up)	1/2, 2/2	61	—	
23	LCD and related controls	TAB [◀][▶]	—	21	—	
		[A]–[J]	—	20	—	
		[DIRECT ACCESS]	—	23	—	
		[EXIT]	—	22	—	
		ASSIGN slider	—	21	—	
		[1]–[8] sliders	—	21	—	
	[1 ▲▼]–[8 ▲▼] buttons	—	21	—		
24	MENU	[FUNCTION]	MASTER TUNE/SCALE TUNE	MASTER TUNE	—	●
				SCALE TUNE	—	●
			SONG SETTING		—	●
			STYLE SETTING/SPLIT POINT/ CHORD FINGERING	STYLE SETTING	—	●
				SPLIT POINT	62	●
				CHORD FINGERING	55	●
			CONTROLLER	ASSIGN SLIDER	21	—
				FOOT PEDAL	—	●
				KEYBOARD/PANEL	—	●
			REGIST SEQUENCE/FREEZE/ VOICE SET	REGISTRATION SEQUENCE	—	●
				FREEZE	—	●
				VOICE SET	—	●
			HARMONY/ECHO		49	●
			MIDI	PRESET	—	●
				USER	—	●
			UTILITY	CONFIG1	96	●
				CONFIG2	96	●
				MEDIA	96	●
				OWNER	96	●
				SYSTEM RESET	96	●
	PACK INSTALLATION		50	—		
	WIRELESS LAN		102	●		

No.	Button/Control	Display	Page	Reference Manual		
24	MENU [CREATOR]	SONG CREATOR	REC MODE	—	●	
			CHANNEL	—	●	
			CHORD	—	●	
			1–16	—	●	
			SYS/EX.	—	●	
			LYRICS	—	●	
		STYLE CREATOR	BASIC	—	●	
			ASSEMBLY	—	●	
			GROOVE	—	●	
			CHANNEL	—	●	
			PARAMETER	—	●	
			EDIT	—	●	
MULTI PAD CREATOR	RECORD	—	●			
	EDIT	—	●			
25	[MUSIC FINDER]	MUSIC FINDER display	ALL	82	—	
			FAVORITE	—	●	
			SEARCH1	83	—	
			SEARCH2	83	—	
26	[DEMO]	DEMO display	17	—		
27	VOICE EFFECT	[HARMONY/ECHO]	—	49	—	
		[INITIAL TOUCH]	—	48	—	
		[SUSTAIN]	—	48	—	
		[MONO]	—	48	—	
		[DSP]	—	48	—	
		[VARIATION]	—	48	—	
28	VOICE	[PIANO]–[SYNTH]	Voice Selection display	36	—	
		[ORGAN WORLD]	ORGAN WORLD display	VINTAGE	42	●
			HOME	42	●	
			EURO	42	●	
			CONCERT	42	—	
			THEATRE	42	—	
		[ENSEMBLE]	ENSEMBLE VOICE display	44	●	
		[EXPANSION/USER]	Voice Selection display	36	—	
29	REGISTRATION MEMORY	REGIST BANK [-]/[+]	REGISTRATION BANK (pop-up)	87	—	
		[FREEZE]	—	86	●	
		[MEMORY]	REGISTRATION MEMORY CONTENTS display	85	—	
		[1]–[8]	—	86	—	
30	ONE TOUCH SETTING	[1]–[4]	—	56	●	
31	PART SELECT	[LEFT]–[RIGHT 3]	—	36	—	
		[LEFT HOLD]	—	39	—	
32	PART ON/OFF	[LEFT]–[RIGHT 3]	—	37	—	

# Troubleshooting

Overall	
A click or pop is heard when the power is turned on or off.	This is normal. Electrical current is being applied to the instrument.
The power is automatically turned off.	This is normal and due to the Auto Power Off function. If necessary, set the parameter of the Auto Power Off function (page 17).
Noise is heard from the instrument.	Noise may be heard if a mobile phone is used near the instrument or if the phone is ringing. Turn off the mobile phone, or use it further away from the instrument.
Noise is heard from the instrument's speakers or headphones when using the instrument with the application on iPhone/iPad.	When you use the instrument along with the application on your iPhone/iPad, we recommend that you set "Airplane Mode" to "ON" on your iPhone/iPad in order to avoid noise caused by communication.
In the LCD, there are some specific points that are always lit or unlit.	These are the result of defective pixels and occasionally occur in TFT-LCDs; they do not indicate a problem in operation.
There is a slight difference in sound quality among different notes played on the keyboard.	This is normal and is a result of the instrument's sampling system.
Some Voices have a looping sound.	
Some noise or vibrato is noticeable at higher pitches, depending upon the Voice.	
The overall volume is too low, or, no sound is heard.	The master volume may be set too low. Set it to an appropriate level with the [MASTER VOLUME] control.
	All keyboard parts are set to off. Use the PART ON/OFF [RIGHT 1]/[RIGHT 2]/[RIGHT 3]/[LEFT] button to turn it on (page 38).
	The volume of individual parts may be set too low. Raise the volume in the BALANCE display (page 61).
	Make sure the desired channel is set to on in the CHANNEL display (pages 60, 75).
	Headphones are connected, disabling the speaker output. Unplug the headphones.
	If volume control is assigned to the [ASSIGN] slider or foot controller, set it to an appropriate level.
	The [FADE IN/OUT] button is on, muting the sound. Press the [FADE IN/OUT] button to turn the function off.
	Connect the footswitch to the appropriate jack.
	Check whether the external speaker is connected and the volume control is adjusted properly (pages 98, 106).
The sound is distorted or noisy.	The volume may be turned up too high. Make sure all relevant volume settings are appropriate.
	This may be caused by certain effects or filter resonance settings. Check the effect or filter settings and change them accordingly, referring to the Reference Manual on the website.
Not all simultaneously played notes sound.	You are probably exceeding the maximum polyphony of the instrument. The instrument can play up to 128 notes at the same time including RIGHT 1/RIGHT 2/RIGHT 3/LEFT Voices, Style, Song, and Multi Pad notes. When the maximum polyphony is exceeded, the least important notes (such as soft notes and notes currently decaying) will stop sounding first.
The keyboard volume is lower than the Style/Song playback volume.	The volume of the keyboard parts may be set too low. Raise the volume in the BALANCE display (page 61).
	The [ASSIGN] slider may be set to a low level. (By default, keyboard volume is assigned to the [ASSIGN] slider.) Set it to an appropriate level.
The Main display does not appear even when turning the power on.	This may occur if a USB flash memory has been installed to the instrument. Installation of some USB flash memory may result a long interval between turning the power on and appearance of the Main display. To avoid this, turn the power on after disconnecting the device.
Some characters of the file/folder name are garbled.	The language settings have been changed. Set the appropriate language for the file/folder name (page 18).

An existing file is not shown.	<ul style="list-style-type: none"> <li>The file extension (.MID, etc.) may have been changed or deleted. Manually rename the file, adding the appropriate extension, on a computer.</li> <li>Data files with names of more than 50 characters cannot be handled by the instrument. Rename the file, reducing the number of characters to 50 or less.</li> </ul>
<b>Voice</b>	
The Voice selected from the Voice Selection display does not sound.	Check whether the selected part is turned on or not (page 38).
A strange “flanging” or “doubling” sound occurs. The sound is slightly different each time the keys are played.	The RIGHT 1 and RIGHT 2 parts are set to “ON,” and both parts are set to play the same Voice. Turn off the RIGHT 2 part or change the Voice of one of the parts.
The sound is slightly different each time the keys are played.	If you are routing the MIDI OUT on the Tyros5 to a sequencer and back to the MIDI IN, you may need to set Local Control setting to “off” in the SYSTEM Page of the MIDI display (refer to the Reference Manual on the website).
Some Voices will jump an octave in pitch when played in the upper or lower registers.	This is normal. Some voices have a pitch limit which, when reached, causes this type of pitch shift.
<b>Style</b>	
The Style does not start even when the [START/STOP] button is pressed.	The Rhythm channel of the selected Style may not contain any data. Turn the [ACMP] button on and play the left-hand section on the keyboard to sound the accompaniment part of the Style.
Only the rhythm channel plays.	<ul style="list-style-type: none"> <li>Make sure the Auto Accompaniment function is turned on; press the [ACMP] button.</li> <li>You may be playing keys in the right hand range of the keyboard. Make sure to play keys in the chord range of the keyboard.</li> </ul>
Styles in a USB flash memory cannot be selected.	If the size of the Style data is large (about 120 KB or greater), the Style cannot be selected because the data is too large to be read by the instrument.
Style playback seems to “skip” when the keyboard is played.	You are probably exceeding the maximum polyphony of the instrument. The instrument can play up to 128 notes at the same time—including RIGHT 1/RIGHT 2/RIGHT 3/LEFT Voices, Style, Song, and Multi Pad notes. When the maximum polyphony is exceeded, the least important notes (such as soft notes and notes currently decaying) will stop sounding first.
Style does not change even when a different chord is played, or the chord is not recognized.	Make sure to play notes on the left-hand section of the keyboard.
The vibrato effect applied when a Style is recorded sounds different when it is played back.	This may occur when you use a Style with certain S.Art2! Voices which have their own default vibrato value. Depending on the Modulation wheel position, the default vibrato value may be recorded or the modulation wheel value may be recorded, regardless of the actual vibrato sound you have played. To remedy this: Before starting to record the Style, operate the Modulation wheel once and change it to the position of the amount of vibrato effect you want to record.
<b>Song</b>	
Songs cannot be selected.	If the size of the Song data is large (about 300 KB or greater), the Song cannot be selected because the data is too large to be read by the instrument.
The sound of a song is too low, or a song cannot be heard.	Check the position of the Cross Fader. If the Cross Fader is set to the right position, you can not hear MIDI song. If this is the case, adjust the Cross Fader to the center position.
Song playback does not start.	The Song has been stopped at the end of the Song data. Return to the beginning of the Song by pressing the SONG [STOP] button.
	<p>In the case of a Song to which write-protect has been applied (“Prot. 2 Edit” is shown at the upper left of the Song name):</p> <ul style="list-style-type: none"> <li>The original file may not be in the same folder. It cannot be played back unless the original file (showing “Prot.2 Orig” at the upper left of the Song name) is in the same folder.</li> <li>The original file name may have been changed. Rename the file with the original file name (so that “Prot.2 Orig” is shown at the upper left of the Song name).</li> <li>The file icon may have been changed. Songs to which write-protect has been applied cannot be played back when the file icon of the original has been changed.</li> </ul>
The measure number is different from that of the score in the Song Position display, shown by pressing the [REW]/[FF] buttons.	This happens when playing back music data for which a specific, fixed tempo is set.



When playing back a Song, some channels do not play.	Playback of these channels may be set to off. <ul style="list-style-type: none"> <li>• Turn playback on for those channels that are set to off on CHANNEL ON/OFF (SONG) (page 75).</li> <li>• Change the SONG CHANNEL setting to “PLAY” via the SETUP window of the Vocal Harmony Type selection display (page 90).</li> </ul>
The tempo, beat, measure and music notation is not displayed correctly.	Some Song data for the instrument has been recorded with special “free tempo” settings. For such Song data, the tempo, beat, measure and music notation will not be displayed correctly.
The vibrato effect applied when a Song is recorded sounds different when it is played back.	This may occur when you use S.Art2! Voices which have their own default vibrato value. Depending on the Modulation wheel position, the default vibrato value may be recorded or the modulation wheel value may be recorded, regardless of the actual vibrato sound you have played. To remedy this: <ul style="list-style-type: none"> <li>• Select a Voice AFTER you set the Modulation wheel to minimum (down) position.</li> <li>• If you want to cancel the vibrato effect, set the Modulation wheel to minimum position AFTER Song recording starts.</li> </ul>
<b>Audio Recorder/Player</b>	
Audio files cannot be selected.	The file format may not be compatible with the instrument. The compatible formats are: MP3 and WAV. DRM protected files cannot be played back.
Recorded file is played back at a different volume compared to when it was recorded.	The audio playback volume has been changed. Setting the volume value to 90 plays back the file at the same volume as when it was recorded (page 61).
An audio song in the internal HDD cannot be copied or cut.	The audio song file name (which contains the file path, internally) in the internal HDD may be too long. Shorten the song name or copy/paste the file to a higher folder level.
In the Audio Recorder/Player function, an error message appears and audio cannot be recorded to the internal hard disk drive.	The data on the hard disk drive is fragmented and cannot be used as is. Since there is no defragmentation function in the Audio Recorder/Player, the drive can only be defragmented by formatting it. To do this, first back up the data to a computer by using the USB storage mode (page 104), then format the drive, and finally copy the data back to the drive (using the USB storage mode again). Performing this copy/restore operation effectively defragments the drive, allowing you to use it again.
<b>Mixing Console</b>	
The sound seems strange or different than expected when changing a rhythm Voice (drum kit, etc.) of the Style or Song from the Mixer.	When changing the rhythm/percussion Voices (drum kits, etc.) of the Style and Song from the VOICE parameter, the detailed settings related to the drum voice are reset, and in some cases you may be unable to restore the original sound. In the case of Song playback, you can restore the original sound by returning to the beginning of the Song and playing back from that point. In the case of Style play, you can restore the original sound by selecting the same Style again.
<b>Microphone/Vocal Harmony</b>	
The microphone input signal cannot be recorded.	The microphone input signal cannot be recorded by Song recording. Use the Audio Recorder/Player function (page 76).
Harmony can be heard in addition to the microphone sound.	Vocal Harmony is set to on. Turn Vocal Harmony off (page 89).
The Vocal Harmony effect sounds distorted or out-of-tune.	Your vocal microphone may be picking up extraneous sounds, such as the Style sound from the instrument. In particular, bass sounds can cause mistracking of the Vocal Harmony. To remedy this: <ul style="list-style-type: none"> <li>• Sing as closely to the microphone as possible.</li> <li>• Use a directional microphone.</li> <li>• Turn down the Master volume, Style volume, or Song volume control (pages 16, 61).</li> <li>• Separate the microphone from the external speakers as far as possible.</li> </ul>
<b>ASSIGNABLE FOOT PEDAL jacks</b>	
The on/off setting of the footswitch connected to the ASSIGNABLE FOOT PEDAL jack is reversed.	Turn the instrument’s power off, then turn it on again making sure not to press the footswitch.
<b>AUX IN jacks</b>	
Sound input to the AUX IN jacks is interrupted.	The output volume of the external device connected to this instrument is too low. Increase the output volume of the external device. The volume level reproduced via this instrument can be adjusted by using the [MASTER VOLUME] control.
<b>USB TO HOST terminal/MIDI terminals</b>	
When connecting the instrument to a computer, the computer freezes.	The generic driver may not be compatible with the instrument. When data communication is unstable or some problem occurs, download the Yamaha Standard USB-MIDI driver from the following URL: <a href="http://download.yamaha.com/">http://download.yamaha.com/</a>

# Specifications

		TYROS5-76	TYROS5-61
<b>Size and Weight</b>	Dimensions [W x D x H] (without Music Rest)	1347 x 450 x 142mm (53-1/16" x 17-11/16" x 5-9/16")	1140 x 450 x 142mm (44-7/8" x 17-11/16" x 5-9/16")
	Weight (without Music Rest)	16.0 kg (35 lbs, 4 oz.)	14.0 kg (30 lbs, 14 oz.)
<b>Interface</b>	Keyboard	Number of Keys	76 (E0–G6)
		Type	Organ (FSX), Initial Touch/Aftertouch
		Touch Response	Hard1, Hard2, Medium, Soft1, Soft2
	Controllers	Pitch Bend Wheel	Yes
		Modulation Wheel	Yes
		Sliders	9 (including 1 assignable)
		Articulation Switches	ART. 1, ART. 2
	Display	Type/Size	640 x 480 dots TFT VGA color 7.5 inch LCD
Language		English, German, French, Spanish, Italian	
Panel	Language	English	
<b>Voices</b>	Tone Generation	Tone Generation Technology	AWM Stereo Sampling
	Polyphony	Number of Polyphony (Max.)	128
	Preset	Number of Voices	1279 Voices + 480 XG Voices + 37 Drum/SFX Kits
		Featured Voices	Ensemble 55 S.Art2! 44 S.Art! 288 MegaVoice 54 Live! 138 Cool! 81 Sweet! 37 Organ World 40
	Expandability	Expansion Voice	Yes *Wave Capacity: depends on the optional Flash Memory Expansion Module (FL1024M, FL512M)
	Compatibility	Part	XG, GS, GM, GM2 Right 1, Right 2, Right 3, Left
<b>Effects</b>	Reverb		52 Presets + 3 User
	Chorus		106 Presets + 3 User
	DSP		DSP1: 322 Presets + 3 User, DSP2-9: 322 Presets + 10 User
	Master Compressor		5 Presets + 5 User settings
	Master EQ		5 Presets + 2 User settings
	Mic Effects		Noise Gate x 1, Compressor x 1, 3Band EQ x 1
	Vocal Harmony	Number of Presets	Vocal Harmony: 44 Synth Vocoder: 10
		Number of User Settings	60 * The number is the total of Vocal Harmony and Synth Vocoder.
Vocal Effect		23	
<b>Styles</b>	Preset	Number of Styles	539
		Featured Styles	40 +Audio, 7 FreePlay, 441 Pro, 51 Session
	Fingering		Single Finger, Fingered, Fingered On Bass, Multi Finger, AI Fingered, Full Keyboard, AI Full Keyboard
	Style Control		INTRO x 3, MAIN VARIATION x 4, FILL x 4, BREAK, ENDING x 3
	Compatibility		Style File Format, Style File Format GE
	Expandability	Expansion Style	Yes
		Expansion Audio Style	Yes Audio Capacity: approx. 124 MB
	Other Features	Music Finder (Max.)	2,500 Records
One Touch Setting (OTS)		4 for each Style	
<b>Songs</b>	Preset	Number of Songs	5 Sample Songs
	Recording	Number of Songs	Unlimited (depends on the drive capacity)
		Number of Tracks	16
		Data Capacity	approx. 300 KB/Song
		Recording Function	Quick Recording, Multi Recording, Step Recording
Data Format	Playback	SMF (Format 0 & 1), XF	
	Recording	SMF (Format 0)	
<b>Multi Pads</b>	Preset	Number of Multi Pad Banks	190 banks x 4 Pads
	Audio	Audio Link	Yes

		TYROS5-76	TYROS5-61
<b>Functions</b>	Voices	Harmony/Echo	Yes
		Panel Sustain	Yes
		Mono/Poly	Yes
		Voice Information	Yes
	Styles	Style Creator	Yes
		Style Recommender	Yes
		OTS Information	Yes
	Songs	Song Creator	Yes
		Score Display Function	Yes
		Lyrics Display Function	Yes
		Text Display Function	Yes
		Wallpaper Customization	Yes
		Lesson/Guide	Follow Lights, Any Key, Karao-Key, Your Tempo
		Performance Assistant Technology (P.A.T.)	Yes
	Multi Pads	Multi Pad Creator	Yes
	Registration Memory	Number of Buttons	8
		Control	Registration Sequence, Freeze
	Audio Recorder/ Player	Recording Time (max.)	80 minutes/Song
		Recording	.wav (WAV format: 44.1 kHz sample rate, 16 bit resolution, stereo)
		Playback	.wav (WAV format: 44.1 kHz sample rate, 16 bit resolution, stereo) .mp3 (MPEG-1 Audio Layer-3: 44.1/48.0 kHz sample rate, 64–320 kbps and variable bit rate, mono/stereo)
		Time Stretch	Yes
		Pitch Shift	Yes
		Vocal Cancel	Yes
		Multi	Recording
	Playback		.aud (Tyros5 original: 44.1 kHz sample rate, 16 bit resolution, stereo)
	Demo/Help	Demonstration	Yes
	Overall Controls	Metronome	Yes
Tempo		5 – 500, Tap Tempo	
Transpose		-12 – 0 – +12	
Tuning		414.8 – 440 – 466.8 Hz	
Octave Button		Yes	
Miscellaneous	Scale Type	9 Presets	
	Direct Access	Yes	
<b>Storage</b>	Internal Memory (USER Drive)	approx. 6.7 MB	
	Internal Hard Disk	500 GB	
	External Drives	USB Flash Memory (via USB to DEVICE)	
<b>Connections</b>	Headphones	Yes	
	Microphone	Yes (Combo Jack)	
	MIDI	MIDI A (IN/OUT), MIDI B (IN/OUT)	
	AUX IN	L/L+R, R	
	LINE OUT	MAIN (L/L+R, R), SUB OUT (1,2), SUB OUT (3,4 / AUX OUT)	
	RGB OUT	Yes	
	FOOT PEDAL	1 (SUSTAIN), 2 (ARTICULATION 1), 3 (VOLUME), Function Assignable	
	USB TO DEVICE	USB 2.0 x 2 (Front/Back)	
<b>Pedals</b>	USB TO HOST	USB 2.0 x 1	
	Assignable Functions	Volume, Sustain, Sostenuto, Soft, Glide, S. Articulation, Song Play/Pause, Style Start/Stop, etc.	
<b>Included Accessories</b>		<ul style="list-style-type: none"> <li>• Owner's Manual (this book)</li> <li>• Online Member Product Registration</li> <li>• AC Power Cord</li> <li>• Music Rest, two Music Rest Brackets</li> <li>• USB Wireless LAN Adaptor</li> </ul> <p>* May not be included depending on your particular area. Please check with your Yamaha dealer.</p>	
<b>Optional Accessories</b>		<ul style="list-style-type: none"> <li>• Option Speaker: TRS-MS05</li> <li>• Headphones: HPE-150, HPE-170</li> <li>• Footswitch: FC4, FC5</li> <li>• Foot Controller: FC7</li> <li>• MIDI Foot Controller: MFC10</li> <li>• Flash Memory Expansion Module: FL1024M, FL512M</li> <li>• Keyboard Stand: L-7S</li> </ul> <p>* The exterior size of the Tyros5-76 is beyond the limits as described in the L-7S Assembly Instructions. However, we have determined through tests that the stand can be safely used for the instrument.</p> <ul style="list-style-type: none"> <li>• MIDI Interface for iPhone/iPod touch/iPad: i-MX1</li> <li>• USB MIDI Interface for iPhone/iPod touch/iPad: i-UX1</li> </ul>	

\* Specifications and descriptions in this owner's manual are for information purposes only. Yamaha Corp. reserves the right to change or modify products or specifications at any time without prior notice. Since specifications, equipment or options may not be the same in every locale, please check with your Yamaha dealer.

# Index

## A

A-B Repeat .....	80
AC IN.....	16
Accessories.....	9
AI Full Keyboard .....	55
ART. 1 .....	100
Articulation Effect.....	40
ASSIGN slider function .....	25
Audio connection .....	97
Audio file.....	76
Audio File Selection display.....	78
Audio Link .....	66
Audio Player.....	76
Audio Recorder.....	76
Audio Song information.....	24
Audio Style.....	52
Audio Volume .....	80
Auto Accompaniment .....	51
Auto Fill .....	54
Auto Power Off .....	17
AUX IN .....	97

## B

Backup .....	35
Bar .....	24
Beat .....	24
Break.....	54

## C

Channel .....	25
Channel (Song) .....	75
Channel (Style).....	60
Character entry.....	34
Chord .....	24, 55
Chord Fingering Type .....	55
Chord Match.....	65
Chordal.....	89
Clock .....	25
CMP .....	93
Computer .....	103–104
Computer-related Operations .....	10
Concert (Organ World) .....	42
CONFIG1.....	96
CONFIG2.....	96
Connection.....	97
Copy.....	32
Cross Fader .....	79
Cut.....	32

## D

Data List .....	10
Delete.....	33
Demo .....	17
Direct Access .....	23
Direct Access Chart .....	110
Display .....	18, 20, 24
Drum Voice .....	39
DSP .....	48

## E

Echo.....	48–49
EFFECT .....	93
Effect.....	48
Ending section.....	53
Ensemble Voice.....	44
EQ .....	93
Euro (Organ World).....	42
Exit.....	22
Expansion Pack.....	50

## F

Factory Reset.....	35
Fade In/Out.....	54
Fast Forward.....	72
Favorite (Voice) .....	37
FILE ACCESS.....	28
File Management .....	29
File Selection Display .....	25, 27
FILTER.....	93
FL1024M .....	108
FL512M .....	108
Folder.....	26, 30
Foot Controller.....	100
Footswitch .....	100
Format.....	102

## H

Harmony.....	48–49
HD .....	25
headphones .....	15
Home (Organ World).....	42

## I

Initial Touch .....	48
Intro section .....	53
iPhone/iPad .....	102
iPhone/iPad Connection Manual....	10

## K

Keyboard Parts .....	38
----------------------	----

## L

Lamp (USB READ/WRITE).....	25
Language .....	18
Layer.....	37
LCD .....	20
Left Hold.....	39
LINE OUT.....	93, 97
List View.....	27
Loop Playback .....	75
Lyrics .....	73

## M

Main Display .....	24
Main section.....	54
Master Compressor .....	94
MEDIA .....	96
Memory (Song/Style paths).....	28
MENU 1/MENU 2 .....	26
Message.....	23
MIC Input level indicator .....	24
Microphone.....	88, 97
MIDI.....	102, 105
Mixing Console.....	92
Modulation Wheel.....	47
Monitor .....	99
Mono.....	48
Move.....	32
MP3 .....	78
Multi Pad .....	64
Multi Pad Bank name .....	24
Multi Track Recording .....	69
Music Finder .....	81
Music Rest.....	14
Mute.....	80

## N

Normal View .....	27
-------------------	----

## O

One Touch Setting.....	56
Optional Accessories .....	119
Optional Flash Memory .....	108
Optional Speakers .....	106
Organ World .....	42
OWNER .....	96

## P

Panel Button Chart.....	112
Panel Control.....	12
Panel Lock .....	19
Pause .....	72
Pitch.....	46
Pitch Bend Wheel .....	47
Pitch Shift.....	80
Playback (Audio File).....	78
Playback (Song) .....	71
Playback (Style).....	53
Power .....	16
PRESET .....	25
Preset Voice.....	36
Protect Song .....	29

## R

Recording .....	68
Recording (Audio) .....	76
Reference Manual.....	10
Registration Memory .....	85
Registration Memory Bank name ...	24
Registration Sequence .....	25
Rename .....	31
Repertoire .....	57
Restore.....	35
Rewind .....	72
RGB OUT .....	99

## S

S.Art!/S.Art2! .....	39–40
Save.....	29, 86
Score.....	73
Search (Music Finder) .....	83
Section (Style) .....	53
SFX Voice .....	39
Single Finger .....	55
Song.....	68
Song name.....	24
Song Position Marker .....	74
Song Selection display .....	71
Specifications .....	118
Split.....	38
Split Point.....	62
Style.....	51
Style file compatibility .....	52
Style name .....	24
Style Recommender.....	58
Style Selection display.....	51
Super Articulation Voice.....	40
SUSTAIN .....	100
Sustain .....	48
Synchro Start (Multi Pad) .....	65
Synchro Start (Song) .....	72
Synchro Start (Style) .....	53
Synchro Stop.....	53
Synth Vocoder.....	91
SYSTEM RESET .....	96

## T

Tab .....	21
Talk.....	90
Tap .....	54
Tempo .....	24, 54
Terminal .....	12
Text.....	73
Theatre (Organ World) .....	42
Time Stretch.....	80
Transpose.....	25, 46
Troubleshooting.....	115
TRS-MS05 .....	97, 106
TUNE .....	93
Tuning .....	46

## U

Upper Octave .....	25
USB .....	25
USB Device .....	101
USB flash memory .....	101
USB Wireless LAN Adaptor Manual .....	10
USER .....	25
Utility .....	96

## V

Version .....	19
Vintage (Organ World).....	42
Vocal Cancel.....	80
Vocal Harmony.....	89
Vocal Harmony Type.....	25
Vocoder.....	89
Vocoder-Mono.....	89
Voice.....	36
Voice name .....	24
VOL/VOICE .....	93
Volume .....	16
Volume Balance .....	25, 61
Volume Balance (MIDI Song and Audio file) .....	79

## W

WAV.....	78
----------	----

**MEMO**

**MEMO**

## Important Notice: Guarantee Information for customers in European Economic Area (EEA) and Switzerland

<b>English</b>	<b>Important Notice: Guarantee information for customers in EEA* and Switzerland</b> For detailed guarantee information about this Yamaha product, and Pan-EEA* and Switzerland warranty service, please either visit the website address below (Printable file is available at our website) or contact the Yamaha representative office for your country. * EEA: European Economic Area
<b>Deutsch</b>	<b>Wichtiger Hinweis: Garantie-Information für Kunden in der EWR* und der Schweiz</b> Für nähere Garantie-Information über dieses Produkt von Yamaha, sowie über den Pan-EWR*- und Schweizer Garantieservice, besuchen Sie bitte entweder die folgende angegebene Internetadresse (eine druckfähige Version befindet sich auch auf unserer Webseite), oder wenden Sie sich an den für Ihr Land zuständigen Yamaha-Vertrieb. *EWR: Europäischer Wirtschaftsraum
<b>Français</b>	<b>Remarque importante: informations de garantie pour les clients de l'EEE* et la Suisse</b> Pour des informations plus détaillées sur la garantie de ce produit Yamaha et sur le service de garantie applicable dans l'ensemble de l'EEE ainsi qu'en Suisse, consultez notre site Web à l'adresse ci-dessous (le fichier imprimable est disponible sur notre site Web) ou contactez directement Yamaha dans votre pays de résidence. * EEE : Espace Economique Européen
<b>Nederlands</b>	<b>Belangrijke mededeling: Garantie-informatie voor klanten in de EER* en Zwitserland</b> Voor gedetailleerde informatie over dit Yamaha-product en de garantieservice in heel de EER* en Zwitserland, gaat u naar de onderstaande website (u vind een afdrukbaar bestand op onze website) of neemt u contact op met de vertegenwoordiging van Yamaha in uw land. * EER: Europese Economische Ruimte
<b>Español</b>	<b>Aviso importante: información sobre la garantía para los clientes del EEE* y Suiza</b> Para una información detallada sobre este producto Yamaha y sobre el soporte de garantía en la zona EEE* y Suiza, visite la dirección web que se incluye más abajo (la versión del archivo para imprimir está disponible en nuestro sitio web) o póngase en contacto con el representante de Yamaha en su país. * EEE: Espacio Económico Europeo
<b>Italiano</b>	<b>Aviso importante: informazioni sulla garanzia per i clienti residenti nell'EEA* e in Svizzera</b> Per informazioni dettagliate sulla garanzia relativa a questo prodotto Yamaha e l'assistenza in garanzia nei paesi EEA* e in Svizzera, potete consultare il sito Web all'indirizzo riportato di seguito (è disponibile il file in formato stampabile) oppure contattate l'ufficio di rappresentanza locale della Yamaha. * EEA: Area Economica Europea
<b>Português</b>	<b>Aviso importante: informações sobre as garantias para clientes da AEE* e da Suíça</b> Para obter uma informação pormenorizada sobre este produto da Yamaha e sobre o serviço de garantia na AEE* e na Suíça, visite o site a seguir (o arquivo para impressão está disponível no nosso site) ou entre em contato com o escritório de representação da Yamaha no seu país. * AEE: Área Económica Europeia
<b>Ελληνικά</b>	<b>Σημαντική σημείωση: Πληροφορίες εγγύησης για τους πελάτες στον ΕΟΧ* και Ελβετία</b> Για λεπτομερείς πληροφορίες εγγύησης σχετικά με το παρόν προϊόν της Yamaha και την κάλυψη εγγύησης σε όλες τις χώρες του ΕΟΧ και την Ελβετία, επισκεφτείτε την παρακάτω ιστοσελίδα (Εκτυρίσιμη μορφή είναι διαθέσιμη στην ιστοσελίδα μας) ή απευθυνθείτε στην αντιπροσωπεία της Yamaha στη χώρα σας. * ΕΟΧ: Ευρωπαϊκός Οικονομικός Χώρος
<b>Svenska</b>	<b>Viktigt: Garantierinformation för kunder i EES-området* och Schweiz</b> För detaljerad information om denna Yamaha-produkt och garantier i hela EES-området* och Schweiz kan du antingen besöka nedanstående webbadress (en utskriftsvänlig fil finns på webbplatsen) eller kontakta Yamahas officiella representant i ditt land. * EES: Europeiska Ekonomiska Samarbetsområdet
<b>Norsk</b>	<b>Viktig merknad: Garantiinformasjon for kunder i EØS* og Sveits</b> Detaljert garantiinformasjon om dette Yamaha-produktet og garantier i hele EØS-området* og Sveits kan fås enten ved å besøke nettstedene nedenfor (utskriftsversjon finnes på våre nettsider) eller kontakte kontaktene i landet der du bor. *EØS: Europeiske økonomiske samarbeidsområder
<b>Dansk</b>	<b>Vigtig oplysning: Garantioplysninger til kunder i EØO* og Schweiz</b> De kan finde detaljerede garantioplysninger om dette Yamaha-produkt og den fælles garantierne i EØO* (og Schweiz) ved at besøge det websted, der er angivet nedenfor (der findes en fil, som kan udskrives, på vores websted), eller ved at kontakte Yamahas nationale repræsentationskontor i det land, hvor De bor. * EØO: Det Europæiske Økonomiske Område

<b>Suomi</b>	<b>Tärkeä ilmoitus: Takuutiedot Euroopan talousalueen (ETA)* ja Sveitsin asiakkaille</b> Tämän Yamaha-luotteen sekä ETA-alueen ja Sveitsin takuuta koskevat yksityiskohtaiset tiedot saatte alla olevasta nettosoitteesta. (Tulostettava tiedosto saatavissa sivustollamme.) Voitte myös ottaa yhteyttä paikalliseen Yamaha-edustajaan. *ETA: Euroopan talousalue
<b>Polski</b>	<b>Ważne: Warunki gwarancyjne obowiązujące w EOG* i Szwajcarii</b> Aby dowiedzieć się więcej na temat warunków gwarancyjnych tego produktu firmy Yamaha i serwisu gwarancyjnego w całym EOG* i Szwajcarii, należy odwiedzić wskazaną poniżej stronę internetową (Plik gotowy do wydruku znajduje się na naszej stronie internetowej) lub skontaktować się z przedstawicielem firmy Yamaha w swoim kraju. * EOG — Europejski Obszar Gospodarczy
<b>Česky</b>	<b>Důležité oznámení: Zásadní informace pro zákazníky v EHS* a ve Švýcarsku</b> Podrobné zásadní informace o tomto produktu Yamaha a záručním servisu v celém EHS* a ve Švýcarsku naleznete na níže uvedené webové adrese (soubor k tisku je dostupný na našich webových stránkách) nebo se můžete obrátit na zástupce firmy Yamaha ve své zemi. * EHS: Evropský hospodářský prostor
<b>Magyar</b>	<b>Fontos figyelmeztetés: Garancia-információk az EGT* területén és Svájcban élő vásárlók számára</b> A jelen Yamaha termékre vonatkozó részletes garancia-információk, valamint az EGT*-re és Svájcra kiterjedő garanciális szolgáltatás tekintetében keressék fel webhelyünket az alábbi címen (a webhelyen nyomtatható fájljt is talál), vagy pedig lépjen kapcsolatba az országában működő Yamaha képviselői iróddal. * EGT: Európai Gazdasági Térség
<b>Eesti keel</b>	<b>Ouline märkus: Garantiiteave Euroopa Majanduspiirkonna (EMP)* ja Šveitsi klientidele</b> Täpsem teabe saamiseks selle Yamaha toote garantii ning kogu Euroopa Majanduspiirkonna ja Šveitsi garantiiteeninduse kohta, külastage palun veebisaiti alljärgneval aadressil (meie saidil on saadaval printitav fail) või pöörduge Teie riigis Yamaha esinduse poole. * EMP: Euroopa Majanduspiirkond
<b>Latviešu</b>	<b>Svarīgs paziņojums: garantijas informācija klientiem EEZ* un Šveicē</b> Lai saņemtu detaļizētā garantijas informāciju par šo Yamaha produktu, kā arī garantijas apkalpošanu EEZ* un Šveicē, lūdzam apmeklēt vietni, kur norādīts tīmekļa vietnes adresi (tīmekļa vietni ir pieejams drukājams fails) vai sazināties ar jūsu valsti apkalpojošo Yamaha pārstāvniecību. * EEZ: Eiropas Ekonomikas zona
<b>Lietuvių kalba</b>	<b>Dėmesio: informacija dėl garantijos pirkėjams EEE* ir Šveicarijoje</b> Jei reikia išsames informacijos apie šį „Yamaha“ produktą ir jo techninę priežiūrą visoje EEE* ir Šveicarijoje, apsilankykite mūsų svetainėje toliau nurodytu adresu (svetainėje yra spausdinamas failas) arba kreipkitės į „Yamaha“ atstovybę savo šaliai. *EEE – Europos ekonominė erdvė
<b>Slovenčina</b>	<b>Dôležité upozornenie: Informácie o záruke pre zákazníkov v EHP* a Švajčiarsku</b> Podrobne informácie o záruke týkajúce sa tohto produktu od spoločnosti Yamaha a garančnom servise v EHP* a Švajčiarsku nájdete na webovej stránke uvedenej nižšie (na našej webovej stránke je k dispozícii súbor na tlač) alebo sa obráťte na zástupcu spoločnosti Yamaha vo svojej krajine. * EHP: Európsky hospodársky priestor
<b>Slovenshina</b>	<b>Pomembno obvestilo: Informacije o garanciji za kupce v EGP* in Švici</b> Za podrobnejše informacije o tem Yamahinem izdelku ter garancijskem servisu v celotnem EGP in Švici, obiščite spletno mesto, ki je navedeno spodaj (natisljiva datoteka je na voljo na našem spletnem mestu), ali se obrnite na Yamahinega predstavnika v svoji državi. * EGP: Evropski gospodarski prostor
<b>Български език</b>	<b>Важно съобщение: Информация за гаранцията за клиенти в ЕМП* и Швейцария</b> За подробна информация за гаранцията за този продукт на Yamaha и гаранционното обслужване в паневропейската зона на ЕМП* и Швейцария или посетете посочения по-долу уеб сайт (на нашия уеб сайт има файл за печат), или се свържете с представителния офис на Yamaha във вашата страна. * ЕМП: Европейско икономическо пространство
<b>Limba română</b>	<b>Notificarea importantă: Informații despre garanție pentru clienții din SEE* și Elveția</b> Pentru informații detaliate privind acest produs Yamaha și serviciul de garanție Pan-SEE* și Elveția, vizitați site-ul la adresa de mai jos (fișierul imprimabil este disponibil pe site-ul nostru) sau contactați biroul reprezentanței Yamaha din țara dumneavoastră. * SEE: Spațiul Economic European

<http://europe.yamaha.com/warranty/>





## 1-YEAR LIMITED WARRANTY ON ARRANGER WORKSTATION KEYBOARDS

Thank you for selecting a YAMAHA product. YAMAHA products are designed and manufactured to provide a high level of defect-free performance. Yamaha Corporation of America ("YAMAHA") is proud of the experience and craftsmanship that goes into each and every YAMAHA product. YAMAHA sells its products through a network of reputable, specially authorized dealers and is pleased to offer you, the Original Owner, the following Limited Warranty, which applies only to products that have been (1) directly purchased from YAMAHA's authorized dealers in the fifty states of the USA and District of Columbia (the "Warranted Area") and (2) used exclusively in the Warranted Area. YAMAHA suggests that you read the Limited Warranty thoroughly, and invites you to contact your authorized YAMAHA dealer or YAMAHA Customer Service if you have any questions.

**Coverage:** YAMAHA will, at its option, repair or replace the product covered by this warranty if it becomes defective, malfunctions or otherwise fails to conform with this warranty under normal use and service during the term of this warranty, without charge for labor or materials. Repairs may be performed using new or refurbished parts that meet or exceed YAMAHA specifications for new parts. If YAMAHA elects to replace the product, the replacement may be a reconditioned unit. You will be responsible for any installation or removal charges and for any initial shipping charges if the product(s) must be shipped for warranty service. However, YAMAHA will pay the return shipping charges to any destination within the USA if the repairs are covered by the warranty. This warranty does not cover (a) damage, deterioration or malfunction resulting from accident, negligence, misuse, abuse, improper installation or operation or failure to follow instructions according to the Owner's Manual for this product; any shipment of the product (claims must be presented to the carrier); repair or attempted repair by anyone other than YAMAHA or an authorized YAMAHA Service Center; (b) any unit which has been altered or on which the serial number has been defaced, modified or removed; (c) normal wear and any periodic maintenance; (d) deterioration due to perspiration, corrosive atmosphere or other external causes such as extremes in temperature or humidity; (e) damages attributable to power line surge or related electrical abnormalities, lightning damage or acts of God; or (f) RFI/EMI (Interference/noise) caused by improper grounding or the improper use of either certified or uncertified equipment, if applicable. Any evidence of alteration, erasing or forgery of proof-of-purchase documents will cause this warranty to be void. This warranty covers only the Original Owner and is not transferable.

**In Order to Obtain Warranty Service:** Warranty service will only be provided for defective products within the Warranted Area. Contact your local authorized YAMAHA dealer who will advise you of the procedures to be followed. If this is not successful, contact YAMAHA at the address, telephone number or website shown below. YAMAHA may request that you send the defective product to a local authorized YAMAHA Servicer or authorize return of the defective product to YAMAHA for repair. If you are uncertain as to whether a dealer has been authorized by YAMAHA, please contact YAMAHA's Service Department at the number shown below, or check Yamaha's website at [www.Yamaha.com](http://www.Yamaha.com). Product(s) shipped for service should be packed securely and must be accompanied by a detailed explanation of the problem(s) requiring service, together with the original or a machine reproduction of the bill of sale or other dated, proof-of-purchase document describing the product, as evidence of warranty coverage. Should any product submitted for warranty service be found ineligible therefore, an estimate of repair cost will be furnished and the repair will be accomplished only if requested by you and upon receipt of payment or acceptable arrangement for payment.

**Limitation of Implied Warranties and Exclusion of Damages:** ANY IMPLIED WARRANTIES, INCLUDING WARRANTIES OF MERCHANTABILITY AND FITNESS FOR A PARTICULAR PURPOSE SHALL BE LIMITED IN DURATION TO THE APPLICABLE PERIOD OF TIME SET FORTH ABOVE. YAMAHA SHALL NOT BE RESPONSIBLE FOR INCIDENTAL OR CONSEQUENTIAL DAMAGES OR FOR DAMAGES BASED UPON INCONVENIENCE, LOSS OF USE, DAMAGE TO ANY OTHER EQUIPMENT OR OTHER ITEMS AT THE SITE OF USE OR INTERRUPTION OF PERFORMANCES OR ANY CONSEQUENCES. YAMAHA'S LIABILITY FOR ANY DEFECTIVE PRODUCT IS LIMITED TO REPAIR OR REPLACEMENT OF THE PRODUCT, AT YAMAHA'S OPTION. SOME STATES DO NOT ALLOW LIMITATIONS ON HOW LONG AN IMPLIED WARRANTY LASTS OR THE EXCLUSION OR LIMITATION OF INCIDENTAL OR CONSEQUENTIAL DAMAGES, SO THE ABOVE LIMITATION OR EXCLUSION MAY NOT APPLY TO YOU. This Warranty gives you specific legal rights, and you may also have other rights which vary from state to state. This is the only express warranty applicable to the product specified herein; Yamaha neither assumes nor authorizes anyone to assume for it any other express warranty.

If you have any questions about service received or if you need assistance in locating an authorized YAMAHA Servicer, please contact:



CUSTOMER SERVICE  
Yamaha Corporation of America  
6600 Orangethorpe Avenue, Buena Park, California 90620-1373  
Telephone: 800-854-1569  
[www.yamaha.com](http://www.yamaha.com)

**Do not return any product to the above address without a written Return Authorization issued by YAMAHA.**

©2009 Yamaha Corporation of America. Printed in U.S.A.

# FCC INFORMATION (U.S.A.)

## 1. IMPORTANT NOTICE: DO NOT MODIFY THIS UNIT!

This product, when installed as indicated in the instructions contained in this manual, meets FCC requirements. Modifications not expressly approved by Yamaha may void your authority, granted by the FCC, to use the product.

**2. IMPORTANT:** When connecting this product to accessories and/or another product use only high quality shielded cables. Cable/s supplied with this product MUST be used. Follow all installation instructions. Failure to follow instructions could void your FCC authorization to use this product in the USA.

**3. NOTE:** This product has been tested and found to comply with the requirements listed in FCC Regulations, Part 15 for Class "B" digital devices. Compliance with these requirements provides a reasonable level of assurance that your use of this product in a residential environment will not result in harmful interference with other electronic devices. This equipment generates/uses radio frequencies and, if not installed and used according to the instructions found in the users manual, may cause interference harmful to the operation of other electronic devices. Compliance with FCC regulations does

not guarantee that interference will not occur in all installations. If this product is found to be the source of interference, which can be determined by turning the unit "OFF" and "ON", please try to eliminate the problem by using one of the following measures:

Relocate either this product or the device that is being affected by the interference.

Utilize power outlets that are on different branch (circuit breaker or fuse) circuits or install AC line filter/s.

In the case of radio or TV interference, relocate/reorient the antenna. If the antenna lead-in is 300 ohm ribbon lead, change the lead-in to co-axial type cable.

If these corrective measures do not produce satisfactory results, please contact the local retailer authorized to distribute this type of product. If you can not locate the appropriate retailer, please contact Yamaha Corporation of America, Electronic Service Division, 6600 Orangethorpe Ave, Buena Park, CA90620

The above statements apply ONLY to those products distributed by Yamaha Corporation of America or its subsidiaries.

\* This applies only to products distributed by YAMAHA CORPORATION OF AMERICA.

(class B)

## IMPORTANT NOTICE FOR THE UNITED KINGDOM Connecting the Plug and Cord

**WARNING:** THIS APPARATUS MUST BE EARTHED IMPORTANT. The wires in this mains lead are coloured in accordance with the following code:

GREEN-AND-YELLOW : EARTH  
BLUE : NEUTRAL  
BROWN : LIVE

As the colours of the wires in the mains lead of this apparatus may not correspond with the coloured markings identifying the terminals in your plug proceed as follows:

The wire which is coloured GREEN-and-YELLOW must be connected to the terminal in the plug which is marked by the letter E or by the safety earth symbol  or colored GREEN or GREEN-and-YELLOW.

The wire which is coloured BLUE must be connected to the terminal which is marked with the letter N or coloured BLACK.

The wire which is coloured BROWN must be connected to the terminal which is marked with the letter L or coloured RED.

(3 wires)

## COMPLIANCE INFORMATION STATEMENT (DECLARATION OF CONFORMITY PROCEDURE)

Responsible Party : Yamaha Corporation of America  
Address : 6600 Orangethorpe Ave., Buena Park, Calif.  
90620

Telephone : 714-522-9011

Type of Equipment : DIGITAL KEYBOARD

Model Name : TYROS5-76/TYROS5-61

This device complies with Part 15 of the FCC Rules.

Operation is subject to the following two conditions:

- 1) this device may not cause harmful interference, and
- 2) this device must accept any interference received including interference that may cause undesired operation.

See user manual instructions if interference to radio reception is suspected.

\* This applies only to products distributed by  
YAMAHA CORPORATION OF AMERICA.

(FCC DoC)

## Information for Users on Collection and Disposal of Old Equipment



This symbol on the products, packaging, and/or accompanying documents means that used electrical and electronic products should not be mixed with general household waste.

For proper treatment, recovery and recycling of old products, please take them to applicable collection points, in accordance with your national legislation and the Directives 2002/96/EC.

By disposing of these products correctly, you will help to save valuable resources and prevent any potential negative effects on human health and the environment which could otherwise arise from inappropriate waste handling.

For more information about collection and recycling of old products, please contact your local municipality, your waste disposal service or the point of sale where you purchased the items.

### [For business users in the European Union]

If you wish to discard electrical and electronic equipment, please contact your dealer or supplier for further information.

### [Information on Disposal in other Countries outside the European Union]

This symbol is only valid in the European Union. If you wish to discard these items, please contact your local authorities or dealer and ask for the correct method of disposal.

(weee\_eu\_en\_01)

For details of products, please contact your nearest Yamaha representative or the authorized distributor listed below.

Pour plus de détails sur les produits, veuillez-vous adresser à Yamaha ou au distributeur le plus proche de vous figurant dans la liste suivante.

Die Einzelheiten zu Produkten sind bei Ihrer unten aufgeführten Niederlassung und bei Yamaha Vertragshändlern in den jeweiligen Bestimmungsländern erhältlich.

Para detalles sobre productos, contacte su tienda Yamaha más cercana o el distribuidor autorizado que se lista debajo.

## NORTH AMERICA

### CANADA

**Yamaha Canada Music Ltd.**  
135 Milner Avenue, Toronto, Ontario,  
M1S 3R1, Canada  
Tel: 416-298-1311

### U.S.A.

**Yamaha Corporation of America**  
6600 Orangethorpe Avenue, Buena Park, CA 90620,  
U.S.A.  
Tel: 714-522-9011

## CENTRAL & SOUTH AMERICA

### MEXICO

**Yamaha de México, S.A. de C.V.**  
Av. Insurgentes Sur 1647 "Prisma Insurgentes",  
Col. San Jose Insurgentes, Del. Benito Juarez,  
03900, Mexico, D.F.  
Tel: 55-5804-0600

### BRAZIL

**Yamaha Musical do Brasil Ltda.**  
Rua Joaquim Floriano, 913 - 4º andar, Itaim Bibi,  
CEP 04534-013 São Paulo, SP, BRAZIL  
Tel: 011-3704-1377

### ARGENTINA

**Yamaha Music Latin America, S.A.,  
Sucursal Argentina**  
Olga Cossetini 1553, Piso 4 Norte,  
Madero Este-C1107CEK  
Buenos Aires, Argentina  
Tel: 54-11-4119-7000

### VENEZUELA

**Yamaha Music Latin America, S.A.,  
Sucursal Venezuela**  
C.C. Manzanera Plaza P4  
Ofic. 0401- Manzanera-Baruta  
Caracas Venezuela  
Tel: 58-212-943-1877

### PANAMA AND OTHER LATIN AMERICAN COUNTRIES/ CARIBBEAN COUNTRIES

**Yamaha Music Latin America, S.A.**  
Torre Banco General, Piso No.7, Marbella,  
Calle 47 y Aquilino de la Guardia,  
Ciudad de Panamá, República de Panamá  
Tel: +507-269-5311

## EUROPE

### THE UNITED KINGDOM/IRELAND

**Yamaha Music Europe GmbH (UK)**  
Sherbourne Drive, Tilbrook, Milton Keynes,  
MK7 8BL, U.K.  
Tel: 01908-366700

### GERMANY

**Yamaha Music Europe GmbH**  
Siemensstraße 22-34, 25462 Rellingen, Germany  
Tel: 04101-3030

### SWITZERLAND/LIECHTENSTEIN

**Yamaha Music Europe GmbH  
Branch Switzerland in Zürich**  
Seefeldstrasse 94, 8008 Zürich, Switzerland  
Tel: 044-387-8080

### AUSTRIA

**Yamaha Music Europe GmbH Branch Austria**  
Schleiergasse 20, A-1100 Wien, Austria  
Tel: 01-60203900

### CZECH REPUBLIC/HUNGARY/ ROMANIA/SLOVAKIA/SLOVENIA

**Yamaha Music Europe GmbH  
Branch Austria (Central Eastern Europe Office)**  
Schleiergasse 20, A-1100 Wien, Austria  
Tel: 01-60203900

### POLAND/LITHUANIA/LATVIA/ESTONIA

**Yamaha Music Europe GmbH  
Branch Poland Office**  
ul. Wrotkowa 14 02-553 Warsaw, Poland  
Tel: 022-500-2925

### BULGARIA

**Dinacord Bulgaria LTD.**  
Bul. Iskarsko Schose 7 Targowski Zentar Ewropa  
1528 Sofia, Bulgaria  
Tel: 02-978-20-25

### MALTA

**Olimpus Music Ltd.**  
The Emporium, Level 3, St. Louis Street Msida  
MSD06  
Tel: 02133-2144

### NETHERLANDS/BELGIUM/ LUXEMBOURG

**Yamaha Music Europe Branch Benelux**  
Clarissenhof 5-b, 4133 AB Vianen, Netherlands  
Tel: 0347-358 040

### FRANCE

**Yamaha Music Europe**  
7 rue Ambroise Croizat, Zone d'activites Pariest,  
77183 Croissy-Beaubourg, France  
Tel: 01-64-61-4000

### ITALY

**Yamaha Music Europe GmbH, Branch Italy**  
Viale Italia 88, 20020 Lainate (Milano), Italy  
Tel: 02-935-771

### SPAIN/PORTUGAL

**Yamaha Music Europe GmbH Ibérica, Sucursal  
en España**  
Ctra. de la Coruna km. 17,200, 28231  
Las Rozas (Madrid), Spain  
Tel: +34-91-639-88-88

### GREECE

**Philippos Nakas S.A. The Music House**  
147 Skiathou Street, 112-55 Athens, Greece  
Tel: 01-228 2160

### SWEDEN

**Yamaha Music Europe GmbH Germany filial  
Scandinavia**  
J. A. Wettergrensgata 1, Box 30053  
S-400 43 Göteborg, Sweden  
Tel: +46 31 89 34 00

### DENMARK

**Yamaha Music Europe GmbH, Tyskland – filial  
Denmark**  
Generatorvej 6A, DK-2730 Herlev, Denmark  
Tel: 44 92 40 00

### FINLAND

**F-Musiikki Oy**  
Kluuvikatu 6, P.O. Box 260,  
SF-00101 Helsinki, Finland  
Tel: 09 618511

### NORWAY

**Yamaha Music Europe GmbH Germany -  
Norwegian Branch**  
Grini Næringspark 1, N-1361 Østerås, Norway  
Tel: 67 16 78 00

### ICELAND

**Skifan HF**  
Skeifan 17 P.O. Box 8120, IS-128 Reykjavik, Ice-  
land  
Tel: 525 5000

### RUSSIA

**Yamaha Music (Russia) LLC.**  
Room 37, bld. 7, Kievskaya street, Moscow,  
121059, Russia  
Tel: 495 626 5005

### OTHER EUROPEAN COUNTRIES

**Yamaha Music Europe GmbH**  
Siemensstraße 22-34, 25462 Rellingen, Germany  
Tel: +49-4101-3030

## AFRICA

### SOUTH AFRICA

**Global Music Instruments**  
Unit 4, 130 Boeing Road East Bedfordview 2008  
Postnet Suite 130, Private Bag X10020 Edenvale  
1610, South Africa  
Tel: 27-11-454-1131

### OTHER AFRICAN COUNTRIES

**Yamaha Music Gulf FZE**  
LOB 16-513, P.O.Box 17328, Jebel Ali,  
Dubai, United Arab Emirates  
Tel: +971-4-881-5868

## MIDDLE EAST

### TURKEY/CYPRUS

**Yamaha Music Europe GmbH**  
Merkezi Almanya Türkiye İstanbul Şubesi  
Maslak Meydan Sokak No:5 Spring Giz Plaza  
Bağımsız Böl. No:3, 34398 Şişli, İstanbul  
Tel: +90-212-999-8010

### OTHER COUNTRIES

**Yamaha Music Gulf FZE**  
LOB 16-513, P.O.Box 17328, Jebel Ali,  
Dubai, United Arab Emirates  
Tel: +971-4-881-5868

## ASIA

### THE PEOPLE'S REPUBLIC OF CHINA

**Yamaha Music & Electronics (China) Co.,Ltd.**  
2F, Yunhedasha, 1818 Xinzha-lu, Jingan-qu,  
Shanghai, China  
Tel: 021-6247-2211

### HONG KONG

**Tom Lee Music Co., Ltd.**  
11/F., Silvercord Tower 1, 30 Canton Road,  
Tsimshatsui, Kowloon, Hong Kong  
Tel: 2737-7688

### INDIA

**Yamaha Music India Pvt. Ltd.**  
Spazedge building, Ground Floor, Tower A, Sector  
47, Gurgaon- Sohna Road, Gurgaon, Haryana, India  
Tel: 0124-485-3300

### INDONESIA

**PT. Yamaha Musik Indonesia (Distributor)**  
Yamaha Music Center Bldg. Jalan Jend. Gatot Sub-  
roto Kav. 4, Jakarta 12930, Indonesia  
Tel: 021-520-2577

### KOREA

**Yamaha Music Korea Ltd.**  
8F, 9F, Dongsung Bldg. 158-9 Samsung-Dong,  
Kangnam-Gu, Seoul, Korea  
Tel: 02-3467-3300

### MALAYSIA

**Yamaha Music (Malaysia) Sdn., Bhd.**  
No.8, Jalan Perbandaran, Kelana Jaya, 47301  
Petaling Jaya, Selangor, Malaysia  
Tel: 03-78030900

### PHILIPPINES

**Yupangco Music Corporation**  
339 Gil J. Puyat Avenue, P.O. Box 885 MCPO,  
Makati, Metro Manila, Philippines  
Tel: 819-7551

### SINGAPORE

**Yamaha Music (Asia) Private Limited**  
Block 202 Hougang Street 21, #02-00,  
Singapore 530202, Singapore  
Tel: 65-6747-4374

### TAIWAN

**Yamaha Music & Electronics Taiwan Co.,Ltd.**  
3F, No.6, Section 2 Nan-Jing East Road, Taipei,  
Taiwan R.O.C.  
Tel: 02-2511-8688

### THAILAND

**Siam Music Yamaha Co., Ltd.**  
3, 4, 15 and 16th floor, Siam Motors Building,  
891/1 Rama 1 Road, Wangmai,  
Pathumwan, Bangkok 10330, Thailand  
Tel: 02-215-2622

### VIETNAM

**Yamaha Music Vietnam Company Limited**  
15th Floor, Nam A Bank Tower, 201-203 Cach  
Mang Thang Tam St., Ward 4, Dist.3,  
Ho Chi Minh City, Vietnam  
Tel: +84-8-3818-1122

### OTHER ASIAN COUNTRIES

**Yamaha Corporation  
Market Development Section**  
Nakazawa-cho 10-1, Naka-ku, Hamamatsu,  
Japan 430-8650  
Tel: +81-53-460-2312

## OCEANIA

### AUSTRALIA

**Yamaha Music Australia Pty. Ltd.**  
Level 1, 99 Queensbridge Street, Southbank,  
Victoria 3006, Australia  
Tel: 3-9693-5111

### NEW ZEALAND

**Music Works LTD**  
P.O. BOX 6246 Wellesley, Auckland 4680,  
New Zealand  
Tel: 9-634-0099

### COUNTRIES AND TRUST TERRITORIES IN PACIFIC OCEAN

**Yamaha Corporation  
Market Development Section**  
Nakazawa-cho 10-1, Naka-ku, Hamamatsu,  
Japan 430-8650  
Tel: +81-53-460-2312



Yamaha Global Site  
<http://www.yamaha.com/>  
Yamaha Downloads  
<http://download.yamaha.com/>

C.S.G., Digital Musical Instruments Division  
© 2013 Yamaha Corporation

309PO\*\*\* \*-\*\*A0  
Printed in Japan

ZG72800



ZG72800